

Proximity Sensor with a Long Screw Length



- Increased tightening strength. Cable protectors provided as a standard feature.
- Increased indicator visibility. A milled section for wrench grip on all models.



Be sure to read *Safety Precautions* on page 9.

Ordering Information

Sensors

DC 2-Wire Models

Appearance		Sensing distance			Model	
					Operation mode	
					NO	NC
Shielded 	M12	3 mm		E2E2-X3D1 2M *	E2E2-X3D2 2M	
	M18	7 mm		E2E2-X7D1 2M *	E2E2-X7D2 2M	
	M30	10 mm		E2E2-X10D1 2M *	E2E2-X10D2 2M	
Unshielded 	M12	8 mm		E2E2-X8MD1 2M *	E2E2-X8MD2 2M	
	M18	14 mm		E2E2-X14MD1 2M *	E2E2-X14MD2 2M	
	M30	20 mm		E2E2-X20MD1 2M *	E2E2-X20MD2 2M	

* Models with different frequencies are also available. The model numbers are E2E2-X□D15 (example: E2E2-X3D15).
Note: Orders for DC 2-Wire Models have been discontinued at the end of March 2023.

DC 3-Wire Models

Appearance		Sensing distance			Model	
					Operation mode	
					NO	NC
Shielded 	M12	2 mm		E2E2-X2C1 2M	E2E2-X2C2 2M	
	M18	5 mm		E2E2-X5C1 2M	E2E2-X5C2 2M	
	M30	10 mm		E2E2-X10C1 2M	E2E2-X10C2 2M	
Unshielded 	M12	5 mm		E2E2-X5MC1 2M	E2E2-X5MC2 2M	
	M18	10 mm		E2E2-X10MC1 2M	E2E2-X10MC2 2M	
	M30	18 mm		E2E2-X18MC1 2M	E2E2-X18MC2 2M	

Note: Orders for DC 3-Wire Models have been discontinued at the end of March 2022.

AC 2-Wire Models

Appearance		Sensing distance			Model	
					Operation mode	
					NO	NC
Shielded 	M12	2 mm		E2E2-X2Y1 2M *1	E2E2-X2Y2 2M	
	M18	5 mm		E2E2-X5Y1 2M *1	E2E2-X5Y2 2M	
	M30	10 mm		E2E2-X10Y1 2M	E2E2-X10Y2 2M	
Unshielded 	M12	5 mm		E2E2-X5MY1 2M *1	E2E2-X5MY2 2M	
	M18	10 mm		E2E2-X10MY1 2M	E2E2-X10MY2 2M	
	M30	18 mm		E2E2-X18MY1 2M	E2E2-X18MY2 2M	

*1. M4 Connector Models are also available. The model number is E2E2-X□(M)Y□-M4 (example: E2E2-X5Y1-M4). Not sold within Japan.

Accessories (Order Separately)

Mounting Brackets

Protective Covers

Sputter Protective Covers

Ratings and Specifications

E2E2-X□□ DC 2-Wire Models

Item	Size Shielding Model	M12		M18		M30	
		Shielded	Unshielded	Shielded	Unshielded	Shielded	Unshielded
		E2E2-X3D□	E2E2-X8MD□	E2E2-X7D□	E2E2-X14MD□	E2E2-X10D□	E2E2-X20MD□
Sensing distance		3 mm±10%	8 mm±10%	7 mm±10%	14 mm±10%	10 mm±10%	20 mm±10%
Set distance *1		0 to 2.4 mm	0 to 6.4 mm	0 to 5.6 mm	0 to 11.2 mm	0 to 8 mm	0 to 16 mm
Differential travel		10% max. of sensing distance					
Sensing object		Ferrous metal (The sensing distance decreases with non-ferrous metal. Refer to <i>Engineering Data</i> on page 5.)					
Standard sensing object		Iron, 12 × 12 × 1 mm	Iron, 30 × 30 × 1 mm	Iron, 18 × 18 × 1 mm	Iron, 30 × 30 × 1 mm	Iron, 30 × 30 × 1 mm	Iron, 54 × 54 × 1 mm
Response frequency *2		1 kHz	800 Hz	500 Hz	400 Hz		100 Hz
Power supply voltage (operating voltage range)		12 to 24 VDC (10 to 30 VDC), ripple (p-p): 10% max.					
Leakage current		0.8 mA max.					
Control output	Switching capacity	3 to 100 mA					
	Residual voltage	3 V max. (Load current: 100 mA, Cable length: 2 m)					
Indicators		D1 Models: Operation indicator (red) and setting indicator (green) D2 Models: Operation indicator (red)					
Operation mode (with sensing object ap- proaching)		D1 Models: NO Refer to the timing charts under <i>I/O Circuit Diagrams</i> on page 8 for details. D2 Models: NC					
Protection circuits		Surge absorber, Load short-circuit protection					
Ambient temperature		Operating/Storage: -25 to 70°C (with no icing or condensation)					
Ambient humidity		Operating/Storage: 35% to 95% (with no condensation)					
Temperature influence		±10% max. of sensing distance at 23°C in the temperature range of -25 to 70°C					
Voltage influence		±1% max. of sensing distance at rated voltage in the rated voltage ±15% range					
Insulation resistance		50 MΩ min. (at 500 VDC) between current-carrying parts and case					
Dielectric strength		1000 VAC, 50/60 Hz for 1 minute between current-carrying parts and case					
Vibration resistance (destruction)		10 to 55 Hz, 1.5-mm double amplitude for 2 hours each in X, Y, and Z directions					
Shock resistance (destruction)		1,000 m/s ² 10 times each in X, Y, and Z directions					
Degree of protection		IEC IP67, in-house standard for oil resistance					
Connection method		Pre-wired Models (Standard cable length: 2 m)					
Weight (packed state)		Approx. 65 g		Approx. 150 g		Approx. 210 g	
Material- als	Case	Brass					
	Sensing surface	PBT					
	Clamping nuts	Nickel-plated brass					
	Toothed washer	Zinc-plated iron					
Accessories		Instruction sheet					

*1. Use the E2E2 within the range in which the setting indicator (green LED) is ON (except D2 Models).

*2. The response frequency is an average value. Measurement conditions are as follows: standard sensing object, a distance of twice the standard sensing object, and a set distance of half the sensing distance.

E2E2-X□□ DC 3-Wire Models

Item	Size Shielding Model	M12		M18		M30	
		Shielded	Unshielded	Shielded	Unshielded	Shielded	Unshielded
		E2E2-X2C□	E2E2-X5MC□	E2E2-X5C□	E2E2-X10MC□	E2E2-X10C□	E2E2-X18MC□
Sensing distance		2 mm±10%	5 mm±10%	5 mm±10%	10 mm±10%	10 mm±10%	18 mm±10%
Set distance		0 to 1.6 mm	0 to 4 mm	0 to 4 mm	0 to 8 mm	0 to 8 mm	0 to 14 mm
Differential travel		10% max. of sensing distance					
Sensing object		Ferrous metal (The sensing distance decreases with non-ferrous metal. Refer to <i>Engineering Data</i> on page 5.)					
Standard sensing object		Iron, 12 × 12 × 1 mm	Iron, 15 × 15 × 1 mm	Iron, 18 × 18 × 1 mm	Iron, 30 × 30 × 1 mm	Iron, 30 × 30 × 1 mm	Iron, 54 × 54 × 1 mm
Response frequency *1		1.5 kHz	400 Hz	600 Hz	200 Hz	400 Hz	100 Hz
Power supply voltage (operating voltage range) *2		12 to 24 VDC (10 to 30 VDC), ripple (p-p): 10% max.					
Leakage current		13 mA max.					
Control output	Load current	NPN open-collector output, 200 mA max. (30 VDC max.)					
	Residual voltage	2 V max. (Load current: 200 mA, Cable length: 2 m)					
Indicators		Operation indicator (red)					
Operation mode (with sensing object approaching)		C1 Models: NO Refer to the timing charts under <i>I/O Circuit Diagrams</i> on page 8 for details. C2 Models: NC					
Protection circuits		Reverse polarity protection, Surge absorber, Load short-circuit protection					
Ambient temperature		Operating/Storage: -40 to 85°C (with no icing or condensation)					
Ambient humidity		Operating/Storage: 35% to 95% (with no condensation)					
Temperature influence		±15% max. of sensing distance at 23°C in the temperature range of -40 to 85°C ±10% max. of sensing distance at 23°C in the temperature range of -25 to 70°C					
Voltage influence		±1% max. of sensing distance at rated voltage in the rated voltage ±15% range					
Insulation resistance		50 MΩ min. (at 500 VDC) between current-carrying parts and case					
Dielectric strength		1,000 VAC, 50/60 Hz for 1 minute between current carry parts and case					
Vibration resistance (destruction)		10 to 55 Hz, 1.5-mm double amplitude for 2 hours each in X, Y, and Z directions					
Shock resistance (destruction)		1,000 m/s ² 10 times each in X, Y, and Z directions					
Degree of protection		IEC IP67, in-house standard for oil resistance					
Connection method		Pre-wired Models (Standard cable length: 2 m) and Connector Models					
Weight (packed state)		Approx. 75 g		Approx. 160 g		Approx. 220 g	
Materials	Case	Brass					
	Sensing surface	PBT					
	Clamping nuts	Nickel-plated brass					
	Toothed washer	Zinc-plated iron					
Accessories		Instruction sheet					

*1. The response frequency is an average value. Measurement conditions are as follows: standard sensing object, a distance of twice the standard sensing object, and a set distance of half the sensing distance.

*2. A full-wave rectification power supply of 24 VDC ±20% (average value) can be used.

E2E2-X□Y□ AC 2-Wire Models

Item	Size Shielding Model	M12		M18		M30	
		Shielded	Unshielded	Shielded	Unshielded	Shielded	Unshielded
		E2E2-X2Y□	E2E2-X5MY□	E2E2-X5Y□	E2E2-X10MY□	E2E2-X10Y□	E2E2-X18MY□
Sensing distance		2 mm±10%	5 mm±10%	5 mm±10%	10 mm±10%	10 mm±10%	18 mm±10%
Set distance		0 to 1.6 mm	0 to 4 mm	0 to 4 mm	0 to 8 mm	0 to 8 mm	0 to 14 mm
Differential travel		10% max. of sensing distance					
Sensing object		Ferrous metal (The sensing distance decreases with non-ferrous metal. Refer to <i>Engineering Data</i> on page 5.)					
Standard sensing object		Iron, 12 × 12 × 1 mm	Iron, 15 × 15 × 1 mm	Iron, 18 × 18 × 1 mm	Iron, 30 × 30 × 1 mm	Iron, 30 × 30 × 1 mm	Iron, 54 × 54 × 1 mm
Response frequency		25 Hz					
Power supply voltage (operating voltage range) *1		24 to 240 VAC (20 to 264 VAC), 50/60 Hz					
Leakage current		1.7 mA max.					
Control output	Load current *2	5 to 200 mA		5 to 300 mA			
	Residual voltage	Refer to <i>Engineering Data</i> on page 5.					
Indicators		Operation indicator (red)					
Operation mode (with sensing object approaching)		Y1 Models: NO Refer to the timing charts under <i>I/O Circuit Diagrams</i> on page 8 for details. Y2 Models: NC					
Ambient temperature *1, 2		Operating/Storage: -40 to 85°C (with no icing or condensation)					
Ambient humidity		Operating/Storage: 35% to 95% (with no condensation)					
Temperature influence		±15% max. of sensing distance at 23°C in the temperature range of -40 to 85°C, ±10% max. of sensing distance at 23°C in the temperature range of -25 to 70°C					
Voltage influence		±1% max. of sensing distance at rated voltage in the rated voltage ±15% range					
Insulation resistance		50 MΩ min. (at 500 VDC) between current-carrying parts and case					
Dielectric strength		4,000 VAC, 50/60 Hz for 1 minute between current carry parts and case					
Vibration resistance (destruction)		10 to 55 Hz, 1.5-mm double amplitude for 2 hours each in X, Y, and Z directions					
Shock resistance (destruction)		1,000 m/s ² 10 times each in X, Y, and Z directions					
Degree of protection		IEC IP67, in-house standard for oil resistance					
Connection method		Pre-wired Models (Standard cable length: 2 m) and Connector Models					
Weight (packed state)		Approx. 65 g		Approx. 150 g		Approx. 210 g	
Materials	Case	Brass					
	Sensing surface	PBT					
	Clamping nuts	Nickel-plated brass					
	Toothed washer	Zinc-plated iron					
Accessories		Instruction sheet					

*1. When supplying 24 VAC to any of the above models, make sure that the operating ambient temperature range is at least -25°C to 85°C.

*2. When using an M18 or M30 Connector Model at an ambient temperature between 70 and 85°C, make sure that the Sensor has a control output (load current) of 5 to 200 mA max.

Engineering Data (Reference Value)

Sensing Area Shielded Models E2E2-X□D□

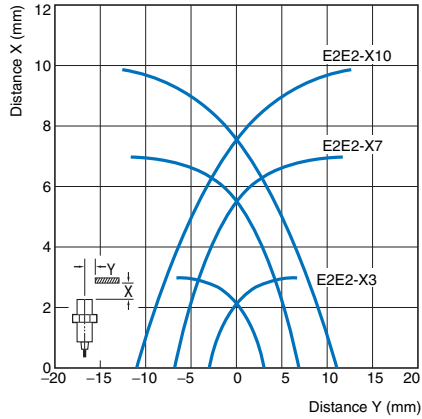

E2E2-X□C□/-X□Y□

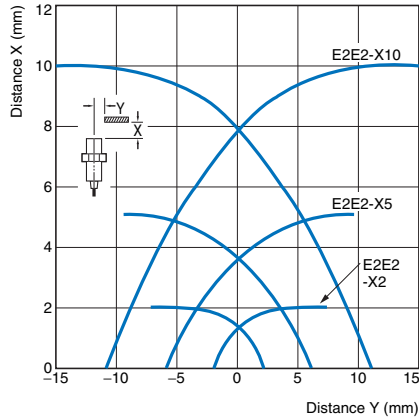

Unshielded Models E2E2-X□MD□

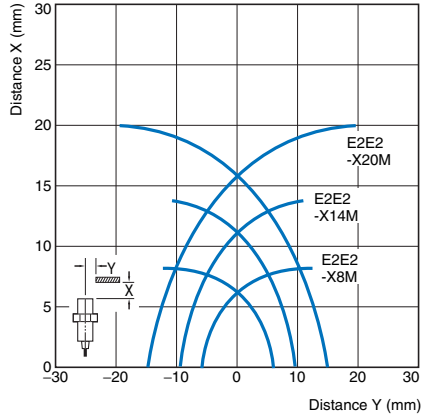

E2E2-X□MC□/-X□MY□

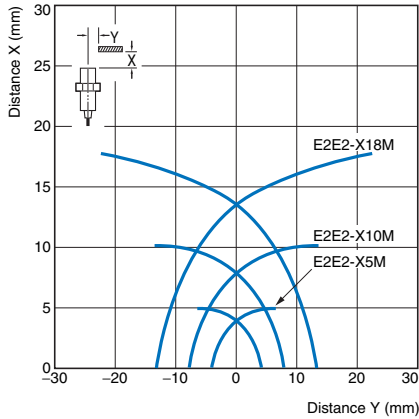

Leakage Current E2E2-X□D□

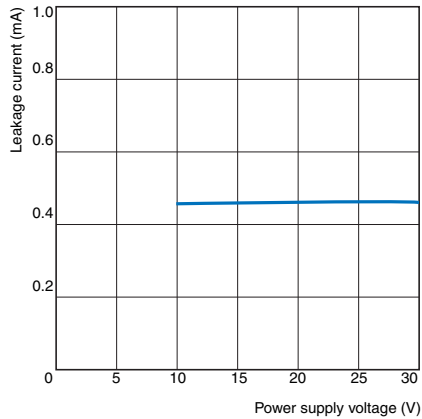

E2E2-X□Y□

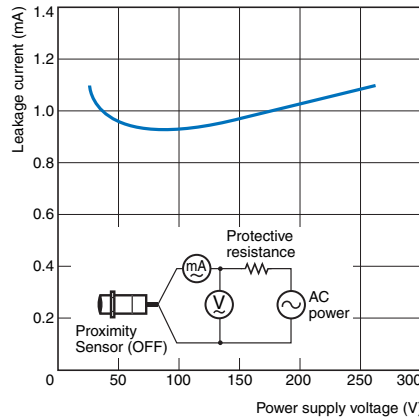

Residual Output Voltage E2E2-X□D□

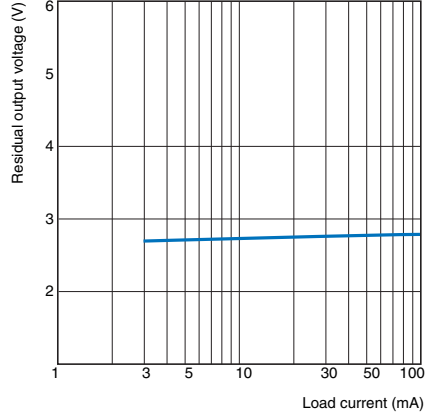

E2E2-X□Y□

at 24 VAC

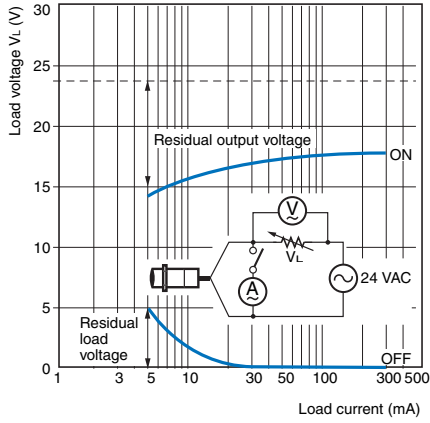

E2E2-X□Y□

at 100 VAC

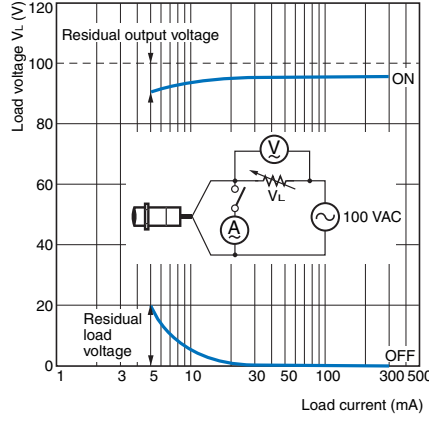

E2E2-X□Y□

at 200 VAC

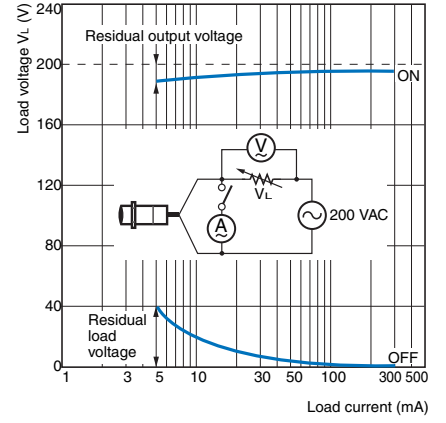

Influence of Sensing Object Size and Material

E2E2-X3D□

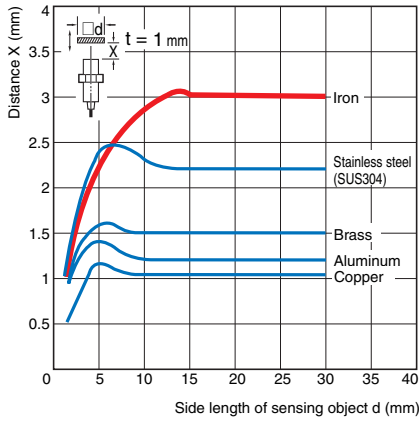

E2E2-X7D□

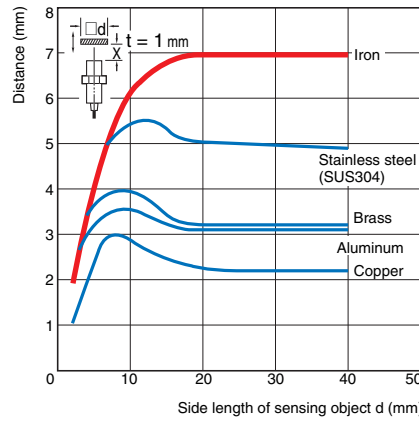

E2E2-X10D□

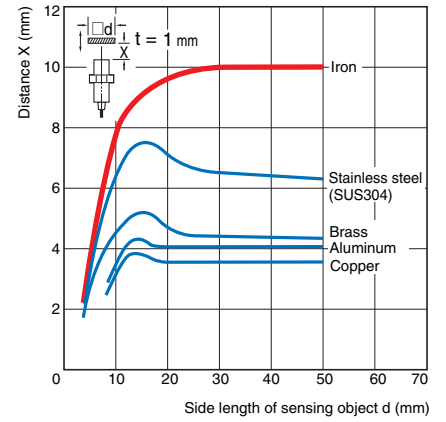

E2E2-X8MD□

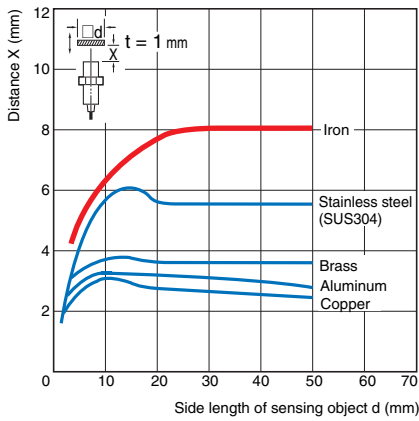

E2E2-X14MD□

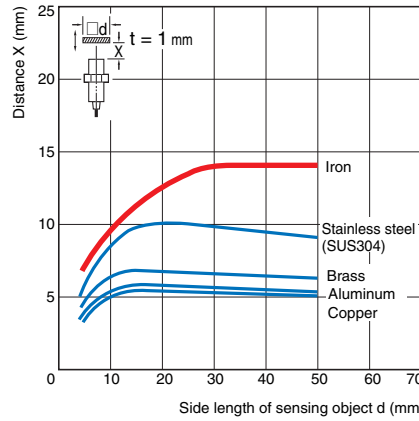

E2E2-X20MD□

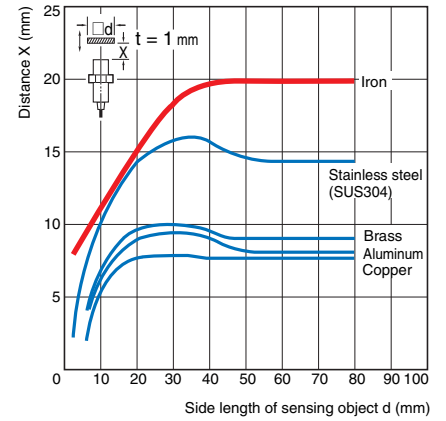

E2E2-X2C□/-X2Y□



E2E2-X5C□/-X5Y□



E2E2-X10C□/-X10Y□

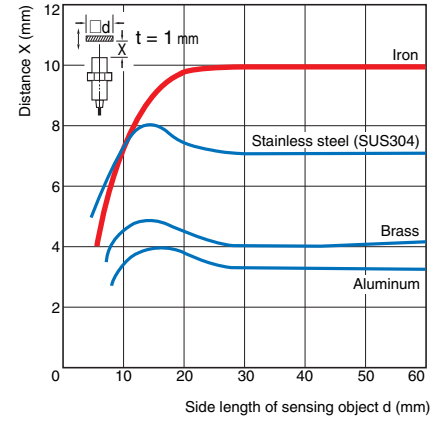

E2E2-X5MC□/-X5MY□

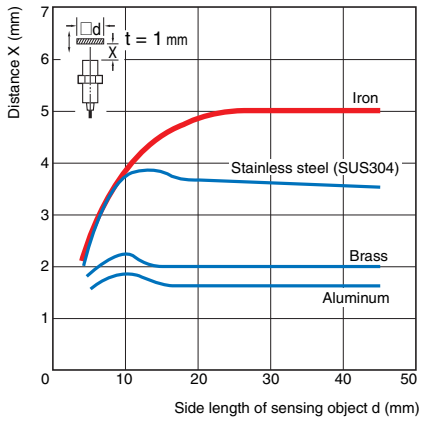

E2E2-X10MC□/-X10MY□



E2E2-X18MC□/-X18MY□

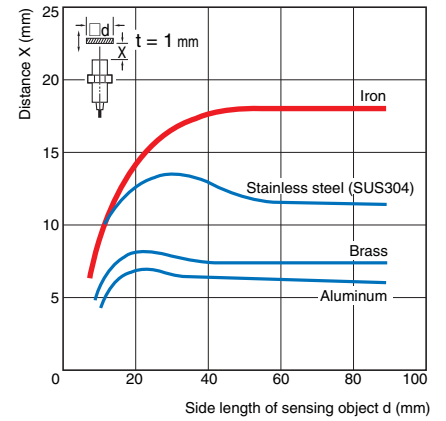

I/O Circuit Diagrams

DC 2-Wire Models

Operation mode	Model	Timing Charts	Output circuit
NO	E2E2-X3D1 E2E2-X7D1 E2E2-X10D1 E2E2-X8MD1 E2E2-X14MD1 E2E2-X20MD1		<p>Note: The load can be connected to either the +V or 0 V side.</p>
NC	E2E2-X3D2 E2E2-X7D2 E2E2-X10D2 E2E2-X8MD2 E2E2-X14MD2 E2E2-X20MD2		<p>Note: The load can be connected to either the +V or 0 V side.</p>

DC 3-Wire Models

Operation mode	Model	Timing Charts	Output circuit
NO	E2E2-X2C1 E2E2-X5C1 E2E2-X10C1 E2E2-X5MC1 E2E2-X10MC1 E2E2-X18MC1		
NC	E2E2-X2C2 E2E2-X5C2 E2E2-X10C2 E2E2-X5MC2 E2E2-X10MC2 E2E2-X18MC2		

AC 2-Wire Models

Operation mode	Model	Timing Charts	Output circuit
NO	E2E2-X□Y1 E2E2-X□MY1		
NC	E2E2-X□Y2 E2E2-X□MY2		
NO	E2E2-X□Y1-M4 E2E2-X□MY1-M4		

Safety Precautions

WARNING

This product is not designed or rated for ensuring safety of persons either directly or indirectly.



Do not use it for such purposes.

Precautions for Correct Use

Do not use this product under ambient conditions that exceed the ratings.

● Design

Influence of Surrounding Metal

When mounting the Sensor within a metal panel, ensure that the clearances given in the following table are maintained.

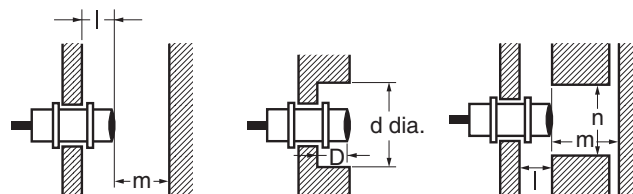

(Unit: mm)

Model		Item	M12	M18	M30
DC 2-Wire Models E2E2-X□D□	Shielded	l	0	0	0
		d	12	18	30
		D	0	0	0
		m	8	20	40
		n	18	27	45
	Unshielded	l	15	22	30
		d	40	70	90
		D	15	22	30
		m	20	40	70
		n	40	70	90
DC 3-Wire Models E2E2-X□C□ AC 2-Wire Models E2E2-X□Y□	Shielded	l	0	0	0
		d	12	18	30
		D	0	0	0
		m	8	20	40
		n	18	27	45
	Unshielded	l	15	22	30
		d	40	55	90
		D	15	22	30
		m	20	40	70
		n	36	54	90

Mutual Interference

When installing Sensors face-to-face or side-by-side, ensure that the minimum distances given in the following table are maintained.

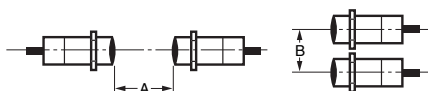

Mutual Interference

(Unit: mm)

Model	Item	M12	M18	M30	
DC 2-Wire Models E2E2-X□D□	Shielded	A	30 (20)	50 (30)	100 (50)
		B	20	35 (18)	70 (35)
	Unshielded	A	120 (60)	200 (100)	300 (100)
		B	100 (50)	110 (60)	200 (100)
DC 3-Wire Models E2E2-X□C□	Shielded	A	30	50	100
		B	20	35	70
AC 2-Wire Models E2E2-X□Y□	Unshielded	A	120	200	300
		B	100	110	200

Note: Values in parentheses apply to Sensors operating at different frequencies.

Relationship between Sizes and Models

Size	Model		
M12	Shielded	E2E2-X3D□ E2E2-X2C□ E2E2-X2Y□	
	Unshielded	E2E2-X8MD□ E2E2-X5MC□ E2E2-X5MY□	
		M18	Shielded
Unshielded			E2E2-X14MD□ E2E2-X10MC□ E2E2-X10MY□
	M30		Shielded
		Unshielded	E2E2-X20MD□ E2E2-X18MC□ E2E2-X18MY□

● Mounting



tening Torque

Do not tighten the nut with excessive force.

A washer must be used with the nut.

The following strengths assume washers are being used.

Model	Torque
M12	30 N·m
M18	70 N·m
M30	180 N·m

(Unit: mm)

Dimensions

Unless otherwise specified, the tolerance class IT16 is used for dimensions in this data sheet.

Shielded



Unshielded

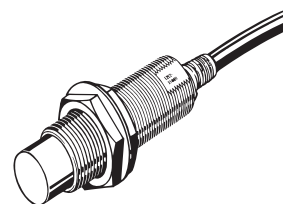

E2E2-X3D□/E2E2-X2C□/E2E2-X2Y□

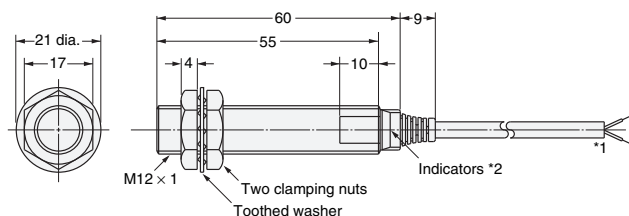

- *1. 4-dia. vinyl-insulated round cable with 2 conductors (Conductor cross section: 0.3 mm², Insulator diameter: 1.3 mm), Standard length: 2 m
- 4-dia. vinyl-insulated round cable with 3 conductors (Conductor cross section: 0.3 mm², Insulator diameter: 1.3 mm), Standard length: 2 m
- The cable can be extended to up to 200 m (Separate metal conduit.)
- *2. D Models: Operation indicator (red) and setting indicator (green), C/Y Models: Operation indicator (red)

E2E2-X8MD□/E2E2-X5MC□/E2E2-X5MY□

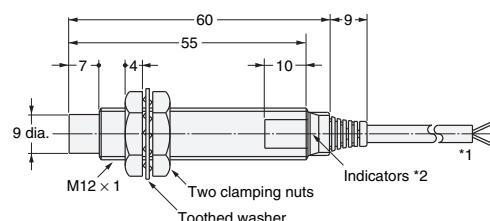

- *1. 4-dia. vinyl-insulated round cable with 2 conductors (Conductor cross section: 0.3 mm², Insulator diameter: 1.3 mm), Standard length: 2 m
- 4-dia. vinyl-insulated round cable with 3 conductors (Conductor cross section: 0.3 mm², Insulator diameter: 1.3 mm), Standard length: 2 m
- The cable can be extended to up to 200 m (Separate metal conduit.)
- *2. D Models: Operation indicator (red) and setting indicator (green), C/Y Models: Operation indicator (red)

E2E2-X7D□/E2E2-X5C□/E2E2-X5Y□

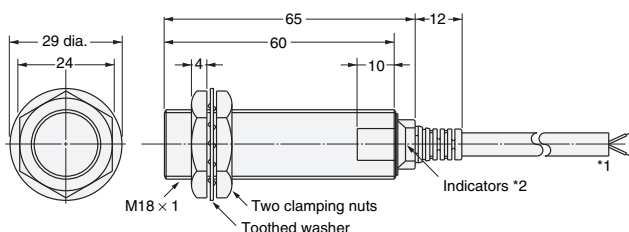

- *1. 6-dia. vinyl-insulated round cable with 2 conductors (Conductor cross section: 0.5 mm², Insulator diameter: 1.9 mm), Standard length: 2 m
- 6-dia. vinyl-insulated round cable with 3 conductors (Conductor cross section: 0.5 mm², Insulator diameter: 1.9 mm), Standard length: 2 m
- The cable can be extended to up to 200 m (Separate metal conduit.)
- *2. D Models: Operation indicator (red) and setting indicator (green), C/Y Models: Operation indicator (red)

E2E2-X14MD□/E2E2-X10MC□/E2E2-X10MY□

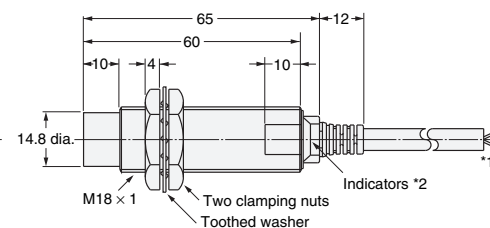

- *1. 6-dia. vinyl-insulated round cable with 2 conductors (Conductor cross section: 0.5 mm², Insulator diameter: 1.9 mm), Standard length: 2 m
- 6-dia. vinyl-insulated round cable with 3 conductors (Conductor cross section: 0.5 mm², Insulator diameter: 1.9 mm), Standard length: 2 m
- The cable can be extended to up to 200 m (Separate metal conduit.)
- *2. D Models: Operation indicator (red) and setting indicator (green), C/Y Models: Operation indicator (red)

E2E2-X10D□/E2E2-X10C□/E2E2-X10Y□

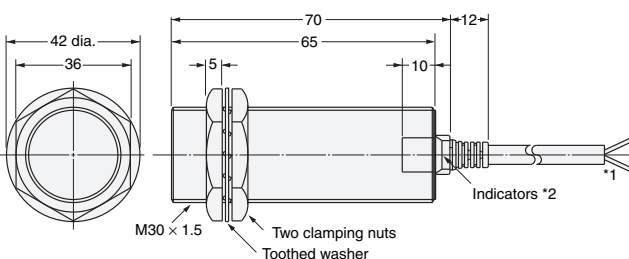

- *1. 6-dia. vinyl-insulated round cable with 2 conductors (Conductor cross section: 0.5 mm², Insulator diameter: 1.9 mm), Standard length: 2 m
- 6-dia. vinyl-insulated round cable with 3 conductors (Conductor cross section: 0.5 mm², Insulator diameter: 1.9 mm), Standard length: 2 m
- The cable can be extended to up to 200 m (Separate metal conduit.)
- *2. D Models: Operation indicator (red) and setting indicator (green), C/Y Models: Operation indicator (red)

E2E2-X20MD□/E2E2-X18MC□/E2E2-X18MY□

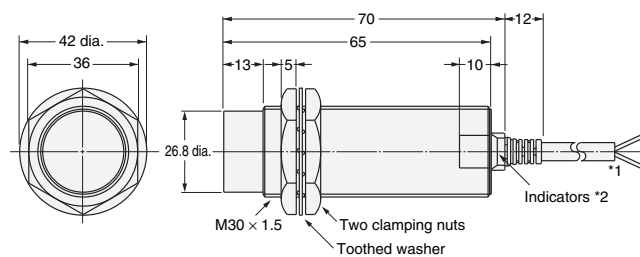

- *1. 6-dia. vinyl-insulated round cable with 2 conductors (Conductor cross section: 0.5 mm², Insulator diameter: 1.9 mm), Standard length: 2 m
- 6-dia. vinyl-insulated round cable with 3 conductors (Conductor cross section: 0.5 mm², Insulator diameter: 1.9 mm), Standard length: 2 m
- The cable can be extended to up to 200 m (Separate metal conduit.)
- *2. D Models: Operation indicator (red) and setting indicator (green), C/Y Models: Operation indicator (red)

Mounting Hole Dimensions

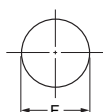

Dimension	M12	M18	M30
F (mm)	12.5 ^{+0.5} ₀ dia.	18.5 ^{+0.5} ₀ dia.	30.5 ^{+0.5} ₀ dia.

- Note 1. Two clamping nuts and one toothed washer are provided with each Sensors.
- 2. The model number is laser-marked on the cable section and milled section.

Shielded

E2E2-X2Y□-M4

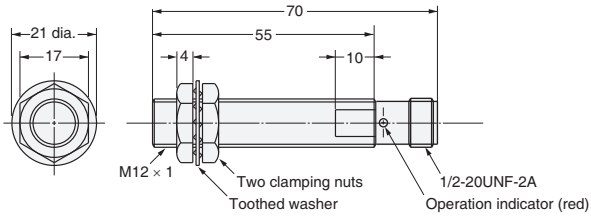

Unshielded

E2E2-X5MY□-M4

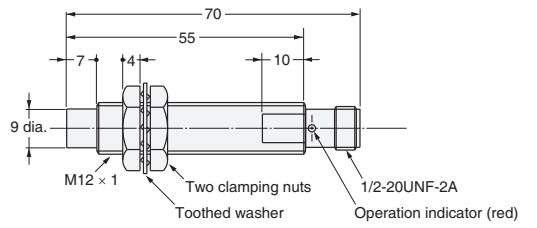

E2E2-X5Y□-M4

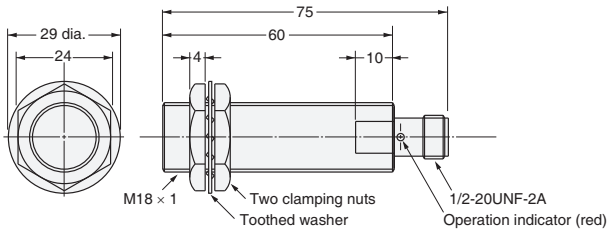

Mounting Hole Dimensions

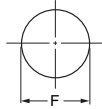

Dimension	M12	M18
F (mm)	12.5 ^{+0.5} ₀ dia.	18.5 ^{+0.5} ₀ dia.

Note 1. Two clamping nuts and one toothed washer are provided with each Sensors.

Connector Pin Arrangement

M4 Connector model

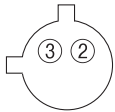

Terms and Conditions Agreement

Read and understand this catalog.

Please read and understand this catalog before purchasing the products. Please consult your OMRON representative if you have any questions or comments.

Warranties.

(a) Exclusive Warranty. Omron's exclusive warranty is that the Products will be free from defects in materials and workmanship for a period of twelve months from the date of sale by Omron (or such other period expressed in writing by Omron). Omron disclaims all other warranties, express or implied.

(b) Limitations. OMRON MAKES NO WARRANTY OR REPRESENTATION, EXPRESS OR IMPLIED, ABOUT NON-INFRINGEMENT, MERCHANTABILITY OR FITNESS FOR A PARTICULAR PURPOSE OF THE PRODUCTS. BUYER ACKNOWLEDGES THAT IT ALONE HAS DETERMINED THAT THE PRODUCTS WILL SUITABLY MEET THE REQUIREMENTS OF THEIR INTENDED USE.

Omron further disclaims all warranties and responsibility of any type for claims or expenses based on infringement by the Products or otherwise of any intellectual property right. (c) Buyer Remedy. Omron's sole obligation hereunder shall be, at Omron's election, to (i) replace (in the form originally shipped with Buyer responsible for labor charges for removal or replacement thereof) the non-complying Product, (ii) repair the non-complying Product, or (iii) repay or credit Buyer an amount equal to the purchase price of the non-complying Product; provided that in no event shall Omron be responsible for warranty, repair, indemnity or any other claims or expenses regarding the Products unless Omron's analysis confirms that the Products were properly handled, stored, installed and maintained and not subject to contamination, abuse, misuse or inappropriate modification. Return of any Products by Buyer must be approved in writing by Omron before shipment. Omron Companies shall not be liable for the suitability or unsuitability or the results from the use of Products in combination with any electrical or electronic components, circuits, system assemblies or any other materials or substances or environments. Any advice, recommendations or information given orally or in writing, are not to be construed as an amendment or addition to the above warranty.

See <http://www.omron.com/global/> or contact your Omron representative for published information.

Limitation on Liability: Etc.

OMRON COMPANIES SHALL NOT BE LIABLE FOR SPECIAL, INDIRECT, INCIDENTAL, OR CONSEQUENTIAL DAMAGES, LOSS OF PROFITS OR PRODUCTION OR COMMERCIAL LOSS IN ANY WAY CONNECTED WITH THE PRODUCTS, WHETHER SUCH CLAIM IS BASED IN CONTRACT, WARRANTY, NEGLIGENCE OR STRICT LIABILITY.

Further, in no event shall liability of Omron Companies exceed the individual price of the Product on which liability is asserted.

Suitability of Use.

Omron Companies shall not be responsible for conformity with any standards, codes or regulations which apply to the combination of the Product in the Buyer's application or use of the Product. At Buyer's request, Omron will provide applicable third party certification documents identifying ratings and limitations of use which apply to the Product. This information by itself is not sufficient for a complete determination of the suitability of the Product in combination with the end product, machine, system, or other application or use. Buyer shall be solely responsible for determining appropriateness of the particular Product with respect to Buyer's application, product or system. Buyer shall take application responsibility in all cases.

NEVER USE THE PRODUCT FOR AN APPLICATION INVOLVING SERIOUS RISK TO LIFE OR PROPERTY OR IN LARGE QUANTITIES WITHOUT ENSURING THAT THE SYSTEM AS A WHOLE HAS BEEN DESIGNED TO ADDRESS THE RISKS, AND THAT THE OMRON PRODUCT(S) IS PROPERLY RATED AND INSTALLED FOR THE INTENDED USE WITHIN THE OVERALL EQUIPMENT OR SYSTEM.

Programmable Products.

Omron Companies shall not be responsible for the user's programming of a programmable Product, or any consequence thereof.

Performance Data.

Data presented in Omron Company websites, catalogs and other materials is provided as a guide for the user in determining suitability and does not constitute a warranty. It may represent the result of Omron's test conditions, and the user must correlate it to actual application requirements. Actual performance is subject to the Omron's Warranty and Limitations of Liability.

Change in Specifications.

Product specifications and accessories may be changed at any time based on improvements and other reasons. It is our practice to change part numbers when published ratings or features are changed, or when significant construction changes are made. However, some specifications of the Product may be changed without any notice. When in doubt, special part numbers may be assigned to fix or establish key specifications for your application. Please consult with your Omron's representative at any time to confirm actual specifications of purchased Product.

Errors and Omissions.

Information presented by Omron Companies has been checked and is believed to be accurate; however, no responsibility is assumed for clerical, typographical or proofreading errors or omissions.

2024.11

In the interest of product improvement, specifications are subject to change without notice.

OMRON Corporation
Industrial Automation Company

<http://www.ia.omron.com/>

(c)Copyright OMRON Corporation 2024 All Right Reserved.