

Vision Sensor FH/FHV Series Vision System

User's manual for Communication Settings

FH-2□□□/FH-2□□□-□□

FH-5□□□/FH-5□□□-□□

FH-L□□□/FH-L□□□-□□

FHV7□-□□□□□-C

FHV7□-□□□□□-S□□/FHV7□-□□□□□-S□□-□□

FHV7□-□□□□□-H□□/FHV7□-□□□□□-H□□-□□



NOTE

- All rights reserved.
- No part of this publication may be reproduced, stored in a retrieval system, or transmitted, in any form, or by any means, mechanical, electronic, photocopying, recording, or otherwise, without the prior written permission of OMRON.
- No patent liability is assumed with respect to the use of the information contained herein. Moreover, because OMRON is constantly striving to improve its high-quality products, the information contained in this manual is subject to change without notice. Every precaution has been taken in the preparation of this manual. Nevertheless, OMRON assumes no responsibility for errors or omissions.

Neither is any liability assumed for damages resulting from the use of the information contained in this publication.

Trademarks

- Sysmac and SYSMAC are trademarks or registered trademarks of OMRON Corporation in Japan and other countries for OMRON factory automation products.
- This software is based in part on the work of the Independent JPEG Group.
- Microsoft, Windows, Windows Vista, Excel, and Visual Basic are either registered trademarks or trademarks of Microsoft Corporation in the United States and other countries.
- Intel, Core and Pentium are trademarks of Intel Corporation in the U.S. and/or other countries.
- EtherCAT® is registered trademark and patented technology, licensed by Beckhoff Automation GmbH, Germany.
- ODVA, CIP, CompoNet, DeviceNet, and EtherNet/IP are trademarks of ODVA.
- The SD, SDHC, microSD, and microSDHC logos are trademarks of SD-3C, LLC.



- QR Code is a registered trademark of DENSO WAVE INCORPORATED.
- MELSEC is a registered trademarks of Mitsubishi Electric Corporation.

Other company names and product names in this document are the trademarks or registered trademarks of their respective companies.

Copyrights

Microsoft product screen shots reprinted with permission from Microsoft.

Introduction

Thank you for purchasing the FH/FHV Series.

This manual contains information that is necessary to use the FH/FHV Series.

Please read this manual and make sure you understand the functionality and performance of the FH/FHV Series before you attempt to use it in a control system.

Keep this manual in a safe place where it will be available for reference during operation.

Intended Audience

This manual is intended for the following personnel, who must also have knowledge of electrical systems (an electrical engineer or the equivalent).

- Personnel in charge of introducing FA systems.
- Personnel in charge of designing FA systems.
- Personnel in charge of installing and maintaining FA systems.
- Personnel in charge of managing FA systems and facilities.

Applicable Products

This manual covers the following products.

- FH-2□□□
- FH-2□□□-□□
- FH-5□□□
- FH-5□□□-□□
- FH-L□□□
- FH-L□□□-□□
- FHV7□-□□□□

Part of the specifications and restrictions are given in other manuals. Refer to Relevant Manuals on *Relevant Manuals* on page 2 and *Related Manuals* on page 19.

Relevant Manuals

The following table provides the relevant manuals for the FH/FHV Series.

Read all of the manuals that are relevant to your system configuration and application before you use the FH/FHV Series.

Purpose of use	Manual							
	Basic information			FHV Series Smart Camera Setup Manual	FH/FHV Series Vision System Processing Item Function Reference Manual	FH Series Vision System Macro Customize Functions Programming Manual	FH Series Vision System User's Manual for Communications Settings	FH/FHV Series Vision System Operation Manual for Systemac Studio
	FH Series Vision System Hardware Setup Manual	FH/FHV Series Vision System User's Manual						
Overview of FH series	●	●						
Overview of FHV series	●		●					
Setup and Wiring								
EtherCAT								
EtherNet/IP								
PROFINET		●	●					
Ethernet								
RS-232C								
Parallel interface								
Setup the communication setting of Sensor Controller								●
EtherCAT								
EtherNet/IP	●	●	●				●	
PROFINET								
Ethernet								
RS-232C								
Parallel interface								
Setup the Sensor Controller								●
EtherCAT								
EtherNet/IP								
PROFINET	●						●	
Ethernet								
RS-232C								
Parallel interface								

Purpose of use	Manual						
	Basic information			FH/FHV Series Vision System Processing Item Function Reference Manual	FH Series Vision System Macro Customize Functions Programming Manual	FH/FHV Series Vision System User's Manual for Communications Settings	FH/FHV Series Vision System Operation Manual for Sysmac Studio
	FH/FHV Series Vision System User's Manual	FH Series Vision System Hardware Setup Manual	FHV Series Smart Camera Setup Manual				
Create and Set the Scene							●
EtherCAT							
EtherNet/IP							
PROFINET	●			●			
Ethernet							
RS-232C							
Parallel interface							
Optimizing the Scene Flow							
EtherCAT							
EtherNet/IP							
PROFINET				●	●		
Ethernet							
RS-232C							
Parallel interface							
Connecting the Controller							●
EtherCAT							
EtherNet/IP							
PROFINET	●	●	●			●	
Ethernet							
RS-232C							
Parallel interface							
Using Helpful Functions							●
EtherCAT							
EtherNet/IP							
PROFINET	●						
Ethernet							
RS-232C							
Parallel interface							
Troubleshooting and Problem Solving	●						

Manual Structure

Page Structure

The following page structure is used in this manual.

The diagram illustrates the structure of a manual page. It shows a page with a main heading '4 Installation and Wiring' at the top right. Below it is a sub-heading '4-3 Mounting Units'. Underneath that is a section heading '4-3-1 Connecting Controller Components'. The main content area contains a numbered step '1' with a procedure description and an illustration of units being joined. Below this is another numbered step '2' with a procedure description and an illustration of sliders being moved. A 'Precautions for Correct Use' section follows, marked with a warning icon. At the bottom left is the manual name 'NJ-series CPU Unit Hardware User's Manual (W500)' and at the bottom right is the page number '4-9'. Annotations on the right side identify these elements as Level 1 heading, Level 2 heading, Level 3 heading, a page tab, and special information. Annotations on the left side identify the sub-heading, a step in a procedure, and the manual name.

Level 1 heading — 4 Installation and Wiring

Level 2 heading — 4-3 Mounting Units

Level 3 heading — 4-3-1 Connecting Controller Components

Gives the current headings.

Page tab — 4

Gives the number of the main section.

Level 2 heading — 4-3 Mounting Units

Level 3 heading — 4-3-1 Connecting Controller Components

A step in a procedure — 1 Join the Units so that the connectors fit exactly.

Indicates a procedure.

Special information — Precautions for Correct Use

Icons indicate precautions, additional information, or reference information.

Manual name — NJ-series CPU Unit Hardware User's Manual (W500)

Note This illustration is provided only as a sample. It may not literally appear in this manual.

Special Information

Special information in this manual is classified as follows:



Precautions for Safe Use

Precautions on what to do and what not to do to ensure safe usage of the product.



Precautions for Correct Use

Precautions on what to do and what not to do to ensure proper operation and performance.



Additional Information

Additional information to read as required.

This information is provided to increase understanding or make operation easier.

Conventions Used in This Manual

Use of Quotation Marks and Brackets

In this manual, menus and other items are indicated as follows.

Bold	Menu	Indicates the menu names or processing items shown in the menu bar.
<i>Italic</i>	Item name	Indicates the item names displayed on the screen.

Sections in This Manual

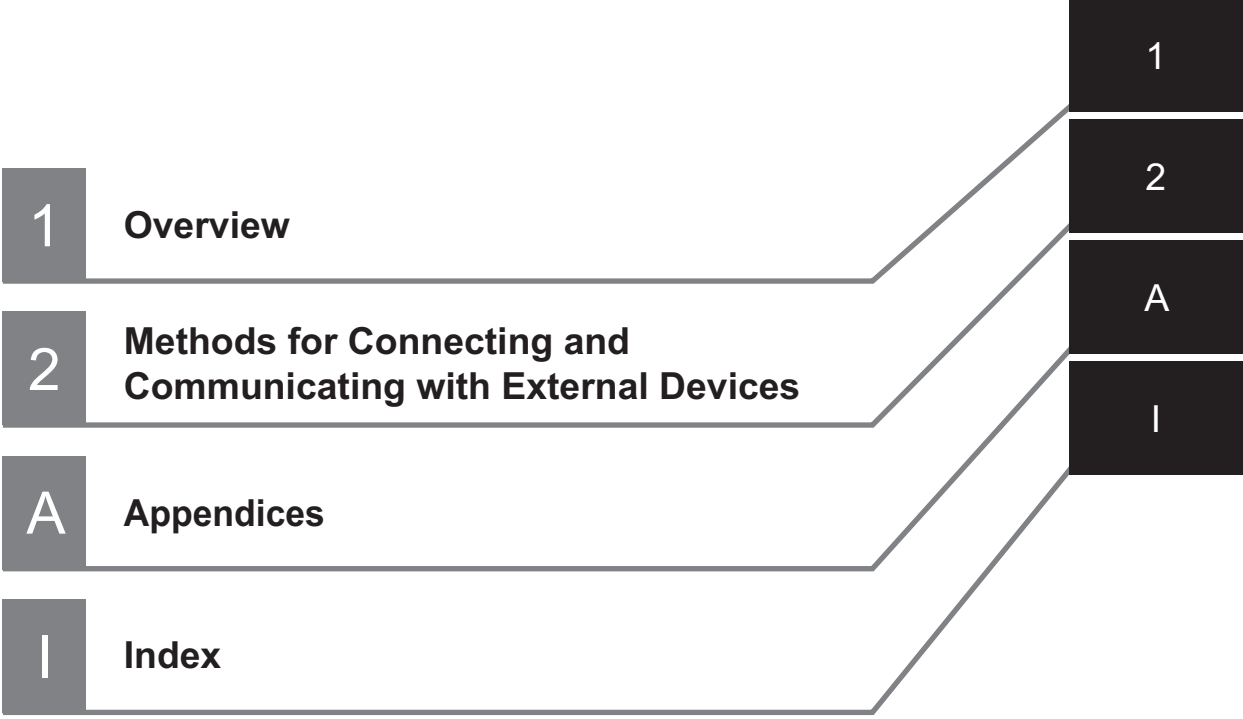

CONTENTS

Introduction	1
Intended Audience	1
Applicable Products	1
Relevant Manuals	2
Manual Structure	4
Page Structure	4
Special Information	5
Conventions Used in This Manual	5
Sections in This Manual	7
Terms and Conditions Agreement	12
Warranty, Limitations of Liability	12
Application Considerations	13
Disclaimers	13
Safety Precautions	15
Precautions for Safe Use	16
Precautions for Correct Use	17
Regulations and Standards	18
Related Manuals	19
Revision History	21

Section 1 Overview

1-1 Introduction	1-2
1-2 Confirming the System Configuration	1-3
1-2-1 System Configuration	1-3
1-3 Communicating with an External Device	1-4
1-3-1 Basic Control Operations of the Sensor Controller	1-4
1-3-2 Communications between the Sensor Controller and an External Device	1-5
1-3-3 Control Methods for the Sensor Controller	1-7
1-3-4 Communication Protocols for Communicating with the Sensor Controller	1-9
1-3-5 Saving Sensor Controller Data to an External Device	1-11
1-4 Control Methods Using an External Device	1-13
1-4-1 Control with Control Signals and Status Signals	1-13
1-4-2 Command/Response Method	1-16
1-4-3 Data Output after Measurements	1-17
1-5 Setting Procedures for Communications	1-27
1-5-1 Communications Setup Procedures	1-27
1-5-2 Communications Protocols and Communications Modules	1-28
1-6 Differences in Specifications Based on the Communications Protocol	1-30
1-6-1 List of Supported Signals by Communications Protocol	1-30
1-6-2 Restrictions when Using Different Communication Protocols Simultaneously	1-32

1-6-3	Restrictions in Communication Protocols by Operation Mode	1-32
1-6-4	Models being Compatible with Communication Protocol	1-33

Section 2 Methods for Connecting and Communicating with External Devices

2-1	EtherCAT Connections	2-4
2-1-1	Introduction to EtherCAT	2-4
2-1-2	Structure of CAN Application Protocol over EtherCAT (CoE)	2-7
2-1-3	EtherCAT Slave Information Files (ESI Files)	2-8
2-1-4	Transitions of Communications States	2-9
2-1-5	Process Data Objects (PDOs)	2-10
2-1-6	Service Data Objects (SDOs)	2-13
2-1-7	Communications between Master and Slaves for EtherCAT	2-14
2-1-8	Communication Method of Sensor Controller Connected by EtherCAT	2-15
2-1-9	Communications Settings	2-20
2-1-10	Communications Module Settings (Startup Settings)	2-22
2-1-11	Communication Specifications Settings	2-23
2-1-12	Output Data Settings (Processing Item Registration)	2-28
2-1-13	Setting Output Data (Numerical Values/Character Strings)	2-31
2-1-14	EtherCAT Network Configuration Settings	2-37
2-1-15	Communication Test	2-38
2-1-16	I/O Ports by Area (PDO Mapping) and Memory Allocation	2-39
2-1-17	I/O Signals	2-45
2-1-18	Measurement Results for which Output is Possible (Fieldbus Data Output)	2-50
2-1-19	Command List	2-51
2-1-20	Measurement Trigger Input	2-55
2-1-21	Command Response Processing	2-56
2-1-22	Data Output	2-59
2-1-23	Timing Chart	2-61
2-1-24	EtherCAT Troubleshooting	2-65
2-1-25	Sysmac Error Status	2-67
2-1-26	Sysmac Device Features	2-85
2-1-27	Object Dictionary	2-88
2-2	Communicating by PLC Link	2-128
2-2-1	Communications Processing Flow	2-128
2-2-2	Communications Settings	2-130
2-2-3	Communications Module Settings (Startup Settings)	2-131
2-2-4	Communication Specifications Settings	2-133
2-2-5	Output Data Settings (Processing Item Registration)	2-155
2-2-6	Setting Output Data (Numerical Values and Character Strings)	2-159
2-2-7	Testing Communications	2-165
2-2-8	Memory Allocation	2-170
2-2-9	I/O Signals	2-173
2-2-10	Output Items	2-176
2-2-11	Command List	2-177
2-2-12	Command Response Processing	2-181
2-2-13	Data Output	2-184
2-2-14	Timing Chart	2-186
2-2-15	PLC Link Troubleshooting	2-189
2-3	Communicating by EtherNet/IP	2-192
2-3-1	Introduction to EtherNet/IP	2-192
2-3-2	Data Exchange with EtherNet/IP	2-193
2-3-3	EtherNet/IP Communications	2-196
2-3-4	Communications Processing Flow	2-197
2-3-5	Communications Settings	2-199
2-3-6	Communications Module Settings (Startup Settings)	2-200
2-3-7	Communication Specifications Settings	2-201
2-3-8	Setting Tag Data Link	2-208
2-3-9	Output Data Settings (Processing Item Registration)	2-213
2-3-10	Setting Output Data (Numerical Values and Character Strings)	2-217

2-3-11	Testing Communications	2-223
2-3-12	Memory Allocation.....	2-226
2-3-13	I/O Signals.....	2-235
2-3-14	Output Items.....	2-239
2-3-15	Command List.....	2-240
2-3-16	Command Response Processing.....	2-244
2-3-17	Data Output.....	2-248
2-3-18	Timing Chart.....	2-250
2-3-19	Communicating with the Sensor Controller using EtherNet/IP Message Communications ...	2-253
2-3-20	Example for Command Settings	2-256
2-3-21	EtherNet/IP Troubleshooting	2-258
2-4	Communicating by PROFINET	2-261
2-4-1	Overview of PROFINET	2-261
2-4-2	PROFINET Communications	2-265
2-4-3	Communications Processing Flow	2-266
2-4-4	Communications Settings	2-268
2-4-5	Communications Module Settings (Startup Settings).....	2-269
2-4-6	Communication Specifications Settings	2-270
2-4-7	IO Data Communication Settings.....	2-277
2-4-8	Output Data Settings (Processing Item Registration)	2-279
2-4-9	Setting Output Data (Numerical Values and Character Strings)	2-283
2-4-10	Testing Communications	2-289
2-4-11	Memory Allocation.....	2-292
2-4-12	I/O Signals.....	2-298
2-4-13	Output Items.....	2-302
2-4-14	Command List.....	2-303
2-4-15	Command Response Processing.....	2-306
2-4-16	Data Output.....	2-309
2-4-17	Timing Chart.....	2-311
2-4-18	PROFINET Troubleshooting	2-314
2-5	Non-procedure Communications	2-317
2-5-1	Communications Processing Flow	2-317
2-5-2	Communications Setup Procedures	2-318
2-5-3	Communications Module Settings (Startup Settings).....	2-319
2-5-4	Communications Specifications Settings	2-321
2-5-5	Output Data Settings (Processing Item Registration)	2-328
2-5-6	Output Data Settings (Numerical Values/Character Strings)	2-334
2-5-7	Testing Communications	2-342
2-5-8	Output Items.....	2-345
2-5-9	Command Formats	2-347
2-5-10	Command List.....	2-349
2-5-11	Output Format.....	2-353
2-5-12	Non-procedure Communications Troubleshooting.....	2-355
2-6	Parallel Communications	2-358
2-6-1	Communications Processing Flow	2-358
2-6-2	Communications Setup Procedures	2-360
2-6-3	Communications Module Settings (Startup Settings).....	2-361
2-6-4	Communications Specifications Settings	2-362
2-6-5	Output Data Settings (Processing Item Registration)	2-371
2-6-6	Output Data Settings (Numerical value/Judgment)	2-378
2-6-7	Testing Communications	2-383
2-6-8	I/O Signals.....	2-385
2-6-9	Output Items.....	2-396
2-6-10	Command Formats	2-398
2-6-11	Time Charts.....	2-403
2-6-12	Parallel Troubleshooting.....	2-416

Appendices

A-1	Command Control.....	A-2
A-1-1	Parameter Notation Examples for Command Control.....	A-2
A-1-2	Details of Commands Used in EtherCAT Communications	A-6

A-1-3	Command List	A-7
A-1-4	Command Details for PLC Link, EtherNet/IP, EtherCAT, and PROFINET	A-16
A-1-5	Non-procedure Command Details	A-81

Terms and Conditions Agreement

Warranty, Limitations of Liability

Warranties

● Exclusive Warranty

Omron's exclusive warranty is that the Products will be free from defects in materials and workmanship for a period of twelve months from the date of sale by Omron (or such other period expressed in writing by Omron). Omron disclaims all other warranties, express or implied.

● Limitations

OMRON MAKES NO WARRANTY OR REPRESENTATION, EXPRESS OR IMPLIED, ABOUT NON-INFRINGEMENT, MERCHANTABILITY OR FITNESS FOR A PARTICULAR PURPOSE OF THE PRODUCTS. BUYER ACKNOWLEDGES THAT IT ALONE HAS DETERMINED THAT THE PRODUCTS WILL SUITABLY MEET THE REQUIREMENTS OF THEIR INTENDED USE.

Omron further disclaims all warranties and responsibility of any type for claims or expenses based on infringement by the Products or otherwise of any intellectual property right.

● Buyer Remedy

Omron's sole obligation hereunder shall be, at Omron's election, to (i) replace (in the form originally shipped with Buyer responsible for labor charges for removal or replacement thereof) the non-complying Product, (ii) repair the non-complying Product, or (iii) repay or credit Buyer an amount equal to the purchase price of the non-complying Product; provided that in no event shall Omron be responsible for warranty, repair, indemnity or any other claims or expenses regarding the Products unless Omron's analysis confirms that the Products were properly handled, stored, installed and maintained and not subject to contamination, abuse, misuse or inappropriate modification. Return of any Products by Buyer must be approved in writing by Omron before shipment. Omron Companies shall not be liable for the suitability or unsuitability or the results from the use of Products in combination with any electrical or electronic components, circuits, system assemblies or any other materials or substances or environments. Any advice, recommendations or information given orally or in writing, are not to be construed as an amendment or addition to the above warranty.

See <http://www.omron.com/global/> or contact your Omron representative for published information.

Limitation on Liability; Etc

OMRON COMPANIES SHALL NOT BE LIABLE FOR SPECIAL, INDIRECT, INCIDENTAL, OR CONSEQUENTIAL DAMAGES, LOSS OF PROFITS OR PRODUCTION OR COMMERCIAL LOSS IN ANY

WAY CONNECTED WITH THE PRODUCTS, WHETHER SUCH CLAIM IS BASED IN CONTRACT, WARRANTY, NEGLIGENCE OR STRICT LIABILITY.

Further, in no event shall liability of Omron Companies exceed the individual price of the Product on which liability is asserted.

Application Considerations

Suitability of Use

Omron Companies shall not be responsible for conformity with any standards, codes or regulations which apply to the combination of the Product in the Buyer's application or use of the Product. At Buyer's request, Omron will provide applicable third party certification documents identifying ratings and limitations of use which apply to the Product. This information by itself is not sufficient for a complete determination of the suitability of the Product in combination with the end product, machine, system, or other application or use. Buyer shall be solely responsible for determining appropriateness of the particular Product with respect to Buyer's application, product or system. Buyer shall take application responsibility in all cases.

NEVER USE THE PRODUCT FOR AN APPLICATION INVOLVING SERIOUS RISK TO LIFE OR PROPERTY OR IN LARGE QUANTITIES WITHOUT ENSURING THAT THE SYSTEM AS A WHOLE HAS BEEN DESIGNED TO ADDRESS THE RISKS, AND THAT THE OMRON PRODUCT(S) IS PROPERLY RATED AND INSTALLED FOR THE INTENDED USE WITHIN THE OVERALL EQUIPMENT OR SYSTEM.

Programmable Products

Omron Companies shall not be responsible for the user's programming of a programmable Product, or any consequence thereof.

Disclaimers

Performance Data

Data presented in Omron Company websites, catalogs and other materials is provided as a guide for the user in determining suitability and does not constitute a warranty. It may represent the result of Omron's test conditions, and the user must correlate it to actual application requirements. Actual performance is subject to the Omron's Warranty and Limitations of Liability.

Change in Specifications

Product specifications and accessories may be changed at any time based on improvements and other reasons. It is our practice to change part numbers when published ratings or features are changed, or when significant construction changes are made. However, some specifications of the Product may

be changed without any notice. When in doubt, special part numbers may be assigned to fix or establish key specifications for your application. Please consult with your Omron's representative at any time to confirm actual specifications of purchased Product.

Errors and Omissions

Information presented by Omron Companies has been checked and is believed to be accurate; however, no responsibility is assumed for clerical, typographical or proofreading errors or omissions.

Safety Precautions

For details of Safety Precautions, refer to *Safety Precautions* in the *Vision System FH/FHV Series User's Manual (Cat. No. Z365)*.

Precautions for Safe Use

For details of Precautions for Safe Use, refer to *Precautions for Safe Use* in the *Vision System FH/FHV Series User's Manual (Cat. No. Z365)*.

Precautions for Correct Use

For details of Precautions for Correct Use, refer to *Precautions for Correct Use* in the *Vision System FH/FHV Series User's Manual (Cat. No. Z365)*.

Regulations and Standards

For details of Regulations and Standards, refer to *Regulations and Standards* in the *Vision System FH/FHV Series User's Manual (Cat. No. Z365)*.

Related Manuals

The followings are the manuals related to this manual. Use these manuals for reference.

Name of Manual	Cat. No.	Model	Purpose	Contents
Vision System FH Instruction Sheet	3648743-1	FH-2□□2 FH-2□□2-□□ FH-5□□2 FH-5□□2-□□	To confirm the safety and usage precautions of the Vision System FH series Sensor Controller.	Describes the definitions of basic terms, meaning of signal words, and precautions for correct use of FH series in the manual.
Vision System FH Instruction Sheet	3615791-1	FH-2□□□ FH-2□□□-□□ FH-5□□□ FH-5□□□-□□	To confirm the safety and usage precautions of the Vision System FH series Sensor Controller.	Describes the definitions of basic terms, meaning of signal words, and precautions for correct use of FH series in the manual.
Vision System FH-L Instruction Sheet	3615792-0	FH-L□□□ FH-L□□□-□□	To confirm the safety and usage precautions of the Vision System FH-Lite series Sensor Controller.	Describes the definitions of basic terms, meaning of signal words, and precautions for correct use of FH-L series in the manual.
Smart Camera FHV Instruction Sheet	3615629-0	FHV7□-□□□□□-□□□-□ □	To confirm the safety and usage precautions of the Smart Camera FHV7 series.	Describes the definitions of basic terms, the meaning of signal words, and precautions for correct use of FHV7 series in the manual.
Smart Camera Lighting Module FHV-LTM Instruction Sheet	3129276-4	FHV-LTM□□	To confirm the safety and usage precautions of the Smart camera lighting module FHV-LTM.	Describes the definitions of basic terms, the meaning of signal words, and precautions for correct use of the lighting module FHV-LTM in the manual.
Smart Camera Lens Module FHV-LEM-S Instruction Sheet	3128622-5	FHV-LEM-S□□	To confirm the safety and usage precautions of the Smart camera lens module FHV-LEM-S.	Describes the definitions of basic terms, the meaning of signal words, and precautions for correct use of the lens module FHV-LEM-S.
Smart Camera High-Speed Lens Module FHV-LEM-H Instruction Sheet	3129408-2	FHV-LEM-H□□	To confirm the safety and usage precautions of the Smart camera high-speed lens module FHV-LEM-H.	Describes the definitions of basic terms, the meaning of signal words, and precautions for correct use of the high-speed lens module FHV-LEM-H.
FHV Series Smart Camera Setup Manual	Z408	FHV7□-□□□□□-C FHV7□-□□□□□-S□□ FHV7□-□□□□□-S□□-□ □ FHV7□-□□□□□-H□□ FHV7□-□□□□□-H□□-□ □	When User want to know about the hardware specifications or to setup the Smart camera FHV series.	Describes FHV series specifications, dimensions, part names, I/O information, installation information, and wiring information.

Name of Manual	Cat. No..	Model	Purpose	Contents
Vision System FH/FHV Series User's Manual	Z365	FH-2□□□ FH-2□□□-□□ FH-5□□□	When User want to know about the FH/FHV series.	Describes the soft functions, setup, and operations to use FH/FHV series/
Vision System FH/FHV series Processing Item Function Reference Manual	Z341	FH-5□□□-□□ FH-L□□□ FH-L□□□-□□ FHV7□-□□□□□-C FHV7□-□□□□□-S□□ FHV7□-□□□□□-S□□-□	When User confirm the details of each processing items at the create the measurement flow or operate it.	Describes the software functions, settings, and operations for using FH/FHV series.
Vision System FH/FHV Series User's manual for Commu- nications Settings	Z342	□ FHV7□-□□□□□-H□□ FHV7□-□□□□□-H□□-□ □	When User confirm the setting of communication functions.	Describes the functions, settings, and communications methods for communication between FH/FHV series and PLCs. The following communications protocol are described. Parallel, PLC Link, EtherNet/IP, EtherCAT, and Non-procedure.
Vision System FH series Hardware Setup Manual	Z366	FH-2□□□ FH-2□□□-□□ FH-5□□□ FH-5□□□-□□ FH-L□□□ FH-L□□□-□□	When User want to know about the Hard-ware specifications or to setup the Sensor Controller of the Vision System FH series.	Describes FH series specifications, dimensions, part names, I/O information, installation information, and wiring information.
Vision System FH series Macro Customize Func- tions Programming Manual	Z367		When User operate or programming using Macro Customize functions.	Describes the functions, settings, and operations for using Macro Customize function of the FH series.
Vision System FH/FHV Series Operation Manual for Sysmac Studio	Z343	FH-2□□□ FH-2□□□-□□ FH-5□□□ FH-5□□□-□□ FHV7□-□□□□□-C FHV7□-□□□□□-S□□ FHV7□-□□□□□-S□□-□ □ FHV7□-□□□□□-H□□ FHV7□-□□□□□-H□□-□ □	When User connect to NJ/NX series via EtherCAT communication.	Describes the operating procedures for setting up and operating FH/FHV series Vision Sensors from the Sysmac Studio FH/FHV Tools.

Revision History

A manual revision code appears as a suffix to the catalog number on the front and back covers of the manual.

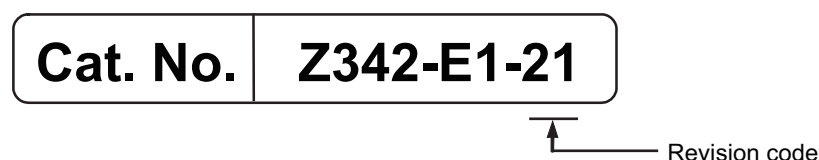

Rev. Code	Rev. Date	Revision Contents	Software Ver- sion
01	Jul. 2013	First edition	Ver. 5.0
02	Aug. 2013	Additions for software version upgrade	Ver. 5.10
03	Sep. 2013	Additions for software version upgrade	Ver. 5.12
04	Jan. 2014	Additions for software version upgrade	Ver. 5.2
05	Jun. 2014	Additions for software version upgrade	Ver. 5.3
06	Oct. 2015	Additions for software version upgrade	Ver. 5.5
07	Apr. 2016	Additions for software revision upgrade and description of FH-L series	Ver. 5.6
08	Mar. 2017	Corrected mistakes. Additions for software revision upgrade	Ver. 5.71
09	Jun. 2017	Additions for software revision upgrade	Ver. 5.72
10	Jul. 2018	Additions for software revision upgrade	Ver. 6.1
11	Nov. 2018	Additions for software revision upgrade	Ver. 6.2
12	Jul. 2019	Additions for software revision upgrade	Ver. 6.3
13	Nov. 2019	Corrected mistakes.	Ver. 6.3
14	Jun. 2020	Corrected mistakes.	Ver. 6.4
15	Nov. 2020	Corrected mistakes.	Ver. 6.4
16	Jan. 2022	Corrected mistakes.	Ver. 6.4
17	May 2022	Deleted the product information of FH-1000 / FH-3000 series. Additions for software revision upgrade - "2-2-7 Testing Communications" Corrected mistakes.	Ver. 6.5
18	Dec. 2022	Added FHV7X series. Revisions for update Related Manuals. Corrected mistakes.	Ver. 6.5
19	Mar. 2023	Corrected mistakes.	Ver. 6.5
20	Sep. 2023	Corrected mistakes.	Ver. 6.5
21	Mar. 2024	Added FH-2052, FH-2052-10, and FH-2052-20. Added FH-5052, FH-5052-10, and FH-5052-20. Added FH-5552, FH-5552-10, and FH-5552-20. Added FH-2051, FH-2051-10, and FH-2051-20. Added FH-5051, FH-5055-10, and FH-5051-20. Added FH-5551, FH-5551-10, and FH-5551-20. Additions for software revision upgrade. Corrected mistakes.	Ver. 6.55 Ver. 6.6

1

Overview

This section describes communication specifications to be used for communications between the Sensor Controller and an external device, and the Sensor Controller control methods.

1-1	Introduction	1-2
1-2	Confirming the System Configuration	1-3
1-2-1	System Configuration	1-3
1-3	Communicating with an External Device	1-4
1-3-1	Basic Control Operations of the Sensor Controller	1-4
1-3-2	Communications between the Sensor Controller and an External Device	1-5
1-3-3	Control Methods for the Sensor Controller	1-7
1-3-4	Communication Protocols for Communicating with the Sensor Controller	1-9
1-3-5	Saving Sensor Controller Data to an External Device	1-11
1-4	Control Methods Using an External Device	1-13
1-4-1	Control with Control Signals and Status Signals	1-13
1-4-2	Command/Response Method	1-16
1-4-3	Data Output after Measurements	1-17
1-5	Setting Procedures for Communications	1-27
1-5-1	Communications Setup Procedures	1-27
1-5-2	Communications Protocols and Communications Modules	1-28
1-6	Differences in Specifications Based on the Communications Protocol	1-30
1-6-1	List of Supported Signals by Communications Protocol	1-30
1-6-2	Restrictions when Using Different Communication Protocols Simultaneously	1-32
1-6-3	Restrictions in Communication Protocols by Operation Mode	1-32
1-6-4	Models being Compatible with Communication Protocol	1-33

1-1 Introduction

This section describes a basic overview of the Sensor Controller control methods and the communication specifications, which is required when the FH/FHV series communicate with an external device.

Confirming the System Configuration

This section describes the external device configuration that is required to perform measurement processing with the Sensor Controller.

For details, refer to *1-2 Confirming the System Configuration* on page 1-3.



Communicating with an External Device

This section describes the basic operations of the Sensor Controller, and the communication specifications between the Sensor Controller and an external device.

For Basic Flow of Communications and Signals, refer to *1-3-1 Basic Control Operations of the Sensor Controller* on page 1-4

- Process from Starting Measurements at the Sensor Controller to Data Output:
For details, refer to *1-3-2 Communications between the Sensor Controller and an External Device* on page 1-5.
- Sensor Controller Control Methods (Control Signals, Commands, etc.)
For details, refer to *1-3-3 Control Methods for the Sensor Controller* on page 1-7.
- Types of Communication Protocols for Communicating with the Sensor Controller
For details, refer to *1-3-4 Communication Protocols for Communicating with the Sensor Controller* on page 1-9.
- Moving Data between the Sensor Controller and an External Device
For details, refer to *1-3-5 Saving Sensor Controller Data to an External Device* on page 1-11.



Control Methods Using an External Device

This section describes the methods that you can use to control the Sensor Controller from an external device.

- Control with Control Signals and Status Signals
For details, refer to *1-4-1 Control with Control Signals and Status Signals* on page 1-13.
- Command/Response Method
For details, refer to *1-4-2 Command/Response Method* on page 1-16.
- Data Output after Measurements
For details, refer to *1-4-3 Data Output after Measurements* on page 1-17.



Setting Procedures for Communications

This section describes the procedures that are required to set up communications before starting communications between the Sensor Controller and an external device.

For details, refer to *1-5-1 Communications Setup Procedures* on page 1-27.



Differences in Specifications Based on the Communications Protocol

This section describes the types and differences of communication protocols that are used for communications with the Sensor Controller.

For details, refer to *1-5-2 Communications Protocols and Communications Modules* on page 1-28.

1-2 Confirming the System Configuration

The FH/FHV are Vision Systems that perform measurement processing through the Sensor Controller on measurement objects imaged by a Camera.

In a system configuration connected to an external device such as a PLC, measurement commands can be received from and measurement results can be output to the external device.

1-2-1 System Configuration

An overview of the FH/FHV series system configuration is shown below.

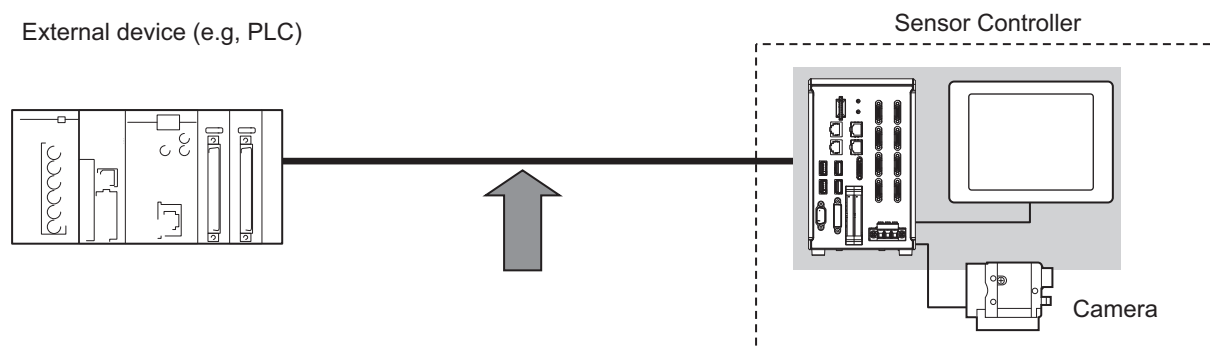

The Sensor Controller and an external device (PLC, etc.) are connected with a communication cable and communicate with each other using various communication protocols. For details of various communication protocols, refer to *Section 2 Methods for Connecting and Communicating with External Devices* on page 2-1.

An LCD monitor (BOX type only) for operation and monitoring and a camera are connected to the Sensor Controller unit.

For details, refer to *Vision System FH Series User's Manual (Cat. No. Z365)*, *Smart Camera FHV Series Setup Manual (Cat. No. Z408)*, and the Instruction Manual provided with each individual device.

Communications Protocol	Communication Cable
Parallel	Parallel I/O cable
PLC Link	Ethernet cable
	RS-232C cable
EtherNet/IP	Ethernet cable
EtherCAT	Ethernet cable
PROFINET	Ethernet cable
Non-procedure	Ethernet cable
	RS-232C cable

1-3 Communicating with an External Device

This section describes the communication specifications, control methods in communications, and settings required before starting communications with an external device.

1-3-1 Basic Control Operations of the Sensor Controller

The following figure shows basic communications, and the flow of signals and data, between an external device and the Sensor Controller.

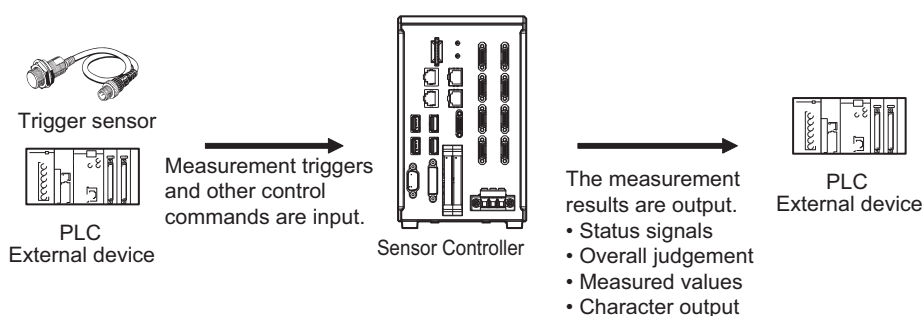

The following methods are used to exchange commands and data, between an external device and the Sensor Controller.

From an external device to the Sensor Controller

Type		Description
Control commands	Control signals (Input signal)	A measurement is performed when a measurement trigger (i.e., STEP signal: ON) is input. For information of control signals, refer to <i>Control Signals and Status Signals</i> on page 1-13.
	Communications command input	You can send commands to perform measurements, switch scene groups, or perform other tasks. The communication commands depend on the communication protocol used. For details, refer to the section for each communication protocol.

From the Sensor Controller to an external device

Type	Description
Status signals	When the Sensor Controller recognizes a control signal or communication command input and starts measurement processing, it reports its status to the external device using status signals such as a BUSY signal. For details, refer to <i>Control Signals and Status Signals</i> on page 1-13.
Overall judgment	NG is output whenever there is one or more NGs in the judgment results for multiple processing items. It can be output using the OR signal or the TJJ output parameter. For details, refer to <i>Control Signals and Status Signals</i> on page 1-13.
Measured values	The measured values for processing items are output. The items to be output need to be previously registered to the output data (data 0 to 7) using processing items for output. For details, refer to <i>Settings Required for Data Output</i> on page 1-20.

Type	Description
Character output	This is valid in PLC Link and Non-procedure communications protocols. You can output character strings and numbers read by processing items such as Character Inspection, Barcode, or 2D Code. You can also use commands to acquire them after a measurement is performed. For details, refer to <i>Items that can be Output as Output Data</i> on page 1-19.



Additional Information

You can also use the FTP server to obtain logged image files and logged data files saved in the Sensor Controller (including external storage) from a FTP client such as web browser.

1-3-2 Communications between the Sensor Controller and an External Device

Communications between the Sensor Controller and an external device are performed as shown below.

Here, describe how to start measurement with a communication command and to output data.

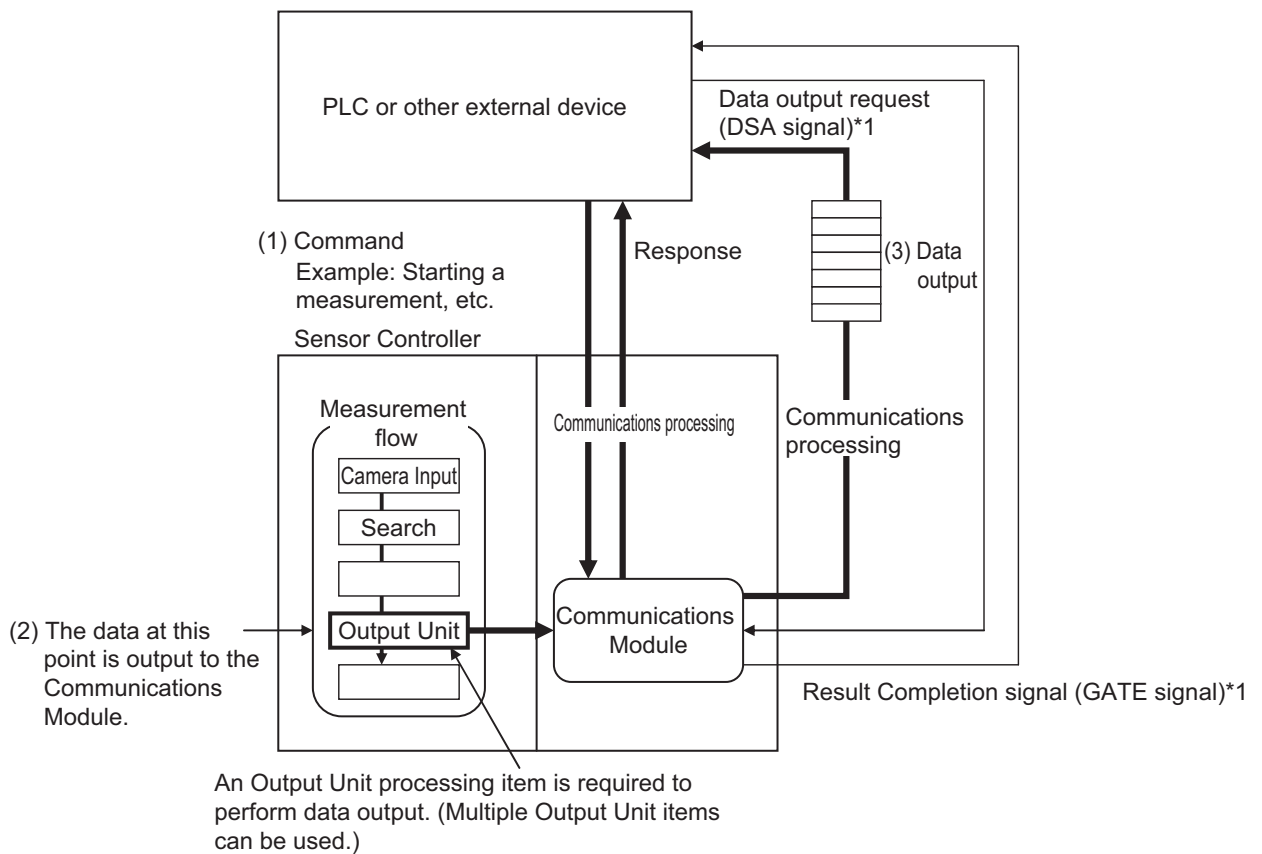

- (1) When the Sensor Controller receives a command from an external device such as a PLC, it performs the command and returns a response.
- (2) The measured data is output via the Communication module by the Output Unit (an abbreviation for *Results Output Unit*) placed in the measurement flow.
- (3) The measurement data is output when the Output Unit is performed and not when the measurement is completed. *2

- *1 When output control is set to handshaking (data output is controlled by the DSA and GATE signals).
For details, refer to *Control Signals and Status Signals* on page 1-13.
- *2 When handshaking is performed in the output control, the measurement data is held in the Communication module until a data output request (DSA signal) is received from the external device.
For details, refer to *Data Output Control with Handshaking* on page 1-24.



Precautions for Correct Use

To output data, you must place an Output Unit processing item in the measurement flow.
You can place multiple Output Unit processing items in the measurement flow.
For details, refer to *Settings Required for Data Output* on page 1-20.

1-3-3 Control Methods for the Sensor Controller

There are three methods below to control the Sensor Controller with an external device such as a PLC.

For details of each control method, refer to their corresponding section.

Control Methods

Method	Overview	Trigger type and area	Signal and area to be used
Control signals and status signals	Operation is controlled by the ON/OFF status of the Measurement Trigger Signal (STEP) and Command Request Bit (EXE).	ON/OFF status of the control signals and status signals	Control signals and status signals
Control with commands and responses	Operation is controlled by sending control commands. The results performed by the commands can be checked with responses from the Sensor Controller.	The control command code is stored in the I/O memory of the PLC and then the Request bit is turned ON.	PLC I/O memory (Command and Response Areas)
Data output after measurement	After measurement was performed, the previously specified measurement data is automatically output.	Not required (Automatically output after measurement)	PLC I/O memory (Data Output Area)

1. Control with Control Signals and Status Signals (Refer to 1-4-1 Control with Control Signals and Status Signals on page 1-13.)

Control and status check for the Sensor Controller is performed with the ON/OFF status of the control and status signals.

This method is best suited for basic operations such as measurement triggers or for checking the operating status of the Sensor Controller.

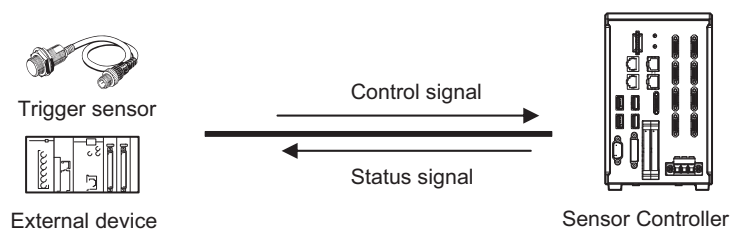

2. Control with Commands and Responses (Refer to 1-4-2 Command/Response Method on page 1-16.)

Control is performed by storing a control command and the response to it to the PLC's I/O memory. This method is best suited to send multiple commands to the Sensor Controller without using exclusive communication instructions for a PLC.

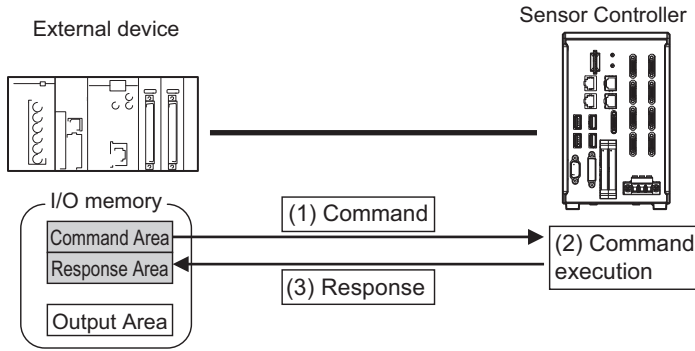

3. Data Output after Measurement (Refer to 1-4-3 Data Output after Measurements on page 1-17.)

After measurement was performed, the previously specified measurement data is automatically output to the PLC's specified I/O memory. This allows you to output measurement results from the Sensor Controller to the PLC automatically without sending data requests from the PLC.

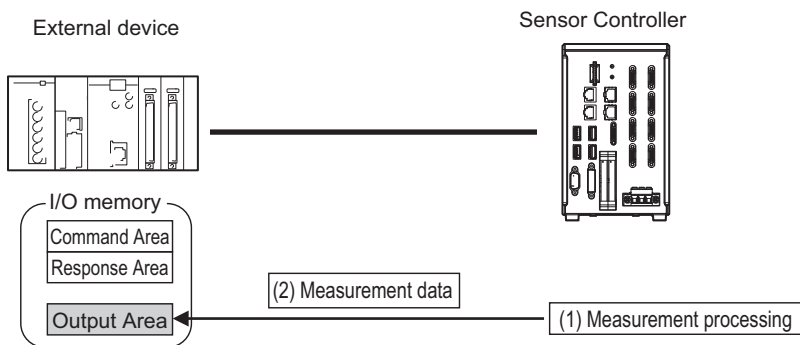

1-3-4 Communication Protocols for Communicating with the Sensor Controller

The Sensor Controller can be controlled using various communication protocols by an external device such as a PLC or a PC.

The communication protocols to control the Sensor Controller by an external device are described below.

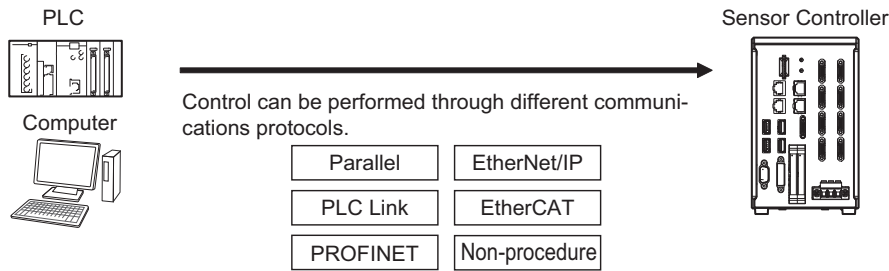

• **Applicable Communications Protocols**

The communication protocols and summary for each communication method available in the Sensor Controller are below.

OK: Supported, - : Not supported

Communication method	Communication protocol	Overview	Communication Cable Type		
			Parallel I/O	Ethernet	RS-232C
Contract input	Parallel	Using a combination of ON and OFF signals of multiple physical contacts exchanges data between an external device and the Sensor Controller.	OK	-	-
Frame transmission	Non-procedure	Without using any specific communication protocol, command frames are sent to the Sensor Controller and response frames are received from it. By sending and receiving data in ASCII or binary formats, data is communicated between an external device such as a PLC or a PC and the Sensor Controller.	-	OK	OK

Communication method	Communication protocol	Overview	Communication Cable Type		
			Parallel I/O	Ethernet	RS-232C
Data sharing	PLC Link	This is a communication protocol for the OMRON Vision System. Areas for control signals, Command, Response, and measurement data are assigned in the PLC's I/O memory, and data is communicated between the PLC and the Vision System by sharing them cyclically.	-	OK	OK
	EtherNet/IP	This is an open communication protocol. Tag data links are used to communicate with the Sensor Controller. Structure variables corresponding to the control signals, command data and response data, and measurement data are created on the PLC. Those variables are used as tags to input and output data via the tag data links to exchange data between the PLC and the Sensor Controller.*1	-	OK	-
	PROFINET	This is an open communication protocol. Areas for control signals, Command, Response, and measurement data are assigned in the PLC's I/O memory, and data is exchanged between the PLC and the Vision System by sharing the data via IO data CR.	-	OK	-
	EtherCAT	This is an open communication protocol. PDO (process data object) communications are used to communicate with the Sensor Controller. I/O ports corresponding to the control signals, command data, response data, and measurement data are prepared in advance, and the variables assigned to the I/O ports are used to input and output data via PDO communications to exchange data between the PLC and the Sensor Controller.	-	OK	-

*1. When a CJ series PLC is connected, specify each area in the I/O memory.

1-3-5 Saving Sensor Controller Data to an External Device

In addition to sending and receiving data via a communication protocol, you can also save data in the Sensor Controller to an external device using the methods described below.

For details, refer to the *Vision System FH/FHV Series User's Manual (Cat. No. Z365)*.

Connecting the FH/FHV as an External Drive

In addition to the Sensor Controller's built-in RAM disk, you can directly save various types of data such as scene data, scene group data, logged data, and logged images to the external media below.

- For external storage, refer to *Using External Storage Devices* in the *Vision System FH/FHV Series User's Manual (Cat. No. Z365)*.

Data can be saved directly to a USB flash drive or SD memory card inserted into the slot on the Sensor Controller.

- For network drive, refer to the *Shared folder on a computer connected to the network* in the *Vision System FH/FHV Series User's Manual (Cat. No. Z365)*.

You can save data directly to a shared folder on a computer connected via Ethernet.

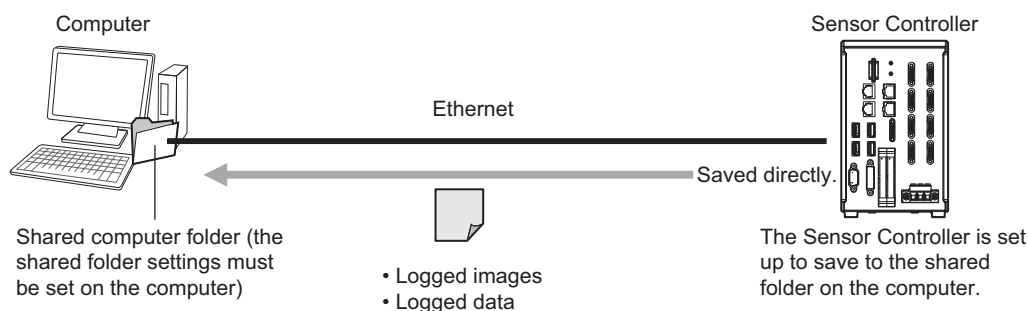

- For data transfer (FTP server), refer to the *Saving Data to an External Device* in the *Vision System FH/FHV Series User's Manual (Cat. No. Z365)*.

You can move logged image files and other data saved in the Sensor Controller's RAM disk or a USB flash drive to a computer via Ethernet.

The computer needs to have an FTP client function to access the Sensor Controller. The computer cannot be accessed directly from the Sensor Controller.

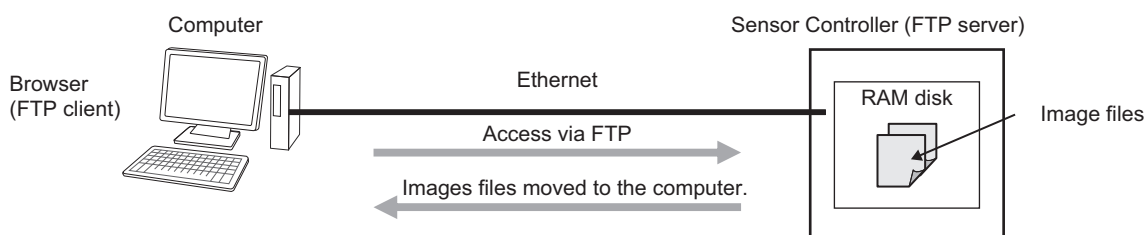

This enables you to move logged images off of the Sensor Controller's RAM disk before it becomes full.

- For remote operation over a network, refer to the *Remotely Operating the Controller (Remote Operation)* in the *Vision System FH/FHV Series User's Manual (Cat. No. Z365)*.
If more than one Sensor Controller is connected via Ethernet, a computer (FZ tool) connected to the same Ethernet network can operate and monitor all the Sensor Controllers at once.

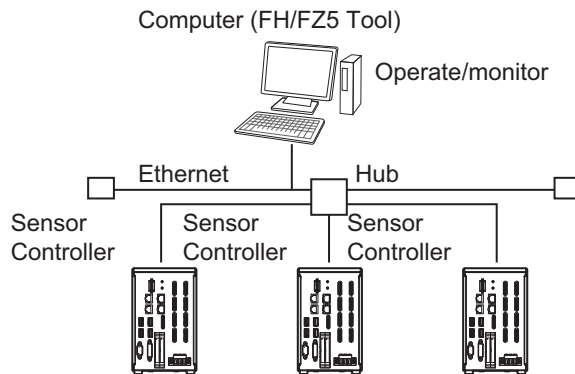

1-4 Control Methods Using an External Device

This section describes how to control the Sensor Controller from an external device such as a PLC.

1-4-1 Control with Control Signals and Status Signals

Control and status check for the Sensor Controller is performed with the ON and OFF status of the control and status signals.

A PLC inputs measurement triggers or other commands as control signals.

The operating status of the Sensor Controller, judgment results, and other status information can be checked with status signals output from the Sensor Controller.

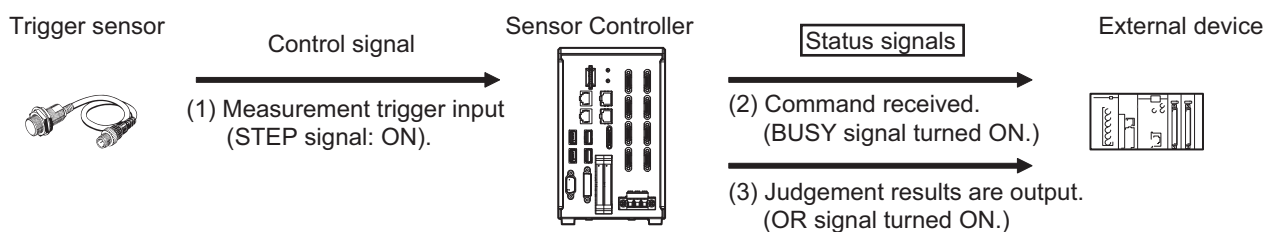

- (1) The external device turns the STEP signal ON to input a measurement trigger to the Sensor Controller.
- (2) When the Sensor Controller identifies that the STEP signal is turned ON, it outputs the BUSY signal to notify the external device and starts measurement.
- (3) When the Sensor Controller completes the measurement, it outputs the judgment results on the OR signal to notify the external device.

Control Signals and Status Signals

The signal types that are input and output to the Sensor Controller as control and status signals are described below.

● Input Signals (External Device (PLC, etc.) to Sensor Controller)

Signal	Name	Function
EXE Command Request	Control Command Execution Signal	This is turned ON when the PLC will issue a command to the Sensor Controller.
Trigger	Measure Bit	This is turned ON when measurement will be performed.
STEP	Measure Bit	This is turned ON when measurement will be performed.
DSA (Used only for handshaking output control) Result Set Request	Data Output Request Signal	During handshaking, the user (PLC) uses this signal to request to output data output results performed in the measurement flow to external from the Sensor Controller.
ERCLR Error Clear	Error Clear Bit	Clears the error signal (ERR bit). The ERROR signal of the parallel interface and the ERR LED of the indicator light are not cleared.

Signal	Name	Function
XEXE	Flow Command Request Bit	This is turned ON when a command will be performed while PLC Link, Fieldbus, or parallel flow control is performed.
Flow Command Request		
DI (DI0 to DI7)	Command Input Signals	These are used to input commands from a parallel interface.
ENCTRIG	Encoder Trigger Input (Phase A, B, Z)	This is the encoder input signal. This signal is only available when the encoder trigger will be used.

● Output Signals (Sensor Controller to External Device (PLC, etc.))

Signal	Name	Function
BUSY	Busy Signal	This signal indicates that new requests cannot be accepted because an external input such as a command is currently handled. “ON” of this signal does not mean that a command is currently performed. To check whether a command is being executed, check the Command Completion (FLG) signal.
FLG	Control Command Completion Signal	The Sensor Controller uses this signal to inform the user (PLC) that a command has been completed.
Command Completion		
GATE	Data Output Completion Signal	This signal informs the user (PLC) of the timing to load output data. “ON” of this signal indicates that the Sensor Controller is outputting the data.*1
Result Notification		
READY	Camera Image Input Enabled Signal	This signal indicates that the STEP (Measurement Trigger) signal or the Trigger signal can be input.*2 When the multi-input function is used, following STEP signal or Trigger signal is accepted only when this signal is “ON”.
Trigger Ready		
OR	Overall Judgment Output Signal	This signal notifies the overall judgment results.*3
Total Judgment		
DO (DO0 to DO15)	Data Output Signals	These signals are used to output parallel data and parallel judgment through a parallel interface.*3
XFLG	Flow Command Completion Bit	This signal indicates that a command performed while PLC Link or Fieldbus flow control is being performed has been completed.
Flow Command Completion		
XBUSY	Measurement Command Busy Bit	This signal indicates that a command input while PLC Link or Fieldbus flow control is being performed is in execution.
Flow Command Busy		
XWAIT	Measurement Command Wait Bit	This signal indicates that a command input can be accepted while PLC Link or Fieldbus flow control is being performed.
Flow Command Wait		
Trigger ACK	Trigger Signal Acknowledged Bit	This signal indicates that the Sensor Controller has accepted a Trigger signal.
Command Ready	Command Execution Ready Bit	This signal indicates that a control command is executable.

Signal	Name	Function
ERR	Error Signal	<p>This signal indicates that the Sensor Controller detects the following errors.</p> <ul style="list-style-type: none"> • Camera connection error • Battery error • Fan error • System error • Communications timeout • STEP input during measurement <p>The ERR signal does not turn OFF even after the error is eliminated. The signal turns OFF only when the error status is cleared by a control command.</p> <p>For details, refer to <i>Error Messages and Troubleshooting</i> in the <i>Vision System FH/FHV Series User's Manual (Cat. No. Z365)</i>.</p>
Error Status		
RUN	Measurement Mode Signal	<p>This is a notification signal indicating the Sensor Controller is in Run mode (In a measurement capable state with <i>RUN signal output</i> checked in the Layout settings for the currently displayed line).</p>
Run Mode		
ACK	Command Completion Flag	This signal indicates that the DI command execution has been completed.
SHTOUT	Exposure Completion Signal	This signal indicates that Camera exposure has been completed.
STGOUT	Strobe Trigger Output	This is the trigger signal for the strobe.

- *1. This signal is linked to the Output Unit processing items in the measurement flow. This has no linkage relation with the BUSY signal. Also, this has no linkage relation with the OR signal in the parallel communication protocol. Note that the operation is different when PLC Link is used. For details, refer to *2-2 Communicating by PLC Link* on page 2-128.
- *2. This signal is always OFF during display of a through image. When you use a camera with lighting controller, based on its type and connecting conditions, the time required for the READY or Trigger Ready signal to turn OFF may increase in comparison with not using it. For details, refer to *Camera Image Input FH*, *Camera Image Input HDR*, or *Camera Image Input FHV* in the *Vision System FH/FHV Series User's Manual (Cat. No. Z365)*.
- *3. Output only when the *Output* option is selected.

1-4-2 Command/Response Method

• Parallel

Commands are input to the Sensor Controller by turning the DI signals (DI0 through DI7) ON and OFF. Since there is no direct response for these commands, so check the ACK signal whether or not a command was accepted.

The command code is input with signals DI0 through DI6, and the command is performed by turning DI7 ON.

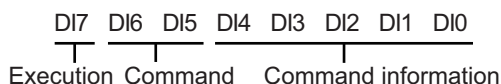

• PLC Link, EtherNet/IP, EtherCAT, or PROFINET

By storing control commands from the PLC to the Sensor Controller and responses from the Sensor Controller to the PLC into the PLC's I/O memory, command and response control signals are exchanged. This enables you to control the Sensor Controller using commands such as single measurement and scene switch without any sequence control such as issuing communication commands from the PLC.

Memory Areas Used by the Command/Response Method

Command Area	You write the control commands to execute for the Sensor Controller to this area.
Response Areas	You read the performed results of the control commands written in the Command Area from this area.

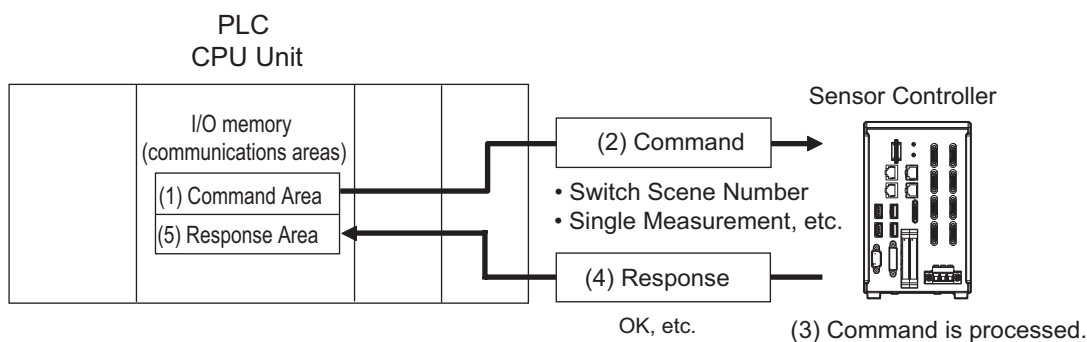

Flow of Communications between the PLC and the Sensor Controller

- (1) The PLC (the user) writes a control command to a specified PLC's I/O memory area (the Command Area).
- (2) The PLC (the user) then turns the EXE bit ON to send the control command to the Sensor Controller.
- (3) The Sensor Controller performs the received control command.
- (4) The Sensor Controller returns a response to the PLC after the control command was performed.
- (5) The PLC (the user) stores the response in a specified PLC's I/O memory area (the Response Area).

The communication commands depend on the communication protocol used.

For details, refer to *A-1-3 Command List* on page A-7.



Additional Information

Command-driven character string output is not supported when using EtherNet/IP tag data link communication, EtherCAT, or PROFINET.

To output character strings, use commands equivalent to Non-procedure communication in the EtherNet/IP message communication.

For details, refer to 2-3-19 *Communicating with the Sensor Controller using EtherNet/IP Message Communications* on page 2-253

• Non-procedure Communications

Communication commands are sent to the Sensor Controller through sequence control in the PLC. An external device and the Sensor Controller communicate through non-procedure (normal) communications.

1-4-3 Data Output after Measurements

Just after a Single Measurement or Start Continuous Measurement command is executed, the Sensor Controller automatically outputs the data associated with the measurement specified in advance as output items to the PLC. This allows you to easily pass measurement results data from the processing items to the PLC. You can also choose to output only when the PLC meets the conditions required to receive the data (i.e., when handshaking is enabled).

The output destination for data depends on the protocol that is used to communicate between the external device and the Sensor Controller, as described below.

• PLC Link, EtherNet/IP, EtherCAT, or PROFINET

The output data is automatically output to the PLC's specified I/O memory below.

Area of Memory Used for Data Output after Measurements:

Data output area	After measurement performed, the output data associated with the measurement is written to this area by the Sensor Controller.
-------------------------	--

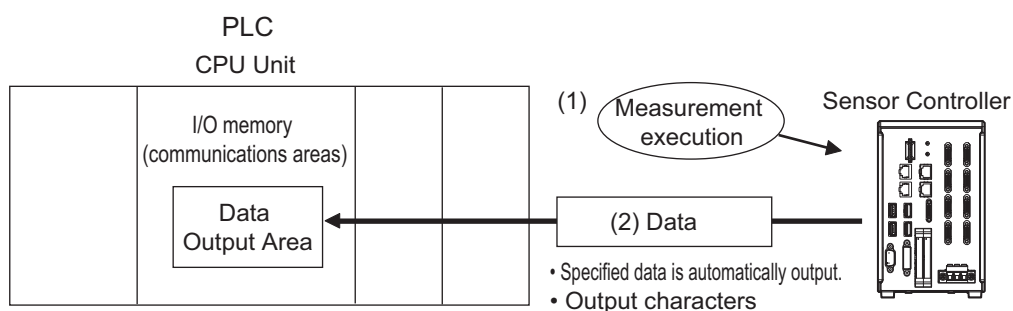

Flow of Communications between the PLC and the Sensor Controller:

The data to output after measurement performed and the PLC I/O memory area (Data Output Area) to store that data need to be specified in advance. For details, refer to *Settings Required for Data Output* on page 1-20.

- (1) Measurement is performed.
- (2) After the measurement was performed, the specified measurement data is stored in the Data Output Area in the PLC.

- **Parallel**

The data is output to the PLC signal lines via DO signals (DO0 to DO15).

- **Non-procedure Communications**

The data is output to the PLC reception buffer through non-procedure (normal) communications.

Outputting the Measurement Data

The measurement data is output to the external device via the Communications Module by the processing unit for data output (hereafter, Output Unit) placed in the measurement flow.

Therefore, to output measurement data, you must place an Output Unit in the measurement flow in advance.

The measurement data is output when the Output Unit is performed and not when the measurement has been completed.

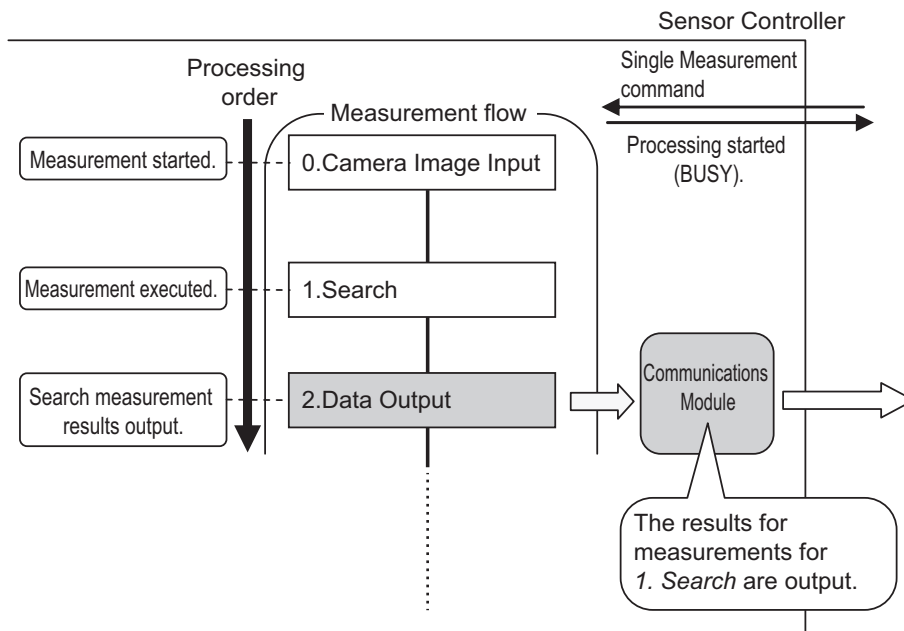

You can output character strings read by processing items such as Character Inspection, Barcode, or 2D Code. (Available only for PLC Link and Non-procedure protocols)

Character strings are output simultaneously when the processing item is performed.

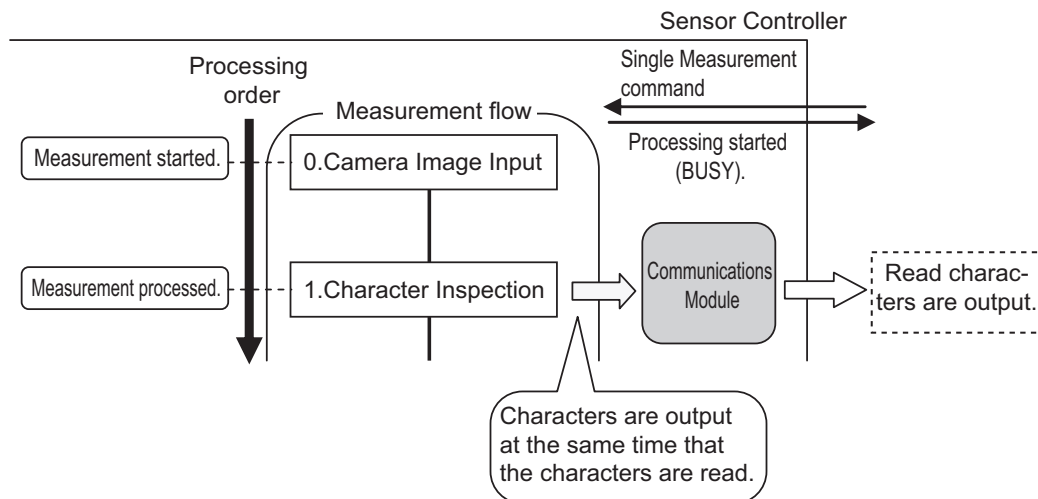

Additional Information

Command-driven character string output is not supported when using EtherNet/IP tag data link communication, EtherCAT, or PROFINET.

To output character strings, use commands equivalent to Non-procedure communication in the EtherNet/IP message communication.

For details, refer to *2-3-19 Communicating with the Sensor Controller using EtherNet/IP Message Communications* on page 2-253

Items that can be Output as Output Data

• Measurement Data

You can output at once up to eight items (32 bytes) with performing one Output Unit.



Additional Information

- If you need to output nine or more data items, set more than one Output Unit processing unit in the measurement flow.
For details, refer to *Outputting Multiple Measurement Data Items* on page 1-21
- The number of data items that can be output by one Output Unit can be increased by changing a setting when using PLC Link or EtherCAT communications, as shown below.
 - PLC Link: 256 max. (1,024 bytes max.)
 - EtherCAT: 64 max. (256 bytes max.)

The following items can be output.

- Judgment result
- Measured parameters (correlation values, reference coordinates, etc.)
- Results calculated based on the values of the measured parameters
- Judgment results for expression results (Parallel Judgment Output)

• Character Output (Available only for PLC Link and Non-procedure Protocols)

You can output character strings read by processing items such as Character Inspection.

The maximum number of output characters are as follows.

- Character Inspection: 32 characters
- Barcode: 1,024 characters
- 2DCode: 652 characters

- 2DCode II: 652 characters
 - OCR: 128 characters (32 characters x 4 lines)
- NULL (\0) is attached at the end of the read string to be output.

The processing items supporting character strings output are listed below.

- Character Inspection
- Barcode
- 2DCode
- 2DCode II
- OCR

For details of the character output format, refer to each processing item description in the *Vision System FH/FHV Series Processing Items Reference Manual (Cat. No. Z341)*.



Additional Information

Command-driven character string output is not supported when using EtherNet/IP tag data link communication, EtherCAT, or PROFINET.

To output character strings, use commands equivalent to Non-procedure communication in the EtherNet/IP message communication.

For details, refer to *2-3-19 Communicating with the Sensor Controller using EtherNet/IP Message Communications* on page 2-253

Settings Required for Data Output

Use the following procedures to set up Output Unit for data output.

• Measurement Data

1. Place the data output processing unit(s) in the processing flow.

Place the processing unit for data output in the measurement flow.

Processing Units That Serve as Output Units:

On the processing item tree in the Flow Editor window, the processing items under *Output result* serve as Output Units.

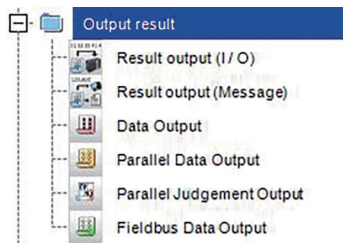

Output Unit Selection:

Select the Output Units with the following combination according to a communication protocol to be used.

For details of communication protocols, refer to *1-3-4 Communication Protocols for Communicating with the Sensor Controller* on page 1-9.

OK: Data can be output, - : Data cannot be output.

Output unit	Communication Protocol					
	Parallel	PLC Link	EtherNet/IP	EtherCAT	PROFINET	Non-procedure
Result Output (I/O)	-	OK	OK*1	OK	OK	-
Result Output (Message)	-	-	-	-	-	OK
Result Output (Parallel I/O)	OK	-	-	-	-	-
Parallel Data Output	OK	-	-	-	-	-
Parallel Judgment Output	OK	-	-	-	-	-
Serial Data Output	-	OK	-	-	-	OK
Fieldbus Data Output	-	-	OK	OK	OK	-

*1. Except message communications



Precautions for Correct Use

When Non-procedure UDP is used to output data of *Result output (Message)*, the Sensor Controller outputs the data to only the device whose command was accepted in the end.

2. Set the items to output

Set the items to output as output data in the Output Units placed in the measurement flow.

For the procedures to set output items in the Output Units, refer to the description for each communication protocol.

• Character Output (Available only for PLC Link and Non-procedure Protocols)

Perform the character output settings for processing items to read output characters such as Character Inspection.

Since the above processing items perform the character output operation, it does not need to set Output Units in the measurement flow. For the settings to output characters, refer to the description for each processing item in the *Vision System FH/FHV Series Processing Items Reference Manual (Cat. No. Z341)*.

- Character Inspection
- Barcode
- 2DCode
- 2DCode II
- OCR



Additional Information

Command-driven character string output is not supported when using EtherNet/IP tag data link communication, EtherCAT, or PROFINET.

To output character strings, use commands equivalent to Non-procedure communication in the EtherNet/IP message communication.

For details, refer to *2-3-19 Communicating with the Sensor Controller using EtherNet/IP Message Communications* on page 2-253

Outputting Multiple Measurement Data Items

- Using Multiple Output Units for Data Output

You can register more than one Output Unit in the measurement flow.

If you want to output different types of data during measurement flow processing, or if you want to output more than nine different data items, you must register multiple Output Units in the measurement flow.

Although data output is performed for each Output Unit placed in the measurement flow, the output destination for the data is the same PLC's I/O memory area (Data Output Area).

Therefore, the first output data is overwritten by the following output data if you do nothing. When you want to save all the output data, take one of the following means.

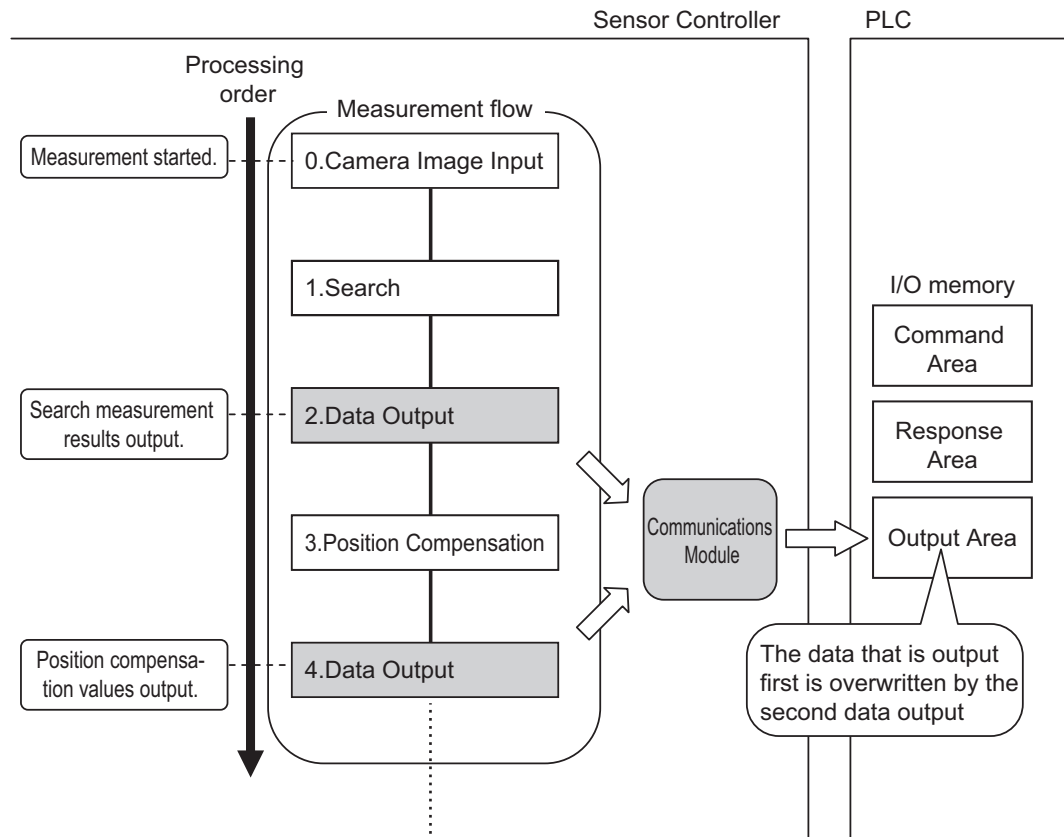

- **Outputting Data with Result Output (I/O) or Result Output (Message) Processing Unit**

The “Result Output (I/O)” or “Result Output (Message)” processing item can output nine or more items by only one processing item.

For details, refer to *Result Output (I/O)* or *Result Output (Message)* in the *Vision System FH/FHV Series Processing Items Reference Manual (Cat. No. Z341)*.

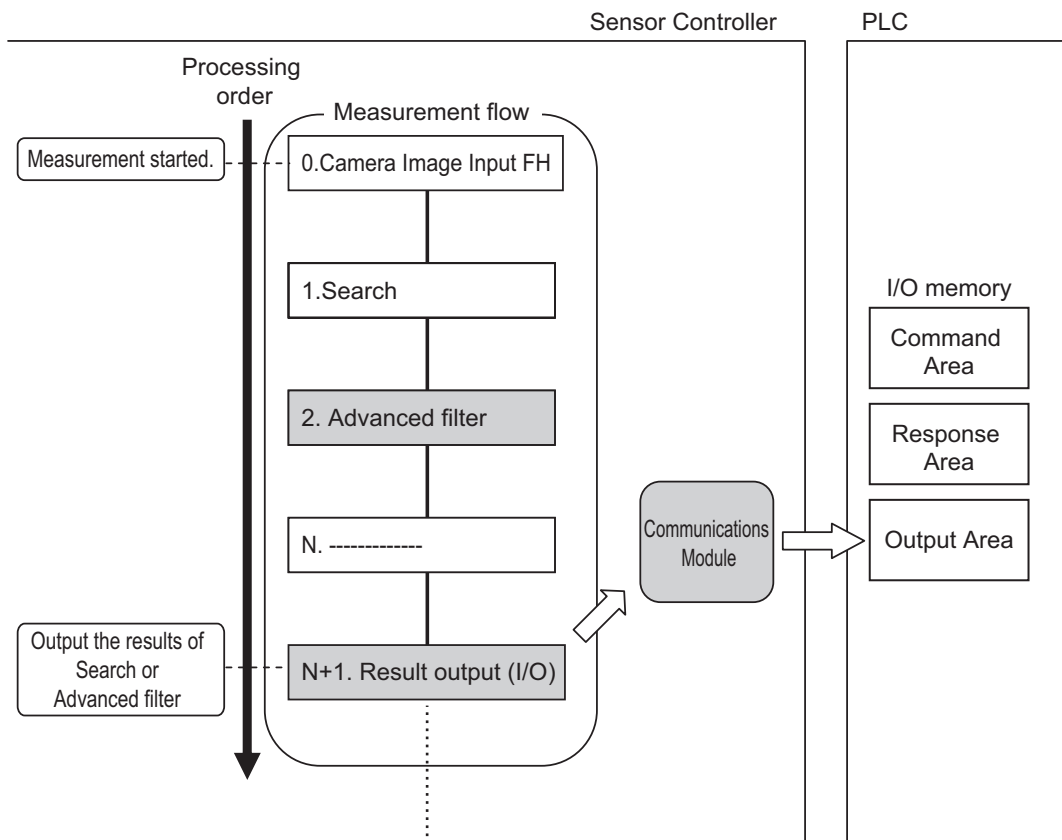

Offsets (Available only for PLC Link Communication Protocol):

When you use multiple Output Units to output data, you can offset the write destination of the output data for each Output Unit.

Set the *Offset* for the Data Output. For details, refer to 2-2-5 Output Data Settings (Processing Item Registration) on page 2-155.

Controlling Data Output with Handshaking:

When handshaking is used to control data output, the timing of outputting the data is controlled by I/O signals. Therefore, each time that data is output, read and move the data to a different part in the PLC's I/O memory. For details, refer to Data Output Control with Handshaking on page 1-24.



Additional Information

For ASCII data output through Non-procedure communications, you can append a record separator after each output data item. (The default is the delimiter.)

The following two types of Output Units can be used via parallel communications:

Output unit	Output data
Parallel Data Output	The measurement data is output. Up to eight items can be output.
Parallel Judgment Output	The judgment results are output. Up to 16 judgment results can be output. The following two types of judgment results can be output. <ul style="list-style-type: none"> • Judgment results for specified processing items. • Judgment results of arbitrary judgment conditions set for specified item values

Parallel Data Output and Parallel Judgment Output Units are output in the order they are processed in the measurement flow.

• Outputting Multiple Items with Parallel Data Output

The items set for output data numbers 0 through 7 via parallel data output are output to the PLC's reception buffer in ascending order, one data item at a time (16-bit units). Each time a data item is output, the GATE signal turns ON. ^{*1}

In that time, the first data item output to the PLC's reception buffer (data 0) is overwritten with the following output data item (data 1).

Therefore, the data output to the PLC's reception buffer needs to be moved to the PLC's memory each time the GATE signal turns ON.

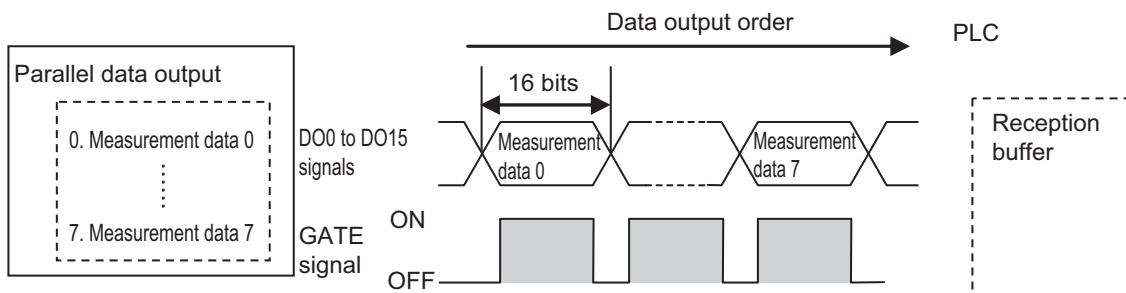

*1: The operation of the DSA signal depends on whether *Handshaking* for output control is enabled. For details, refer to *Data Output Control with Handshaking* on page 1-24.

Data Output Control with Handshaking

The timing for data output can be controlled through the DSA and GATE signals.

As the timing for transferring output data can be controlled, it is useful when output data from multiple Output Units is received.

• Requirements for Using Data Output Control with Handshaking

When controlling data output, set the output control method to *Handshaking* in the communication protocol settings.

For details, refer to *Communications Specifications Setting* for each communication protocol.

Parallel Communications:	2-6-4 <i>Communications Specifications Settings</i> on page 2-362
PLC Link Communications:	2-2-4 <i>Communication Specifications Settings</i> on page 2-133
EtherNet/IP Communications:	2-3-7 <i>Communication Specifications Settings</i> on page 2-201
EtherCAT Communications:	2-1-11 <i>Communication Specifications Settings</i> on page 2-23
PROFINET Communications:	2-4-6 <i>Communication Specifications Settings</i> on page 2-270

• Handshaking

When the external device does not turn ON the DSA signal, the measurement data will not be output to the external device from the Sensor Controller. While the DSA signal is ON, the GATE signal turns ON when the measurement data is output from the Sensor Controller.

The external device takes in the measurement data when the GATE signal turns ON.

Signals Used for Handshaking

Signal	Name	Description
DSA	Data Output Request Signal	This signal is sent by the external device (PLC) to the Sensor Controller to request data output.

Signal	Name	Description
GATE	Data Output Completion Signal	This signal is sent by the Sensor Controller to inform the external device (PLC) of the timing to load output data. This signal is output only when the DSA signal is ON.*1

*1. When handshaking is not enabled for output control, the GATE signal will also be turned ON when data is output from the Sensor Controller. However, when handshaking is disabled for output control during PLC Link communications, the GATE signal is not even output.

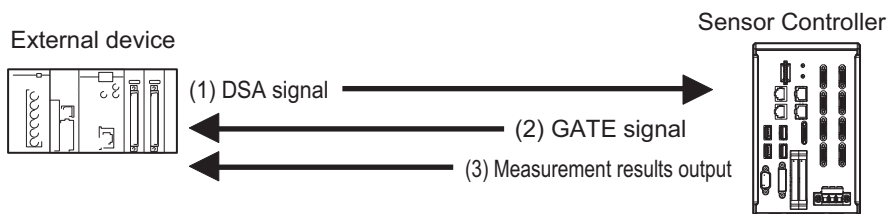

- (1) The PLC turns ON the DSA signal and waits for the output data.
- (2) The Sensor Controller turns ON the GATE signal when the DSA signal is ON and it is ready to output the measurement results.*1
- (3) The Sensor Controller turns ON the GATE signal and outputs the output data.

*1. This is when an Output Unit in the measurement flow is performed.

• **DSA Signal ON Timing**

The DSA signal needs to be turned ON when data is required.

When an Output Unit has been performed and data to output is ready, the Sensor Controller will output the data when it detected the DSA signal turned ON.

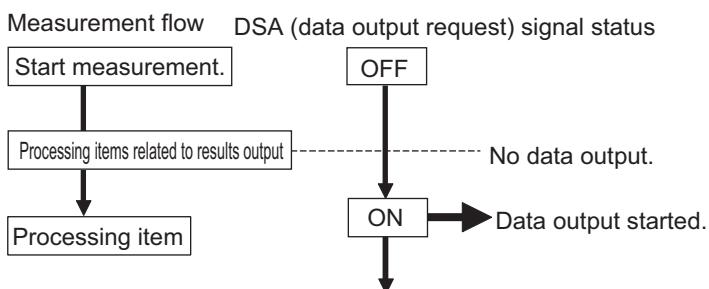

To output measurement results immediately, issue the measurement trigger and turn ON the DSA signal. The Sensor Controller does not check the change from OFF to ON of the DSA signal but checks the ON state. As the measurement results are output from the Sensor Controller to the external device immediately when the Output Unit is performed, the PLC takes in the output data at once.

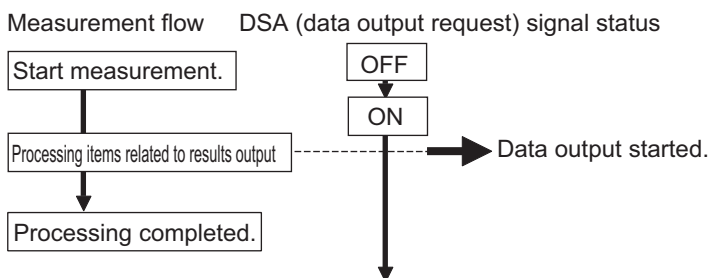

• **Receiving Multiple Continuous Output Data Items**

When multiple output data items from multiple Output Units are received, receive the data one at a time using the DSA and GATE signals.

(i.e., PLC Link Communications with handshaking).

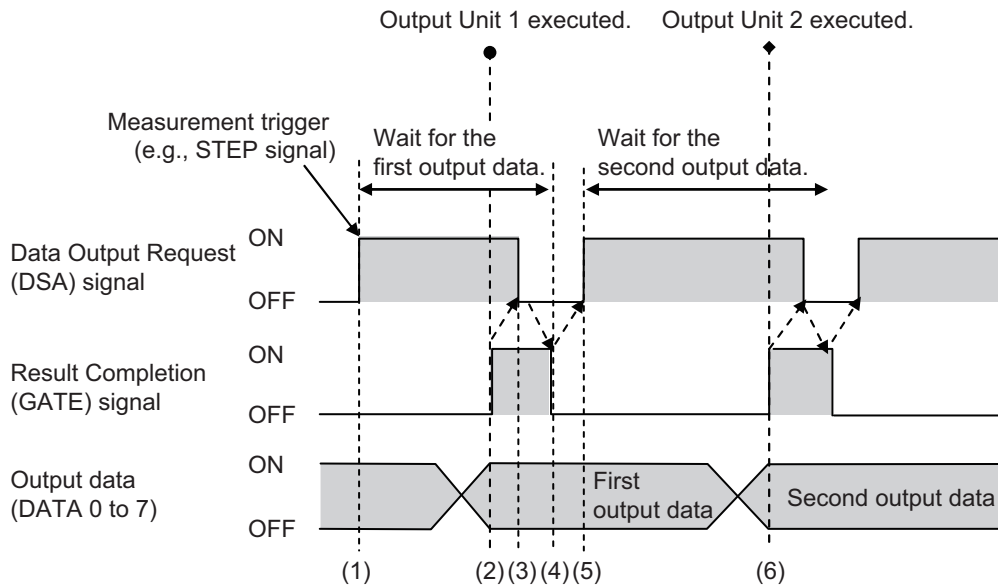

- (1) When the first data is received, the user (PLC) turns ON the measurement trigger and the DSA signal.
- (2) The Sensor Controller turns ON the GATE signal when the DSA signal is ON, and it outputs the first data.
- (3) The user (PLC) turns OFF the DSA signal when the GATE signal turns ON. Then the user (PLC) checks the output data received in the PLC's Data Output Area and moves it to another area in the PLC I/O memory.
- (4) The Sensor Controller checks that the DSA signal is turned OFF and turns OFF the GATE signal automatically.
- (5) The user (PLC) turns ON the DSA signal again after receiving the output data has completed and the GATE signal is turned OFF, and waits for the second data.
- (6) When the second data is output, the second data output is received when the GATE signal is turned ON and step 3 to 5 are repeated.

Step 3 to 5 above are repeated for all subsequent data output items.

1-5 Setting Procedures for Communications

This section describes an overview of the setting procedures that the Sensor Controller starts communication with an external device such as a PLC, and the communication modules to be used for the communications.



Additional Information

For connection with a Touch Panel Monitor, refer to *Settings for Touch Panel Monitor* in the *Vision System FH/FHV Series User's Manual (Cat. No. Z365)*.

1-5-1 Communications Setup Procedures

To communicate with an external device, the settings below are configured.

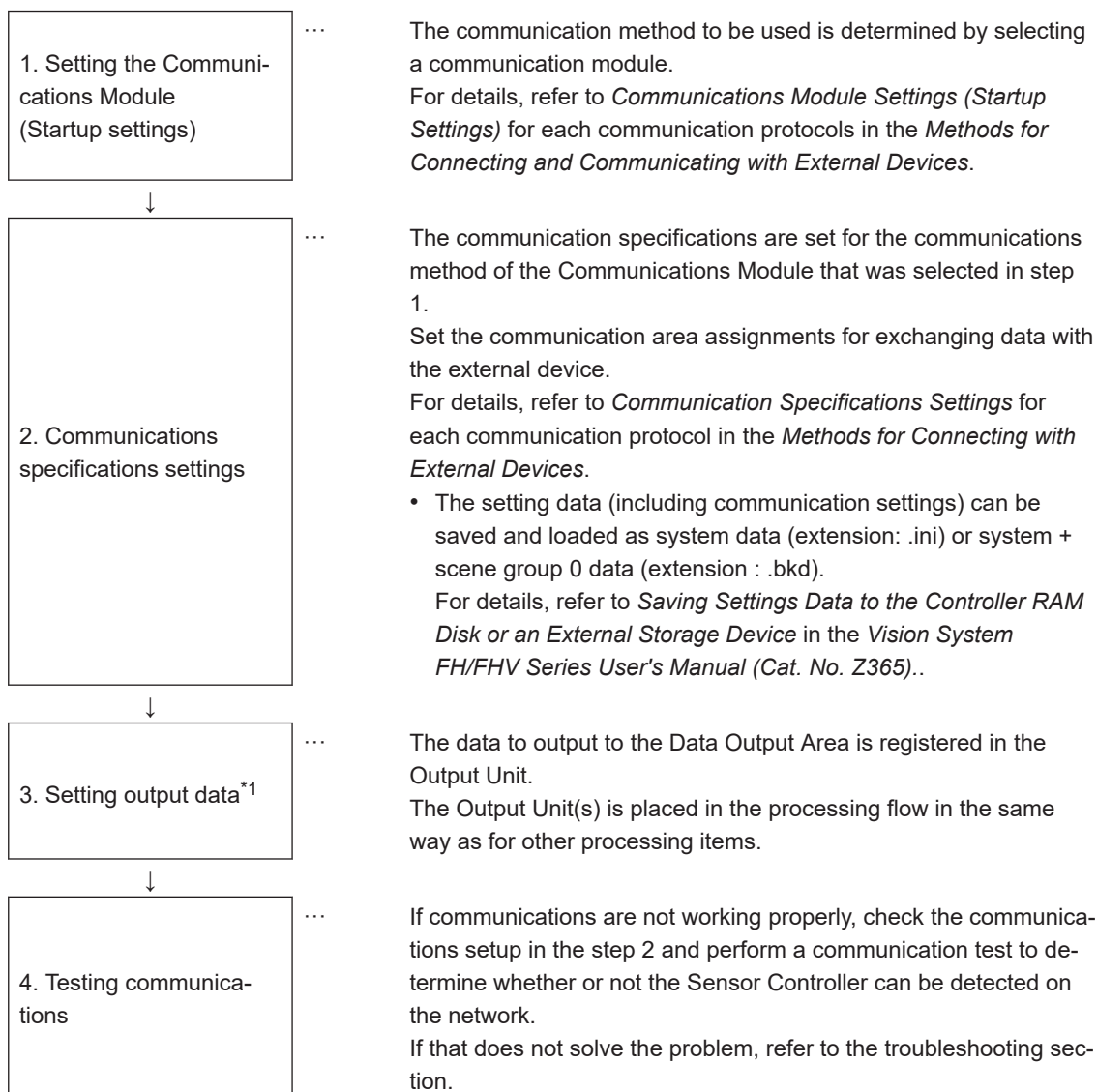

*1. When performing control through data sharing (data output after measurement).

1-5-2 Communications Protocols and Communications Modules

A Communications Module is used to communicate between the Sensor Controller and an external device.

The appropriate Communications Module needs to be previously set for the communication protocol to be used to communicate between the Sensor Controller and the external device.

● Communications Module Settings

The Communication Module used for communications is selected in the startup settings.

- 1** On the Main window, click **Tool - System Settings** to open the system settings.
- 2** On the Multiview Explorer on the left, select **System settings - Startup - Startup setting** and then click the **Communication** tab.
For details of setting procedures, refer to *Communications Module Settings* for each communications protocol.



Precautions for Correct Use

After you select the Communications Module to use, save the settings to the Sensor Controller and restart the Sensor Controller.

The selected Communications Module will be enabled after the Sensor Controller restarts. You can then set up the communications.

● Selecting a Communications Module

Select one of the following Communication Modules based on a combination of the communication protocol used to connect between the Sensor Controller and an external device, and the communication interface.

Communications protocol	Communication interface	Communication Module
Parallel	Parallel	Standard Parallel I/O
PLC Link	Ethernet	Serial (Ethernet) <ul style="list-style-type: none"> • PLC Link (SYSMAC CS/CJ/CP/One) (UDP) • PLC Link (SYSMAC CS/CJ/CP/One) (TCP) • PLC Link (MELSEC QnU/QnAS) (UDP) • PLC Link (MELSEC QnU/QnAS) (TCP) • PLC Link (JEPMC MP)
	RS-232C	Serial - PLC Link (RS-232C) <ul style="list-style-type: none"> • PLC Link (SYSMAC CS/CJ/CP/One) • PLC Link (MELSEC QnU/Q/QnAS)
EtherNet/IP	EtherNet/IP	Fieldbus <ul style="list-style-type: none"> • EtherNet/IP • EtherCAT • PROFINET

Communications protocol	Communication interface	Communication Module
Non-procedure	Ethernet	Serial (Ethernet) <ul style="list-style-type: none"> • Non-procedure (UDP) • Non-procedure (TCP) • Non-procedure (TCP Client) • Non-procedure (UDP) (Fxxx series method)
	RS-232C	Serial (RS-232C) <ul style="list-style-type: none"> • Non-procedure • Non-procedure (Fxxx series method)

1-6 Differences in Specifications Based on the Communications Protocol

This section describes the types and differences of communication protocols that are used for communications with the Sensor Controller.

1-6-1 List of Supported Signals by Communications Protocol

Some of the control and status signals to be used depend on the communication protocol as shown below.

The table below can be used to check which *signals exist in each communication protocol* by means of a vertical arrangement.

Note that this table does not indicate whether signals of one communication protocol can be used simultaneously with signals of other communication protocols.

For restriction on communication protocols that can be used simultaneously, refer to *1-6-2 Restrictions when Using Different Communication Protocols Simultaneously* on page 1-32.



Precautions for Correct Use

The control signals and status signals cannot be used for control in Non-procedure communications.

● Input Signals (External Device (PLC, etc.) to Sensor Controller)

OK: Can be used, - : Cannot be used

Signal	Name	Signals for each communication protocol				
		Parallel	PLC Link	EtherNet/IP	EtherCAT	PROFINET
EXE	Control Command	-	OK	OK	-	OK
Command Request	Execution Signal	-	-	-	OK	-
Trigger	Measure Bit	-	-	-	OK	-
STEP	Measure Bit	OK	-	OK	-	OK
DSA (Used only for handshaking output control)	Data Output Request Signal	OK	OK	OK	-	OK
Result Set Request		-	-	-	OK	-
ERCLR	Error Clear Bit	-	-	OK	-	-
Error Clear		-	-	-	OK	-
XEXE	Flow Command Request Bit	-	OK	OK	-	OK
Flow Command Request		-	-	-	OK	-
DI (DI0 to DI7)	Command Input Signals	OK	-	-	-	-
ENCTRIG	Encoder Trigger Input (Phase A, B, Z)	OK	-	-	-	-

● Output Signals (Sensor Controller to External Device (PLC, etc.))

OK: Can be used, - : Cannot be used

Signal	Name	Signals for each communication protocol				
		Parallel	PLC Link	EtherNet/IP	EtherCAT	PROFINET
BUSY	Busy Signal	OK ^{*1}	OK ^{*1}	OK ^{*1}	OK ^{*1}	OK ^{*1}
FLG	Control Command Completion Signal	-	OK	OK	-	OK
Command Completion		-	-	-	OK	-
GATE	Data Output Completion Signal	OK	OK ^{*2}	OK	-	OK
Result Notification		-	-	-	OK	-
READY	Camera Image Input Enabled Signal	OK	-	-	-	-
Trigger Ready		-	-	-	OK	-
OR	Overall Judgment Output Signal	OK	- ^{*3}	OK	-	OK
Total Judgment		-	-	-	OK	-
One-shot OR ^{*4}	One-shot Overall Judgment Result Signal	OK	-	-	-	-
DI (DO0 to DO15)	Data Output Signals	OK	-	-	-	-
XFLG	Flow Command Completion Bit	-	OK	OK	-	OK
Flow Command Completion		-	-	-	OK	-
XBUSY	Measurement Command Busy Bit	-	OK	OK	-	OK
Flow Command Busy		-	-	-	OK	-
XWAIT	Measurement Command Wait Bit	-	OK	OK	-	OK
Flow Command Wait		-	-	-	OK	-
Trigger ACK	Trigger Signal Acknowledged Bit	-	-	-	OK	-
Command Ready	Command Execution Ready Bit	-	-	-	OK	-
ERR	Error Signal	OK	-	OK	-	OK
Error Status		-	-	-	OK	-
Run	Measurement Mode Signal	OK	-	OK	-	OK
Run Mode		-	-	-	OK	-
ACK	Command Completion Flag	OK	-	-	-	-
SHTOUT	Exposure Completion Signal	OK	-	-	OK	-
STGOUT	Strobe Trigger Output	OK	-	-	-	-

*1. This will not be detected while commands received through any other protocol are processed. The BUSY signal in Parallel can be shared in all protocols. If you use more than one protocol and need to detect command execution, use the BUSY signal in Parallel.

*2. Data is not output when there is no handshaking used in PLC Link.

*3. The OR signal is unavailable in PLC Link.

*4. The one-shot OR signal is only available in Parallel.

1-6-2 Restrictions when Using Different Communication Protocols Simultaneously

The Sensor Controller series can use different communication protocols together. Restrictions in combined use are as follows:

- The Parallel Communication Module can be used with any other Communication Modules.
- Communication Modules other than the Parallel ones have the following restrictions in the combination.

PLC Link for Vision Systems is unavailable simultaneously with Ethernet and RS-232C.

PLC Link for Vision Systems is unavailable simultaneously with EtherNet/IP, EtherCAT, and PROFINET.

PROFINET is unavailable simultaneously with other non-procedure protocol using Ethernet.

All combinations of Communication Modules other than above are available.



Precautions for Correct Use

If control signals or commands are input simultaneously to the Sensor Controller from different Communications Modules, they may not be received correctly. Check the status signals for each Communications Module and input control signals and commands at different times for each.

1-6-3 Restrictions in Communication Protocols by Operation Mode

The Sensor Controller can select its operating mode. The following describes typical restrictions for each operating mode.

For details, refer to *Setting Operation Mode* in the *Vision System FH/FHV Series User's Manual (Cat. No. Z365)*.

- **Double Speed Multi-input Mode**
 - To use the Multi-input function, use Parallel or EtherCAT in which the state of the READY signal can be checked. For EtherCAT, check the Trigger Ready signal instead of the READY signal.
 - While the Multi-input function is used, most of the CPU's loads are assigned to measurement processing. Therefore, its performance might drop (response may be delayed or packets lost) or communications errors might occur. While the Multi-input function is used, do not use EtherNet/IP or PROFINET communication protocols.
 - If triggers are continuously inputted with speed that communication outputs will not be in time, it may cause STEP not to be output or measurements to be delayed. Be sure to input triggers with the timing at which communications delay will not occur.
- **Multi-line Random-trigger Mode**
 - Only Line 0 is available in Non-procedure or PLC Link.
 - Depending on communication protocols, each line needs to be set.
 - For Parallel communications, the I/O function and terminals vary depending on the number of lines. This function is not supported by FHV series.
- **Non-stop Adjustment Mode**
 - Communication commands accepted during non-stop data transfer are only the Measurement command (in Parallel, Non-procedure, and PLC Link) and Continuous Measurement command (only Parallel).

1-6-4 Models being Compatible with Communication Protocol

This section describes external devices which can communicate with the Sensor Controller series based on communication protocols.

● PLC Link and NGn-procedure Communications

• Ethernet

OMRON

OK: Can connect, Cond.: Only some models can connect, NG: Cannot connect

Series	CPU unit	Interface	
		Direct connection with CPU unit (Built-in port)	Connection via Ethernet unit
SYSMAC_CJ2	CJ2H or CJ2M	Cond. (Built-in port only)	CJ1W-EIP21 (PLC Link only) or CJ1W-ETN21
SYSMAC_CJ1	CJ1H or CJ1G	NG	CJ1W-EIP21 (PLC Link only) or CJ1W-ETN21
	CJ1M	Cond. (Built-in port only)	CJ1W-EIP21 (PLC Link only) or CJ1W-ETN21
SYSMAC_CS	CS1H, CS1D or CS1G	NG	CJ1W-EIP21 (PLC Link only) or CJ1W-ETN21
SYSMAC_CP1	CP1L	Cond. (Built-in port only)	-
	CP1H	NG	CJ1W-EIP21 (PLC Link only) or CJ1W-ETN21
SYSMAC_One	NSJ	NG	NSJW-ETN21

Mitsubishi Electric

OK: Can connect, Cond.: Only some models can connect, NG: Cannot connect

Series	Model name	CPU unit	CPU unit	Interface	
				Direct connection with CPU unit (Built-in port)	Ethernet Connection via Ethernet unit
MELSEC-QnU	Universal models	QnUDECPU	Q03UDECPU, Q04UDEHCPU, Q06UDEHCPU, Q10UDEHCPU, Q13UDEHCPU, Q20UDEHCPU, Q26UDEHCPU	OK	QJ71E71-100 QJ71E71-B2 QJ71E71-B5
		QnUDCPU	Q03UDCPU, Q04UDHCPU, Q06UDHCPU, Q10UDHCPU, Q13UDHCPU, Q20UDHCPU, Q26UDHCPU	NG	
		QnUCPU	Q00UJCPU, Q00UCPU, Q01UCPU, Q02UCPU	NG	
	Basic models	QnCPU	Q00JCPU, Q00CPU, Q01CPU	NG	
MELSEC-Q Series	High-performance models	QCPU	Q02CPU, Q02HCPU, Q06HCPU, Q12HCPU, Q25HCPU	NG	
MELSEC-QnAS Series	-	-	Q2ASCPU, Q2ASCPU-S1, Q2ASHCPU, Q2ASHCPU-S1	NG	

• **RS-232C**

OMRON

OK: Can connect, Cond.: Only some models can connect, NG: Cannot connect

Series	CPU unit	Interface	
		Direct connection with CPU unit (Built-in port)	Connection via serial communication unit
SYSMAC_CJ2	CJ2H	OK	CJ1W-SCU21-V1, CJ1W-SCU31-V1, CJ1W-SCU41-V1, CJ1W-SCU22, CJ1W-SCU32, CJ1W-SCU42
	CJ2M	Cond. (Built-in port only)	CJ1W-SCU21-V1, CJ1W-SCU31-V1, CJ1W-SCU41-V1, CJ1W-SCU22, CJ1W-SCU32, CJ1W-SCU42
SYSMAC_CJ1	CJ1H, CJ1G, or CJ1M	OK	CJ1W-SCU21-V1, CJ1W-SCU31-V1, CJ1W-SCU41-V1, CJ1W-SCU22, CJ1W-SCU32, CJ1W-SCU42

Series	CPU unit	Interface	
		Direct connection with CPU unit (Built-in port)	Connection via serial communication unit
SYSMAC_CS	CS1H, CS1D, or CS1G	OK	CS1W-SCB□□-V1 CS1W-SCU21-V1 CS1W-SCU31-V1
SYSMAC_CP1	CP1E, CP1L, or CP1H	Cond. (Built-in port only)	CP1W-CIF01
SYSMAC_One	NSJ	OK	-
SYSMAC NJ	NJ501 or NJ301	NG	CJ1W-SCU22 CJ1W-SCU32 CJ1W-SCU42

Mitsubishi Electric

OK: Can connect, Cond.: Only some models can connect, NG: Cannot connect

Series	Model name	CPU unit	CPU unit	Interface	
				Direct connection with CPU unit (Built-in port)	Connection via serial communication unit
MELSEC-QnU	Universal models	QnUDECPU	Q03UDECPU, Q04UDEHCPU, Q06UDEHCPU, Q10UDEHCPU, Q13UDEHCPU, Q20UDEHCPU, or Q26UDEHCPU	NG	QJ71C24N or QJ71C24N-R2
		QnUDCPU	Q03UDCPU, Q04UDHCPU, Q06UDHCPU, Q10UDHCPU, Q13UDHCPU, Q20UDHCPU, or Q26UDHCPU	OK	
		QnUCPU	Q00UJCPU, Q00UCPU, Q01UCPU, or Q02UCPU	OK	
	Basic models	QnCPU	Q00JCPU, Q00CPU, or Q01CPU	OK	
MELSEC-Q Series	High-performance models	QCPU	Q02CPU, Q02HCPU, Q06HCPU, Q12HCPU, or Q25HCPU	NG	
MELSEC-QnAS Series	-	-	Q2ASCPU, Q2ASCPU-S1, Q2ASHCPU, or Q2ASHCPU-S1	NG	A1SJ71QC24 N1 or A1SJ71QC24 N1-R2

● EtherNet/IP

OK: Can connect, Cond.: Only some models can connect, NG: Cannot connect

Series	CPU unit	Interface	
		Direct connection with CPU unit (Built-in port)	Connection via Ethernet unit
SYSMAC NJ	NJ501 or NJ301	OK	CJ1W-EIP21 (Only version 2.1 supports Sysmac NJ connection. This applies to NJ versions 1.01 and later.)
SYSMAC_CJ2	CJ2M or CJ2H	Cond. (Built-in port only)	CJ1W-EIP21
SYSMAC_CJ1	CJ1H or CJ1G	NG	CJ1W-EIP21
	CJ1M	Cond. (Built-in port only)	CJ1W-EIP21
SYSMAC_CS	CS1H, CS1D, or CS1G	NG	CS1W-EIP21

● EtherCAT

OK: Can connect, Cond.: Only some models can connect, NG: Cannot connect

Series	CPU unit	Interface	
		Direct connection with CPU unit (Built-in port)	Connection via master unit
SYSMAC NJ	NJ501 or NJ301	OK	NG

● PROFINET

OK: Can connect, Cond.: Only some models can connect, NG: Cannot connect

Series	CPU unit	Interface	
		Direct connection with CPU unit (Built-in port)	Connection via master unit
SYSMAC NJ	NJ501 or NJ301	NG	CJ1W-PNT21

2

Methods for Connecting and Communicating with External Devices

This section describes the communication specifications, data I/O methods, communication settings, communication commands, and other details for each communication protocol used to communicate between the Sensor Controllers and external devices.

2-1	EtherCAT Connections	2-4
2-1-1	Introduction to EtherCAT	2-4
2-1-2	Structure of CAN Application Protocol over EtherCAT (CoE)	2-7
2-1-3	EtherCAT Slave Information Files (ESI Files)	2-8
2-1-4	Transitions of Communications States	2-9
2-1-5	Process Data Objects (PDOs)	2-10
2-1-6	Service Data Objects (SDOs)	2-13
2-1-7	Communications between Master and Slaves for EtherCAT	2-14
2-1-8	Communication Method of Sensor Controller Connected by EtherCAT	2-15
2-1-9	Communications Settings	2-20
2-1-10	Communications Module Settings (Startup Settings)	2-22
2-1-11	Communication Specifications Settings	2-23
2-1-12	Output Data Settings (Processing Item Registration)	2-28
2-1-13	Setting Output Data (Numerical Values/Character Strings)	2-31
2-1-14	EtherCAT Network Configuration Settings	2-37
2-1-15	Communication Test	2-38
2-1-16	I/O Ports by Area (PDO Mapping) and Memory Allocation	2-39
2-1-17	I/O Signals	2-45
2-1-18	Measurement Results for which Output is Possible (Fieldbus Data Output)	2-50
2-1-19	Command List	2-51
2-1-20	Measurement Trigger Input	2-55
2-1-21	Command Response Processing	2-56
2-1-22	Data Output	2-59
2-1-23	Timing Chart	2-61
2-1-24	EtherCAT Troubleshooting	2-65
2-1-25	Sysmac Error Status	2-67
2-1-26	Sysmac Device Features	2-85
2-1-27	Object Dictionary	2-88
2-2	Communicating by PLC Link	2-128
2-2-1	Communications Processing Flow	2-128
2-2-2	Communications Settings	2-130
2-2-3	Communications Module Settings (Startup Settings)	2-131
2-2-4	Communication Specifications Settings	2-133
2-2-5	Output Data Settings (Processing Item Registration)	2-155
2-2-6	Setting Output Data (Numerical Values and Character Strings)	2-159
2-2-7	Testing Communications	2-165

2-2-8	Memory Allocation	2-170
2-2-9	I/O Signals	2-173
2-2-10	Output Items	2-176
2-2-11	Command List.....	2-177
2-2-12	Command Response Processing	2-181
2-2-13	Data Output	2-184
2-2-14	Timing Chart	2-186
2-2-15	PLC Link Troubleshooting.....	2-189
2-3	Communicating by EtherNet/IP.....	2-192
2-3-1	Introduction to EtherNet/IP	2-192
2-3-2	Data Exchange with EtherNet/IP	2-193
2-3-3	EtherNet/IP Communications	2-196
2-3-4	Communications Processing Flow.....	2-197
2-3-5	Communications Settings	2-199
2-3-6	Communications Module Settings (Startup Settings)	2-200
2-3-7	Communication Specifications Settings.....	2-201
2-3-8	Setting Tag Data Link.....	2-208
2-3-9	Output Data Settings (Processing Item Registration).....	2-213
2-3-10	Setting Output Data (Numerical Values and Character Strings).....	2-217
2-3-11	Testing Communications.....	2-223
2-3-12	Memory Allocation	2-226
2-3-13	I/O Signals	2-235
2-3-14	Output Items	2-239
2-3-15	Command List.....	2-240
2-3-16	Command Response Processing	2-244
2-3-17	Data Output	2-248
2-3-18	Timing Chart	2-250
2-3-19	Communicating with the Sensor Controller using EtherNet/IP Mes- sage Communications.....	2-253
2-3-20	Example for Command Settings	2-256
2-3-21	EtherNet/IP Troubleshooting.....	2-258
2-4	Communicating by PROFINET.....	2-261
2-4-1	Overview of PROFINET	2-261
2-4-2	PROFINET Communications	2-265
2-4-3	Communications Processing Flow.....	2-266
2-4-4	Communications Settings	2-268
2-4-5	Communications Module Settings (Startup Settings)	2-269
2-4-6	Communication Specifications Settings.....	2-270
2-4-7	IO Data Communication Settings	2-277
2-4-8	Output Data Settings (Processing Item Registration).....	2-279
2-4-9	Setting Output Data (Numerical Values and Character Strings).....	2-283
2-4-10	Testing Communications.....	2-289
2-4-11	Memory Allocation	2-292
2-4-12	I/O Signals	2-298
2-4-13	Output Items	2-302
2-4-14	Command List.....	2-303
2-4-15	Command Response Processing	2-306
2-4-16	Data Output	2-309
2-4-17	Timing Chart	2-311
2-4-18	PROFINET Troubleshooting.....	2-314
2-5	Non-procedure Communications	2-317
2-5-1	Communications Processing Flow.....	2-317
2-5-2	Communications Setup Procedures	2-318
2-5-3	Communications Module Settings (Startup Settings)	2-319
2-5-4	Communications Specifications Settings	2-321
2-5-5	Output Data Settings (Processing Item Registration)	2-328
2-5-6	Output Data Settings (Numerical Values/Character Strings)	2-334
2-5-7	Testing Communications.....	2-342
2-5-8	Output Items	2-345
2-5-9	Command Formats	2-347
2-5-10	Command List.....	2-349
2-5-11	Output Format.....	2-353

2-5-12	Non-procedure Communications Troubleshooting	2-355
2-6	Parallel Communications	2-358
2-6-1	Communications Processing Flow	2-358
2-6-2	Communications Setup Procedures	2-360
2-6-3	Communications Module Settings (Startup Settings)	2-361
2-6-4	Communications Specifications Settings	2-362
2-6-5	Output Data Settings (Processing Item Registration)	2-371
2-6-6	Output Data Settings (Numerical value/Judgment)	2-378
2-6-7	Testing Communications.....	2-383
2-6-8	I/O Signals	2-385
2-6-9	Output Items	2-396
2-6-10	Command Formats	2-398
2-6-11	Time Charts	2-403
2-6-12	Parallel Troubleshooting	2-416

2-1 EtherCAT Connections

This section describes the communication settings, communication specifications, input/output formats, and the communication timing chart required for communications by EtherCAT between the Sensor Controller and an external device.

2-1-1 Introduction to EtherCAT

EtherCAT (Ethernet Control Automation Technology) is a high-performance industrial network system that enables faster and more efficient communications based on Ethernet.

Each node achieves a short communication cycle time by transmitting Ethernet frames at high speed. Although EtherCAT is a unique communication protocol, standard Ethernet technology is used for the physical layer, which means you can use Ethernet cables for wider applications.

And the effectiveness of EtherCAT can be fully utilized not only in large control systems that require high processing speeds and system integrity, but also in small and medium control systems

How EtherCAT Works

In EtherCAT communication, Ethernet frames pass through all of the slave nodes.

When a frame passes through a slave node, the slave node reads and writes the data in the area that is allocated to it in the frame in a few nanoseconds.

The Ethernet frames that are transmitted by the EtherCAT master pass through all EtherCAT slaves without stopping. The last slave returns all of the frames, which again pass through all of the slaves before returning to the EtherCAT master.

This mechanism ensures high speed and real-time data transmission.

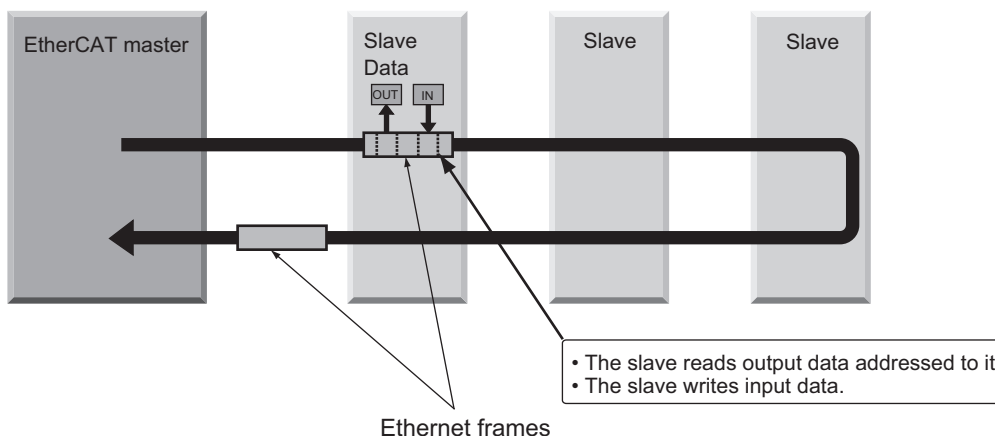

The data exchanges that are cyclically performed between the EtherCAT master and EtherCAT slaves use *EtherCAT datagrams* that are stored directly in the Ethernet frames.

Each *EtherCAT datagram* consists of a header (including the data length and one or more slave addresses), data, and a working counter (i.e., check bits).

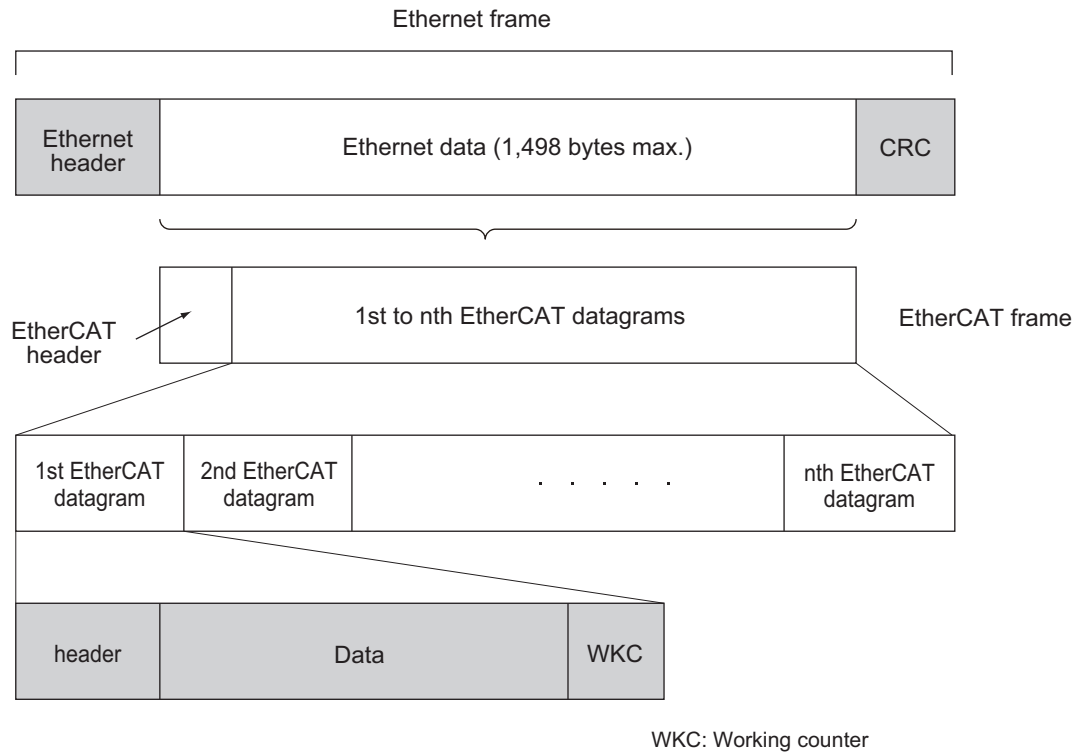

Types of EtherCAT Communications

The following 2 types of communications are available with EtherCAT.

PDO communications are processed in each EtherCAT communication cycle to refresh data continuously. SDO communications are processed between PDO communications.

● Process Data Communications (PDO Communications)

The process data communication function (PDO communications) cyclically transfers process data in real-time.

The EtherCAT master maps the logical process data space to the nodes to achieve cyclic communications between the EtherCAT master and slaves.

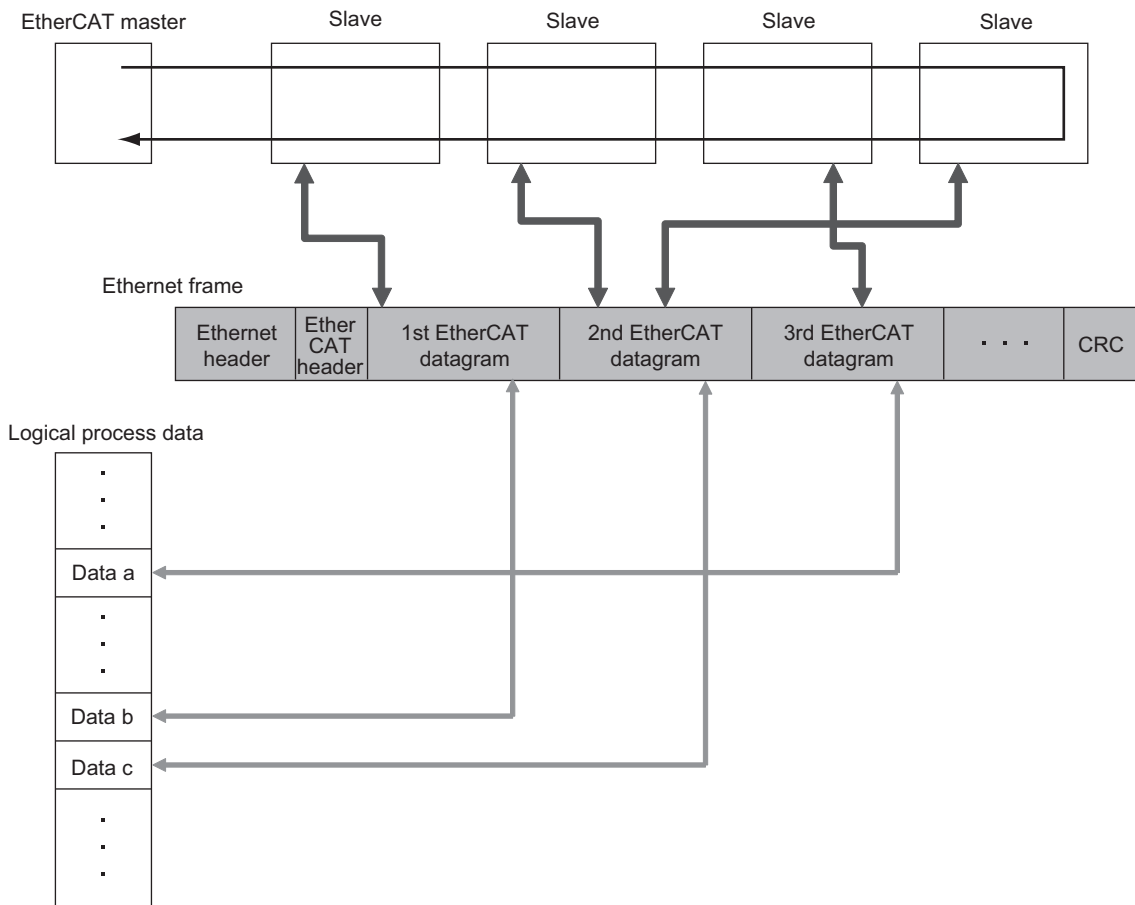

● Mailbox Communications (SDO Communications)

The mailbox communication function (SDO communications) is used to perform message communication.

Whenever necessary, the EtherCAT master sends a command to a slave, and then the slave returns a response to the EtherCAT master.

The mailbox communication function (SDO communication) has the following functions.

- Reading and writing process data
- Setting slaves
- Monitoring slave status

2-1-2 Structure of CAN Application Protocol over EtherCAT (CoE)

EtherCAT allows the use of multiple protocols for communication. EtherCAT slave terminal adopts *CAN application protocol over EtherCAT (CoE)* as a device profile for *CAN application protocol* which is one of the open network standards, which provides the communication interface to apply to EtherCAT devices.

The following figure indicates the CoE structure in the EtherCAT coupler unit.

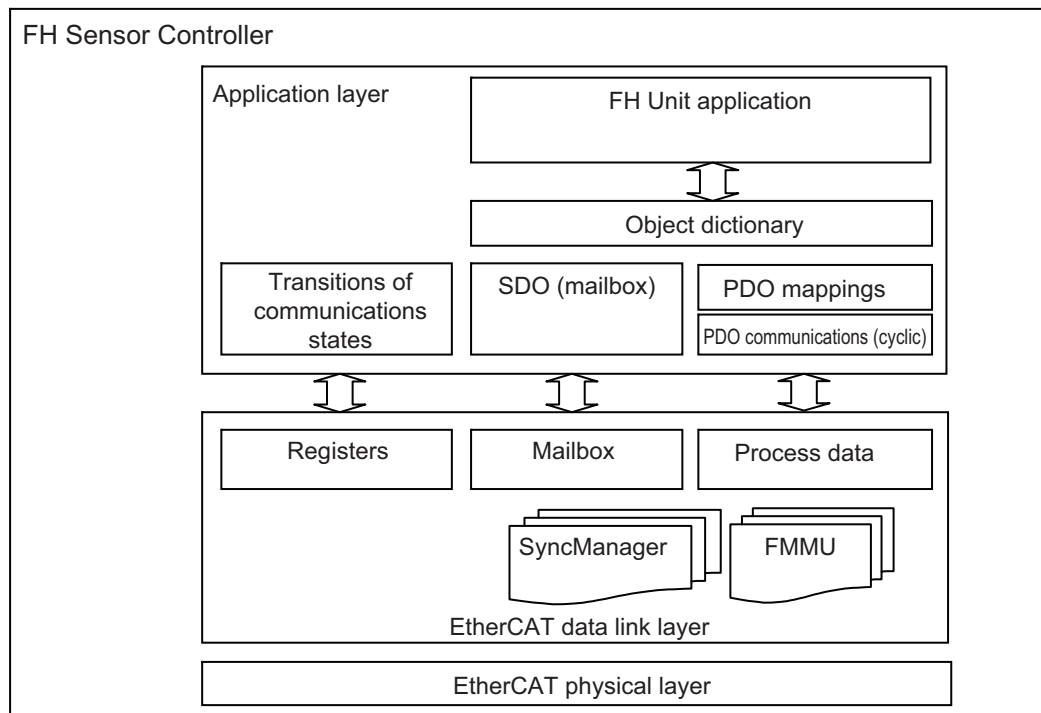

The object dictionary for the CAN application protocol is roughly classified into PDOs (process data objects) and SDOs (service data objects).

PDOs consist of the mappable object dictionaries, and the contents in process data are defined by the PDO mappings. PDOs are used for PDO communications to exchange process data periodically.

Moreover, SDOs can read and write all object dictionaries and are used for non-periodic SDO (event-driven message) communications.

In EtherCAT, by setting the object dictionaries for PDOs and SDOs using the CoE interface, EtherCAT devices that have the same device profiles as the CAN application protocol can be provided.

2-1-3 EtherCAT Slave Information Files (ESI Files)

The setting information for an EtherCAT slave is provided as ESI file (EtherCAT Slave Information). In EtherCAT, its various communication settings are defined based on the ESI definition information and the network connection information for the connected slaves.

Installing ESI files into the network setup software (configuration tool) can generate the network configuration information. (*1)

Downloading the generated network configuration information to the EtherCAT master enables you to setup the EtherCAT network.

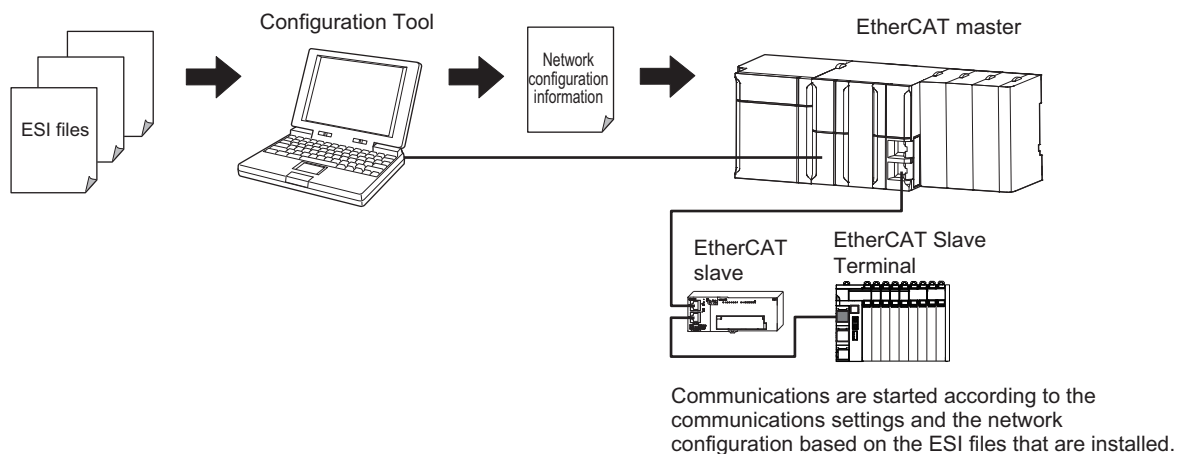

ESI files for the Sensor Controller can be downloaded from the OMRON website.

*1: If you are using Sysmac Studio, it is not necessary to install the ESI files in the network setup software (configuration tool). The ESI files for OMRON EtherCAT slaves have already installed in the Sysmac Studio. Auto-update function in the Sysmac Studio enables you to get the ESI files for the latest models.

2-1-4 Transitions of Communications States

The EtherCAT master controls the state transition model for communication control of its slave terminals.

The following figure indicates the transition for the communication state since the power has been turned ON.

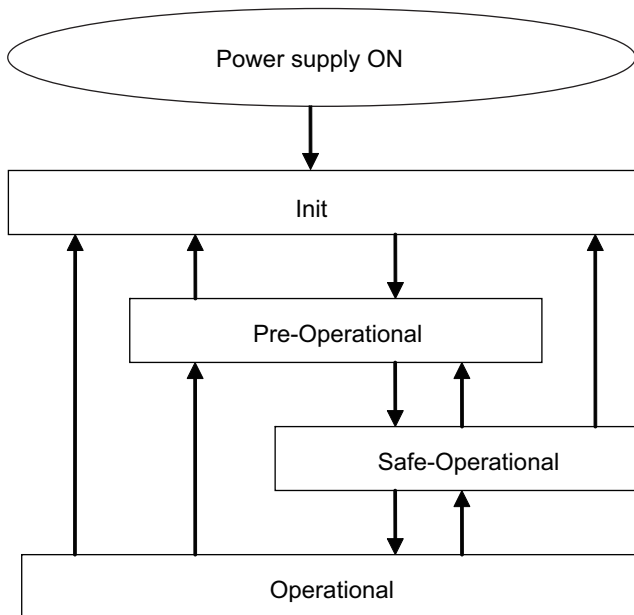

The following table indicates whether or not data objects can be sent or received in each communication state.

Status	SDO communications	Sending PDOs	Receiving PDOs	Description
Init.	Not possible	Not possible	Not possible	Communications is in initialization. Communications are not possible.
Pre-Operational (Pre-Op)	Possible	Not possible	Not possible	Only SDO (message) communications are possible. After the initialization, the network settings is initialized in this state.
Safe-Operational (Safe-Op)	Possible	Possible	Not possible	Sending PDOs in addition to SDO (message) communications are possible in this state. The slave terminals can send Information such as status with sending PDOs.
Operational (Op)	Possible	Possible	Possible	Normal state in communications. The I/O data can be controlled with PDO communications.

2-1-5 Process Data Objects (PDOs)

This section describes the process data objects (PDO) used in EtherCAT communications.

Introduction

Real-time data transfer in cyclic communication uses Process Data Objects (PDOs).

There are two types of Process Data Objects (PDOs): RxPDOs, which are used by the EtherCAT slave terminal to receive data from the EtherCAT master; and TxPDOs, which are used by the EtherCAT slave terminal to send data to the EtherCAT master.

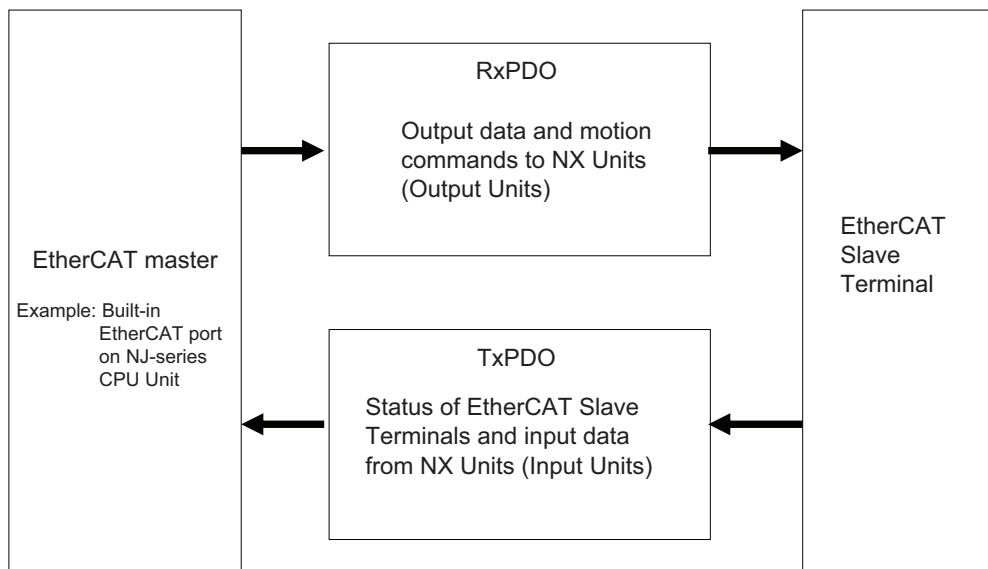

The EtherCAT application layer can hold more than one object to enable the transfer of various process data of the EtherCAT slave terminal.

The contents of the process data is defined in the *PDO mapping objects*.

EtherCAT slave terminals support PDO mapping for I/O control.

PDO Mappings

PDO mapping objects contain the I/O data for EtherCAT slave terminals. PDO mapping objects are managed with indexes in the object dictionary: from 1600 hex to 17FF hex for the RxPDO, and from 1A00 hex to 1BFF hex for TxPDO.

● PDO Mapping Scheme in EtherCAT

The following describes the PDO mapping scheme in EtherCAT.

Three application objects (Object A, B, and D) are allocated to the PDO (name: PDO_1) at index 1ZZZ hex.

Like mentioned above, PDO mappings indicates how application objects are allocated to PDOs. Indexes and sub-indexes are also allocated to application objects.

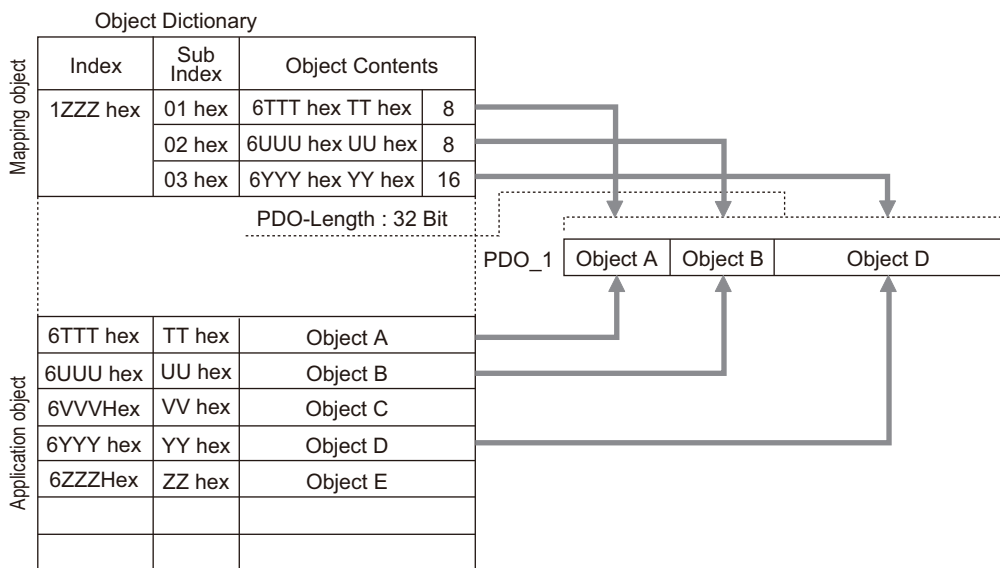

● PDO Mapping for EtherCAT Slave Terminals

EtherCAT slave terminals have PDOs for each EtherCAT coupler unit and the Sensor Controller. Application objects are allocated by default (factory settings) to PDOs for each unit.

The following figure describes a specific example for one of PDOs in a Sensor Controller.

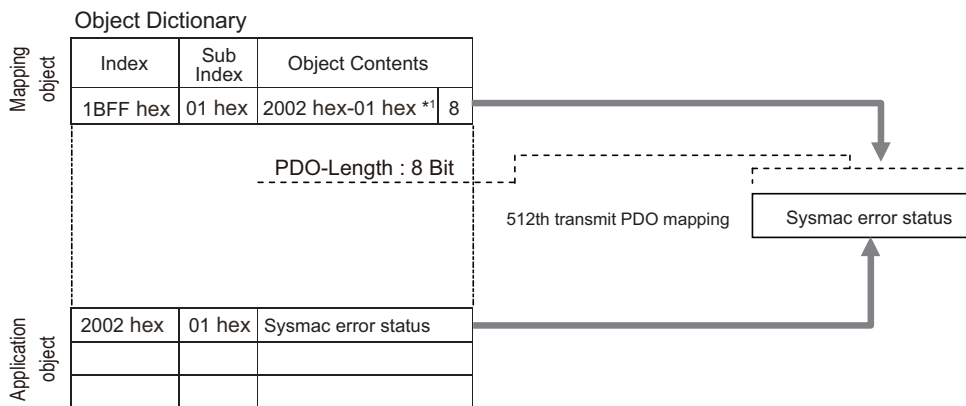

*1. This is expressed as 0x2002:01 on the Sysmac Studio.

In the above example, a single application object is allocated to the PDO at index 1BFF hex (name: 512th transmission PDO mapping). This PDO is for TxPDO. The application object contains the Sysmac error status at index 2002 hex and sub-index 01 hex.

Allocating PDOs

● Scheme for Allocating PDOs to EtherCAT Slaves

Multiple PDOs can be allocated to an EtherCAT slave.

The following example indicates the PDO allocation.

Here, PDOs are allocated to index 1C12 hex for the RxPDO, and 1C13 hex for the TxPDO.

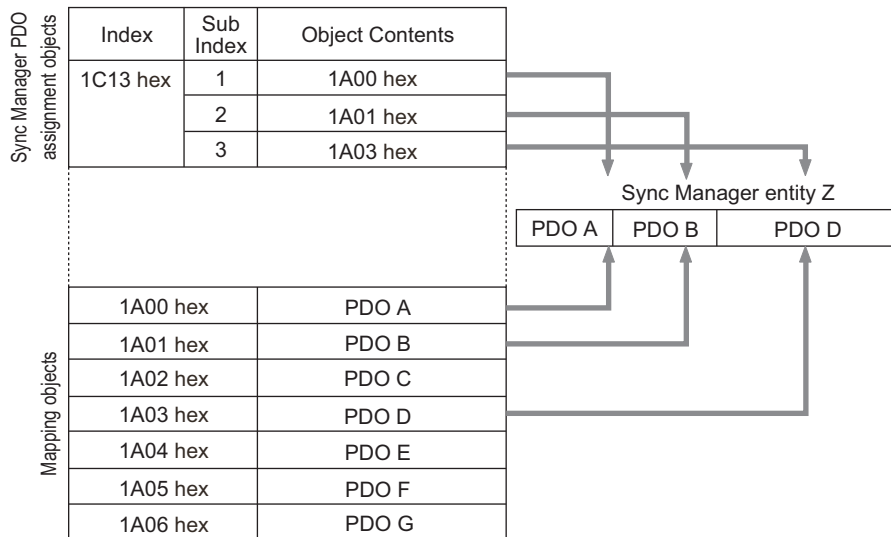

In the example, three PDOs (PDO A, PDO B, PDO D) are allocated to index 1C13 hex for the TxPDO.

Likewise, a PDO for the RxPDO is also allocated to index 1C12 hex.

The above allocation defines the PDO types for communications between the EtherCAT master and slave.

2-1-6 Service Data Objects (SDOs)

This section describes the service data objects (SDO) used in EtherCAT communications.

Introduction

EtherCAT slave terminals support SDO communications.

The EtherCAT master can set parameters and monitor status by reading and writing data from and to entries in the object dictionary using SDO communications.

For the objects that SDO communications are available, refer to *2-1-27 Object Dictionary* on page 2-88.

Abort Codes

The following table lists the abort codes for SDO communication errors.

Abort code value	Meaning
05030000 hex	Toggle bit not changed
05040000 hex	SDO protocol timeout
05040001 hex	Client and server command specifiers not valid or unknown
05040005 hex	Out of memory area
06010000 hex	Unsupported access to an object
06010001 hex	Attempt to read a write-only object
06010002 hex	Attempt to write to a read-only object
06020000 hex	Non-existent object in the object dictionary
06040041 hex	Unable to map the object to the PDO
06040042 hex	Number and length for the mapped object exceed the PDO length.
06040043 hex	General parameter incompatibility
06040047 hex	General internal incompatibility in the device.
06060000 hex	Access failure due to a hardware error.
06070010 hex	Mismatch of data type and service parameter length
06070012 hex	Data type mismatch and service parameter length is too long.
06070013 hex	Data type mismatch and service parameter length is too short.
06090011 hex	Missing sub-index.
06090030 hex	Parameter value is out of range. (Only for write-access)
06090031 hex	Written parameter value is too high.
06090032 hex	Written parameter value is too low.
06090036 hex	Maximum value is smaller than minimum value.
08000000 hex	General error
08000020 hex	Data cannot be transferred or stored to the application.
08000021 hex	Data cannot be transferred or stored to the application because of local control.
08000022 hex	Data cannot be transferred or stored to the application because of the present device state.
08000023 hex	Failed to dynamically create the object dictionary, or no object dictionary exists.

2-1-7 Communications between Master and Slaves for EtherCAT

This section describes the communication modes between the master and slaves for EtherCAT and the communication modes for EtherCAT slave terminals.

Communication Modes for Communications between Master and Slaves for EtherCAT

- **Free-run Mode (FH/FHV series not supported)**

In the free-run mode, a slave performs the I/O processing (updating the I/O data) asynchronously to the communication cycle of the master.

- **DC Mode**

In the DC mode, a slave performs the I/O processing (updating the I/O data) synchronously with the communication cycle of the master. The synchronization in EtherCAT communications uses a distributed clock (DC) to share the same clock in the master and slaves. Interruptions (Sync0) are generated in the slaves at precise intervals based on the clock. Each slave performs the I/O processing at the precise timing.

Communication Modes for EtherCAT Slave Terminals

The FH/FHV series support DC mode. They do not support the free-run mode.

Communication Cycle

The communication cycle is determined by the settings for it in the EtherCAT master.

For details of communication cycle supported by the built-in EtherCAT port in the NJ series CPU units, refer to *NJ-series CPU Unit Built-in EtherCAT Port User's Manual (Cat. No. W505)*.

2-1-8 Communication Method of Sensor Controller Connected by EtherCAT

With commands and responses via communications between an EtherCAT master and a Sensor Controller, the master can control the Sensor Controller and make it output data after measurement.

To connect a Sensor Controller to an NJ series CPU unit by EtherCAT, use Sysmac Studio (standard edition) version 1.09 or later.

Using the Sysmac Studio, the Sensor Controller is registered to the EtherCAT slave configuration on the Edit Network Configuration tab page.

For details of the registration procedures, refer to *Controller Configurations and Setup* in the *Sysmac Studio Version 1 Operation Manual (Cat. No. W504)*.



Precautions for Correct Use

When Sysmac Studio is used in a high load environment, such as input of measurement triggers at short intervals while connected online to the Sensor Controller, there may be deviations in the measurement processing time.

In EtherCAT communications, communications are performed via I/O ports in the following six areas in the Controller. The I/O ports in the Sysmac Error Status Area are used only when a CPU Unit of the NJ series is connected as a EtherCAT master.

Command/response method	(1) I/O ports in the Command Area	These I/O ports are used that you write control commands to perform for the Sensor Controller.
	(2) I/O ports in the Response Area	These I/O ports are used that the Sensor Controller writes the results which the control commands written in the Command Area were performed.
Data output after measurements	(3) I/O ports in the Data Output Area	These I/O ports are used that the Sensor Controller writes the measurement parameters, judgment results, and other results after measurements are performed.
Error status	(4) I/O ports for Sysmac Error Status Area	These I/O ports are used that the Sensor Controller writes the error status. Valid only for Sysmac Studio and Vision Tool used together.
User area	(5) I/O ports in the user input area	These I/O ports are used that you write the data that you defined for the Sensor Controller.
	(6) I/O ports in the user output area	These I/O ports are used that the Sensor Controller write the data that you defined for the Sensor Controller.

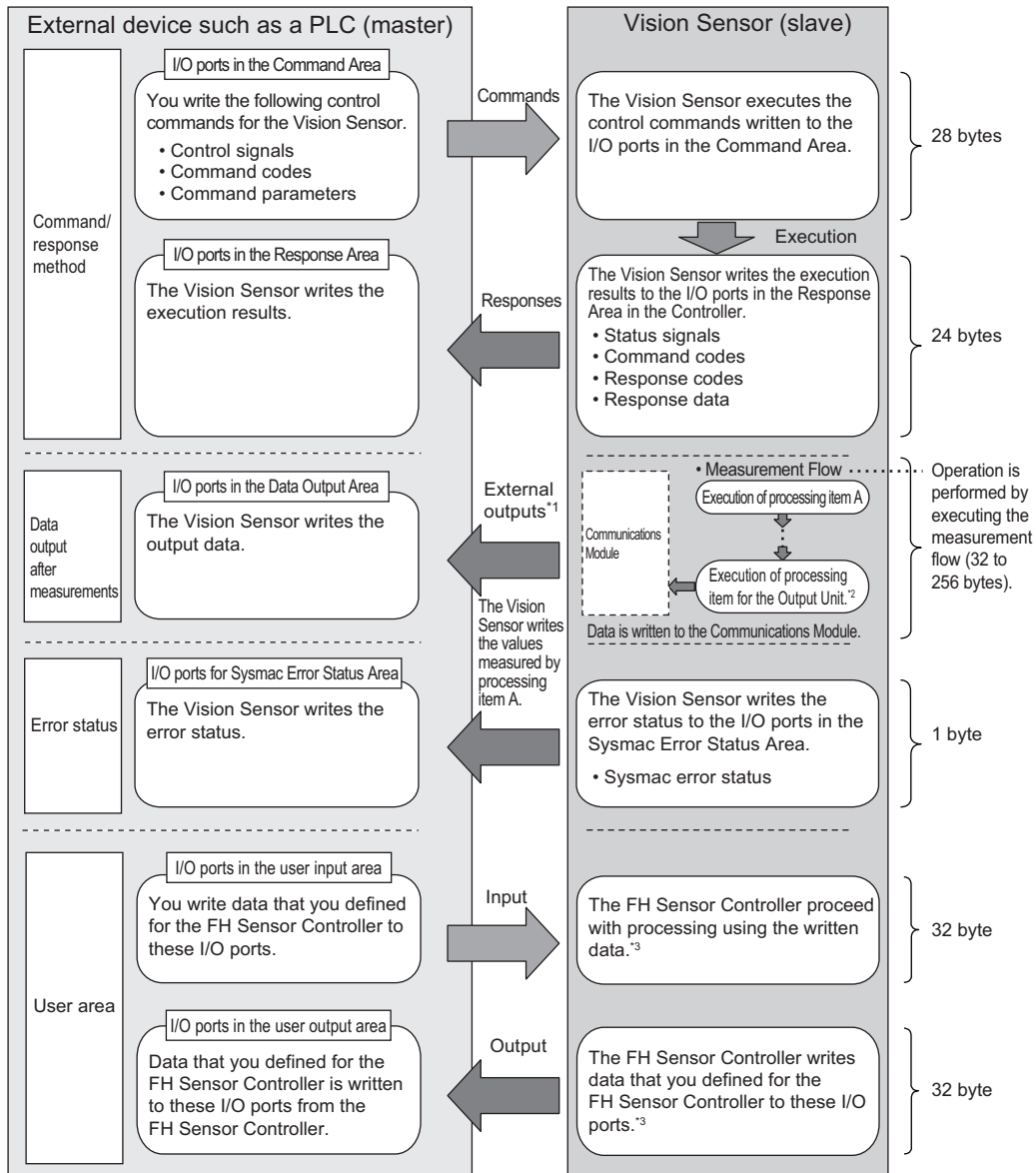

*1: You can use output controls (handshaking) to prevent output data from being externally output from the communications buffer until the external device such as a PLC(master) turns ON the Result Set Request signal to request the output data.

*2: For details of the Output Units outputting measurement data, refer to *Settings Required for Data Output* on page 1-20.

*3: Use the Macro Customization Function to input and output to the User Area. For details of the Macro Customization Function, refer to *EtherCAT communication of the IO Module List* in the *Vision System FH Macro Customize Functions Programming Manual (Cat. No. Z367)*.

Communications in Multi-line Random-trigger Mode

In Multi-line Random-trigger mode, a Sensor Controller for the FH series can control up to eight lines. In Multi-line Random-trigger mode, the I/O ports (areas) for communications between the Sensor Controller and the master are allocated as shown below.

Command/response method	I/O ports in the Command Area	Allocated for each line.
	I/O ports in the Response Area	
Data output after measurements	I/O ports in the Data Output Area	
User area	I/O ports in the User Input Area	
	I/O ports in the User Output Area	
Error status	I/O ports for Sysmac Error Status Area	The same for all lines.

Independent areas for PDO communications are allocated for each line by allocating a Module (line) to each EtherCAT communication slot using Sysmac Studio (standard edition).

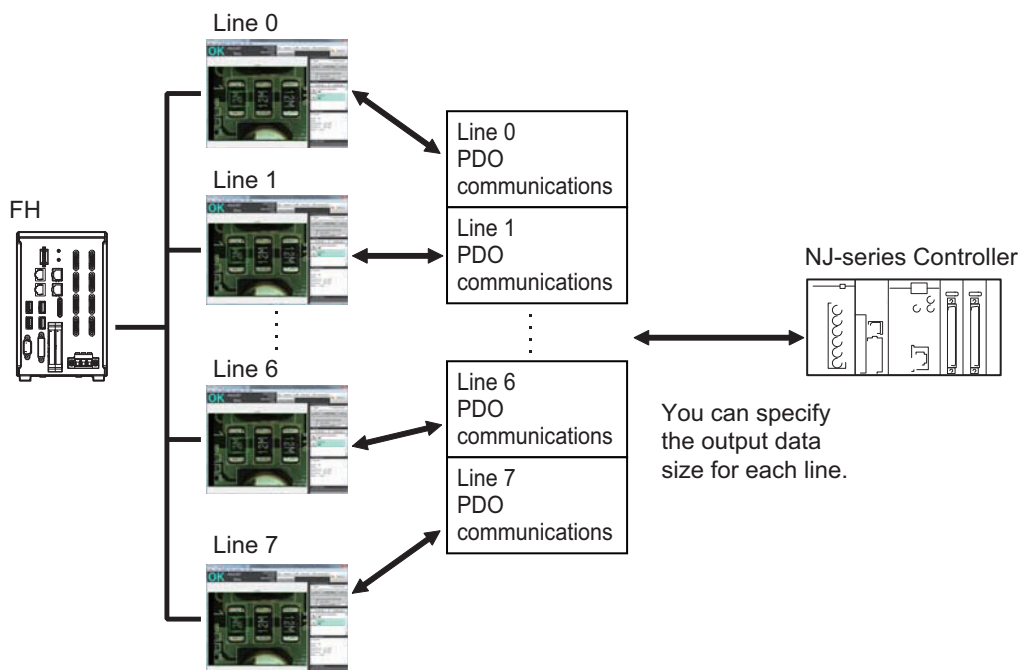

● Available Size for Output Data

The upper limits for the output data size depend on the number of lines and User Area to be used as shown below.

Number of lines	Not Using User area	Using User area
1 line	Max. 256 bytes	Max. 256 bytes
2 lines		
3 lines		
4 lines		
5 lines		
6 lines	Max. 128 bytes	Max. 128 bytes
7 lines		
8 lines		

● Minimum PDO Communication Cycle Time

Do not set the communication cycle (PDO communication cycle time) for EtherCAT communications to a value lower than the minimum time in the following table.

The minimum communication cycle time (PDO communication cycle time) depends on the number of lines to control, the number of bytes for output data, and the User Area to use as shown below. In Multi-line Random-trigger mode, the minimum value for the communication cycle is the minimum value for the maximum byte size for each line.

If the communication cycle (PDO communication cycle time) were set lower than the minimum value below, a slave application error (AL status code: 0035 hex) will occur and EtherCAT communication will become unavailable.

Not Using User area

Number of lines to be controlled	Byte size of output data			
	32 bytes	64 bytes	128 bytes	256 bytes
1 line	125 μ s			250 μ s
2 lines	250 μ s			
3 lines	250 μ s		500 μ s	
4 lines	500 μ s			1000 μ s
5 lines	500 μ s			1000 μ s
6 lines	500 μ s		1000 μ s	Unavailable
7 lines	500 μ s		1000 μ s	Unavailable
8 lines	1000 μ s			Unavailable

Using User area

Number of lines to be controlled	Byte size of output data			
	32 bytes	64 bytes	128 bytes	256 bytes
1 line	125 μ s		250 μ s	
2 lines	250 μ s			500 μ s
3 lines	500 μ s			1,000 μ s
4 lines	500 μ s		1,000 μ s	
5 lines	500 μ s		1,000 μ s	
6 lines	1,000 μ s			Unavailable
7 lines	1,000 μ s			Unavailable
8 lines	1,000 μ s		Unavailable	



Precautions for Correct Use

The communication cycle of EtherCAT communication depends on the number of slaves and the total data size.

Check and calculate each component such as the transmission delay time of the external device such as a PLC (master) as well as the minimum value of the above "sensor controller (slave)".

For details on the calculation method, refer to the manual of the connected external device such as a PLC(master).

Applicable Models

- **OMRON**

OK: Can connect, Cond.: Only some models can connect, NG: Cannot connect

Series	CPU unit	Interface	
		Direct connection with CPU unit (Built-in port)	Connection via master unit
SYSMAC NJ/NX	NJ501, NJ301, NJ101, NX701	OK	-

- **Beckhoff**

TwinCAT PC edition, Industrial PCs, Embedded PCs

(When you use a Beckhoff's master, contact us to get an ESI file for Sensor Controllers of the FH series.)

2-1-9 Communications Settings

The following settings are required to use EtherCAT communications.

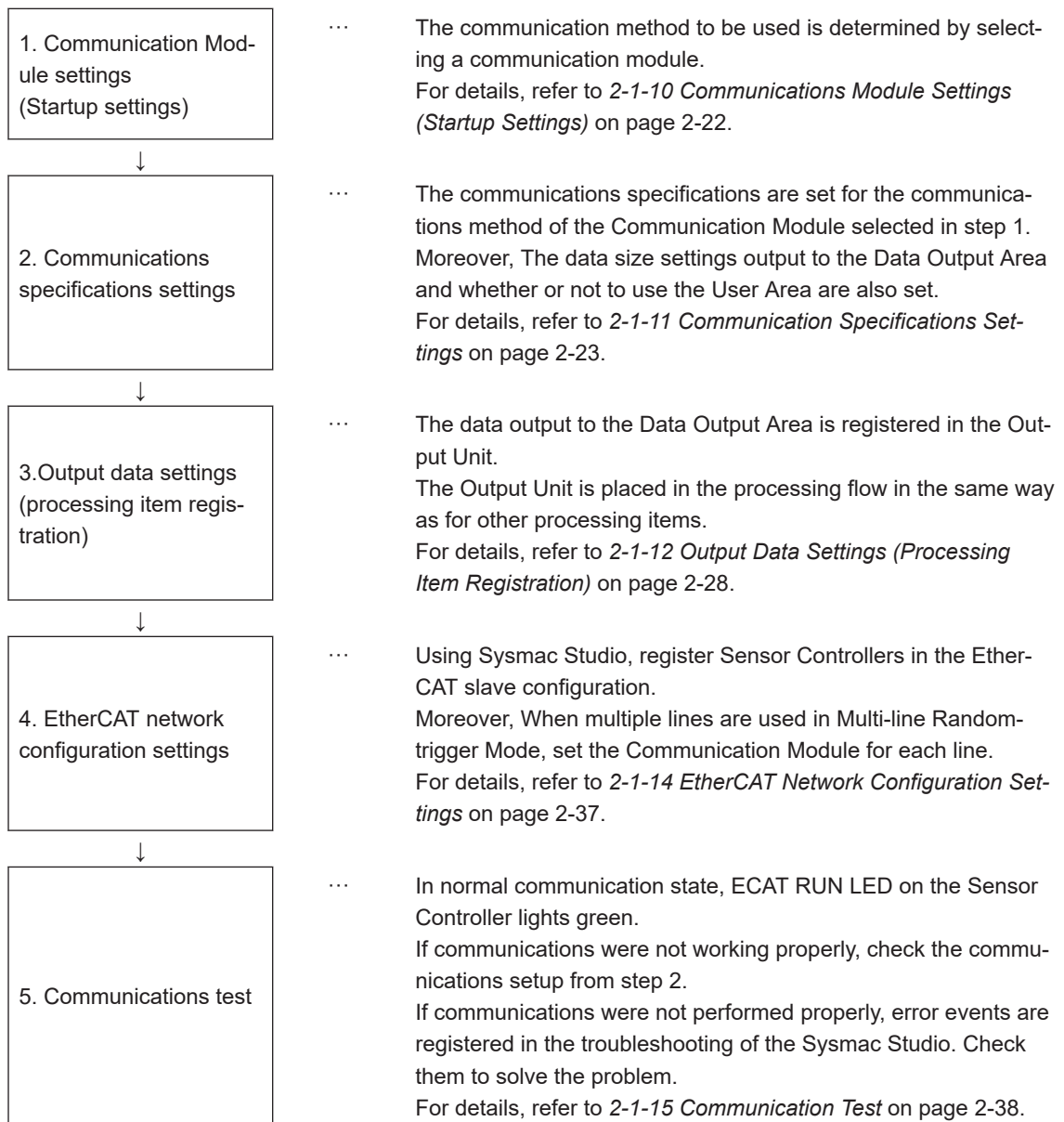



Additional Information

Communications are set up as shown below when you use the Multi-line Random-trigger mode.

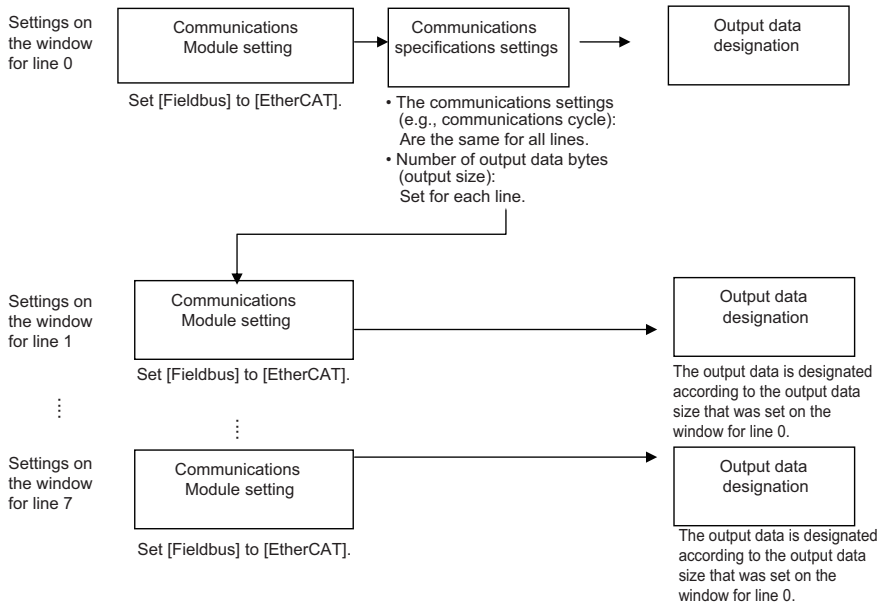

2-1-10 Communications Module Settings (Startup Settings)

- 1 On the Main window, click **Tool - System Settings** to open the system settings.
- 2 On the Multiview Explorer on the left, select **System settings - Startup - Startup setting** and then click the **Communication** tab.

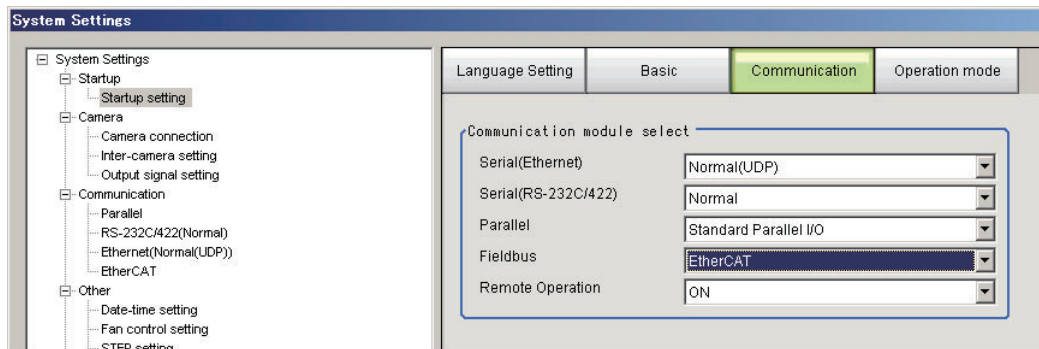

- 3 In the Communication Module Selection Area, select *EtherCAT* in the *Fieldbus*, and then click **Apply**.

- 4 Click **Data save** in the Toolbox Pane.

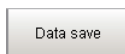

- 5 On the Main window, click **Function - System restart**.
- 6 Click **OK** in the System restart dialog box to restart the Sensor Controller. When the Sensor Controller was restarted, the set Communication Module will operate with the default settings.
- 7 Set the IP address and other parameters for external devices such as a PLC.



Precautions for Correct Use

If you will use the Multi-line Random-trigger mode for EtherCAT communications for multiple lines, use the following procedure to set the Communications Module.

- (1) In the Communications Module settings for line 0, set the *Fieldbus* Box to *EtherCAT*, save the setting to the Vision Sensor, and then restart the system.
- (2) After the system has been restarted, set the *Fieldbus* Box to *EtherCAT* in the Communications Module settings for line 1, save the setting to the Vision Sensor, and then restart the system. Repeat this step for the rest of the lines.



Additional Information

You can save the Communication Module settings to a file. Use the *System data* or *System + Scene group 0 data* option for saving settings to a file. For details, Refer to *Saving Settings Data to the Controller RAM Disk or an External Storage Device* in the *Vision System FH/FHV Series User's Manual (Cat. No. Z365)*.

2-1-11 Communication Specifications Settings

Here, set output data size, output handshaking, and output controls to perform EtherCAT communications.



Precautions for Correct Use

- Use the same communications specifications settings for the Sensor Controller and the external device.
- Do not input signals to EtherCAT from an external device while performing the EtherCAT system settings.
- Before you set the communications specifications, set the Communications Module to *EtherCAT*.
Restart the system after you save the data to the Vision Sensor.
For details, Refer to *2-1-10 Communications Module Settings (Startup Settings)* on page 2-22.

- 1 On the Main window, click **Tool - System Settings** to open the system settings.
- 2 Select **System Settings** and then select **Communications - EtherCAT**. Communication settings window appears.
- 3 Set each item.

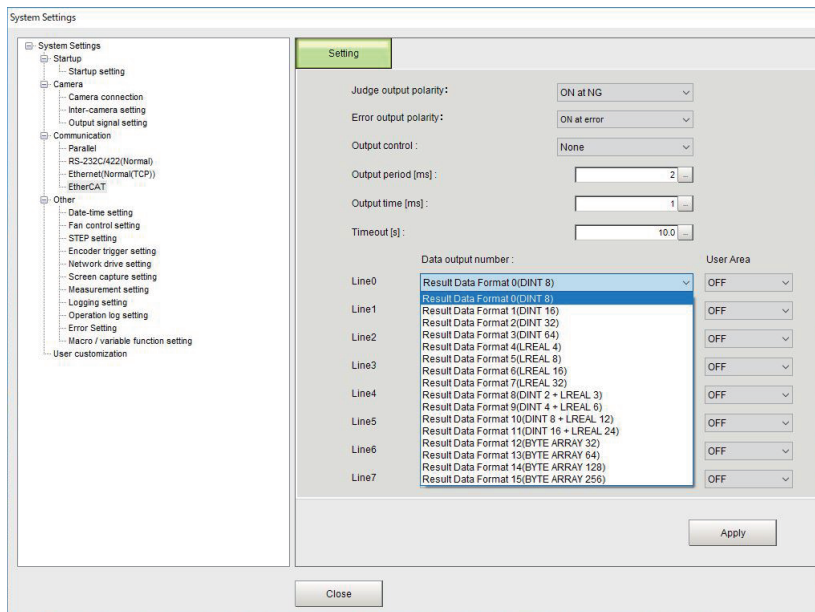

Setting item	Setting value [Factory default]	Description
Judge output polarity	<ul style="list-style-type: none"> • ON at OK • [ON at NG] 	<p>ON at OK: ON when the judgment result is OK. For the overall judgment, ON when all judgment results are OK.</p> <p>ON at NG: ON when the judgment result is NG. For the overall judgment, ON when one of the judgment results is NG.</p>
Error output polarity	<ul style="list-style-type: none"> • [ON at error] • OFF at error 	<p>ON at error: ON when an error occurs.</p> <p>OFF at error: OFF when an error occurs.</p>
Output control	<ul style="list-style-type: none"> • [None] • Handshaking 	<p>None: The Sensor Controller outputs measurement results without synchronizing with external devices.</p> <p>Handshaking: The Sensor Controller outputs measurement results with synchronizing with external devices.</p>
Output period [cycle]	2 to 5,000 [2]	<p>Set the cycle by which measurement results are output.</p> <p>Set the number of cyclic communications of the EtherCAT PDO communication cycle after which to output the measurement results from the Sensor Controller.</p>
Output time [cycle]	1 to 1,000 [1]	<p>Set the cycle by which the output of measurement results are held.</p> <p>Set the number of EtherCAT PDO communication cycles to hold the output from the Sensor Controller.</p>
Timeout [s]	0.5 to 120.0 [10.0]	<p>Valid only when <i>Handshaking</i> is set to <i>Output Control</i>.</p> <p>Set the timeout time.</p> <p>A timeout error will occur if external devices could not perform handshaking within the time set here.</p>

Setting item	Setting value [Factory default]	Description
Line n Data Output number		Set the number of data items to output for each line. There are two types in the output data size: 4 bytes (DINT) and 8 bytes (LREAL). Select the output data size and the number of outputs from the types below.
		Result Data Format 0 (DINT 8) Eight 4-byte data items are output. (Total: 32 bytes)
		Result Data Format 1 (DINT 16) Sixteen 4-byte data items are output. (Total: 64 bytes)
	• Result Data Format 0 (DINT 8)	Result Data Format 2 (DINT 32) Thirty-two 4-byte data items are output. (Total: 128 bytes)
	• Result Data Format 1 (DINT 16)	Result Data Format 3*1 (DINT 64) Sixty-four 4-byte data items are output. (Total: 256 bytes)
	• Result Data Format 2 (DINT 32)	Result Data Format 4 (LREAL 4) Four 8-byte data items are output. (Total: 32 bytes)
	• Result Data Format 3 (DINT 64)	Result Data Format 5 (LREAL 8) Eight 8-byte data items are output. (Total: 64 bytes)
	• Result Data Format 4 (LREAL 4)	Result Data Format 6 (LREAL 16) Sixteen 8-byte data items are output. (Total: 128 bytes)
	• Result Data Format 5 (LREAL 8)	Result Data Format 7*1 (LREAL 32) Thirty-two 8-byte data items are output. (Total: 256 bytes)
	• Result Data Format 6 (LREAL 16)	Result Data Format 8 (DINT 2 + LREAL 3) Two 4-byte data items and three 8-byte data items are output, for a total of five data items. (Total: 32 bytes)
	• Result Data Format 7 (LREAL 32)	Result Data Format 9 (DINT 4 + LREAL 6) Four 4-byte data items and six 8-byte data items are output, for a total of 10 data items. (Total: 64 bytes)
	• Result Data Format 8 (DINT 2 + LREAL 3)	Result Data Format 10 (DINT 8 + LREAL 12) Eight 4-byte data items and twelve 8-byte data items are output, for a total of 20 data items. (Total: 128 bytes)
• Result Data Format 9 (DINT 4 + LREAL 6)	Result Data Format 11*1 (DINT 16 + LREAL 24) Sixteen 4-byte data items and twenty-four 8-byte data items are output, for a total of 40 data items. (Total: 256 bytes)	
• Result Data Format 10 (DINT 8 + LREAL 12)		
• Result Data Format 11 (DINT 16 + LREAL 24)		

Setting item	Setting value [Factory default]	Description	
	<ul style="list-style-type: none"> Result Data Format 12 (ByteArray 32 byte) Result Data Format 13 (ByteArray 64 byte) Result Data Format 14 (ByteArray 128 byte) Result Data Format 15 (ByteArray 256 byte) 	Result Data Format 12 (ByteArray 32 byte)	A character string of 32 bytes is output.
		Result Data Format 13 (ByteArray 64 byte)	A character string of 64 bytes is output.
		Result Data Format 14 (ByteArray 128 byte)	A character string of 128 bytes is output.
		Result Data Format 15 (ByteArray 256 byte)	A character string of 256 bytes is output.
User area	<ul style="list-style-type: none"> [OFF] ON 	Set whether or not to use the user area (user input area/user output area) for each line.	

*1. When you control six to eight lines in Multi-line Random trigger mode, you cannot use the output data size of 256 bytes.

4 Click **Apply**.



Precautions for Correct Use

If you change any of the *Line N Data Output Number* and *User area* settings, restart the Controller.



Additional Information

If you use alignment, select the data type of the output data according to the application.

- DINT Data:
This data type holds a single-precision floating-point number. Coordinate values are multiplied by 1,000 and are output as integers. Only 1/1,000 of the precision is output.
- LREAL Data:
This data type holds a double-precision floating-point number. If you use alignment, coordinate values are output as double-precision floating-point numbers. This allows you to output the actual values to an external device. However, processing 64-bit calculations on the NJ-series Controller or other PLC will be slower than processing 32-bit calculations.
- ByteArray Data:
This is used to output a character string. (Other than characters cannot be output.)
 - 1) Select *Result Data Format* on the EtherCAT setting screen in the Sensor Controller of the FH/FHV series. (Data with *Array of Byte* format is output to the NJ series Controller.)
 - 2) Use the *AryToString* command in the program on the NJ series Controller to convert the received data with *Array of Byte* format to *String* format.

EtherCAT Communications Settings for Multi-line Random-trigger Mode

When you use Multi-line Random-trigger mode to perform EtherCAT communications on multiple lines, you can only configure EtherCAT communication settings on line 0 Setting tab page.

The EtherCAT communication settings on multiple-line are as follows.

Setting item	Description
Output control	Common settings for all lines
Output period	Common settings for all lines
Output setting	Set for each line. The settings of the Fieldbus data output for each line vary depending on the settings of the number of Data Output. For details, refer to 2-1-12 <i>Output Data Settings (Processing Item Registration)</i> on page 2-28.

2-1-12 Output Data Settings (Processing Item Registration)

Here, set the output items and output format to be used with EtherCAT.

This processing item is not available in the FHV series. When you set output data in the FHV series, refer to *2-1-13 Setting Output Data (Numerical Values/Character Strings)* on page 2-31.

Registering Processing Items

Register the processing items for data output in the measurement flow.

- 1 Click **Edit flow** in the Toolbox Pane.
- 2 Select the **Fieldbus Data Output** processing item in the processing item tree.

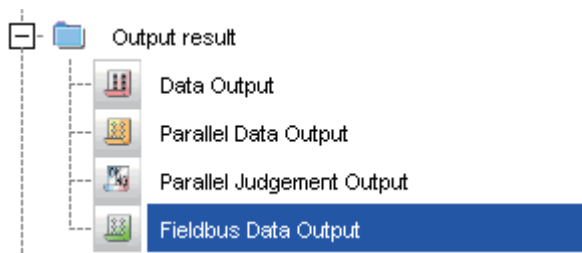

- 3 Click **Append**.
The **Fieldbus Data Output** processing item is added at the bottom of the unit list (flow).

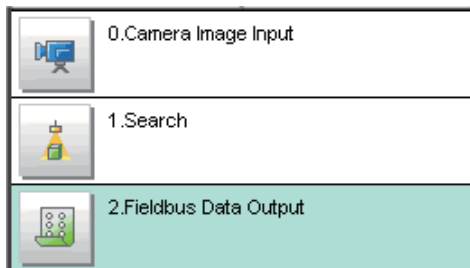

- 4 Click the **Fieldbus Data Output**  icon and set the data output items and data format.
For details of the settings, refer to the following.
Setting the Output Data on page 2-29



Precautions for Correct Use

Fieldbus Data Output

Perform the communication settings before the settings of Fieldbus Data Output.

Note that if you changed the communication settings after the settings of Fieldbus Data Output, the changed settings will not be displayed on the Fieldbus Data Output setting display.



Additional Information

- Depending on the Data Output Number setting for the line, you can set from 4 to 64 data items for output with one data output processing item.
Examples:
DINT16: You can register up to 16 data items.
LREAL 24: You can register up to 24 data items.
For the number of data items that you can output for each Data Output Number setting., refer to *2-1-11 Communication Specifications Settings* on page 2-23.
If you need to output more data items than given above, use more than one Output Unit. However, the data is output to the same destination, so if you do not control the output, the data that was output first will be overwritten by the subsequent data.
Use the following method to read each set of output data.
 - Controlling Data Output with Handshaking
When handshaking is used to control data output, the timing of outputting the data is controlled by I/O signals.
Each time that data is output, read the output data and move it to a different part of I/O memory in the PLC.
For more information on handshaking, refer to *Data Output Control with Handshaking* on page 1-24.
- Data is output in the order of registration in the measurement flow, with each data output processing item executed at a different timing. (Data output is executed in the order that it is registered in the measurement flow.)
For details, refer to *Outputting the Measurement Data* on page 1-18.

Setting the Output Data

Set the output data with expressions.

Set the expression for each four-byte data (DINT) and eight-byte data (LREAL).



Additional Information

The Fieldbus Data Output setting item changes according to the EtherCAT communications settings. Set the total output data size (256 bytes max.) and the number of data items to output (64 max.) in the EtherCAT communications settings in advance.

- Click the Fieldbus Data Output  icon in the measurement unit list (flow).
- The Fieldbus Data Output window is displayed.
The **DINT Setting** and **LREAL Setting** tabs and the number of the output data are displayed according to the EtherCAT communication settings.
- In the item tab area, click either tab, **DINT Setting** or **LREAL Setting**.
The **DINT Setting** and **LREAL Setting** tabs are displayed according to the EtherCAT communication settings.
- In the list, click the output data number to set the expression.

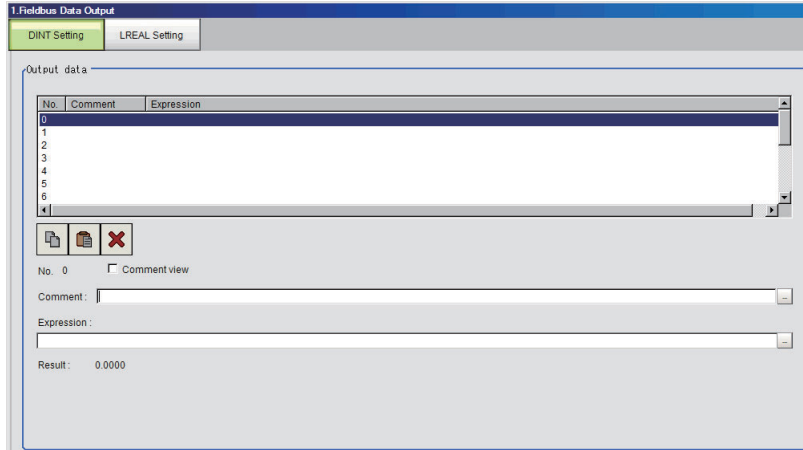

The selected output data number is displayed under the list.

- 5** Click  next to the expression text box and set the expression.



Specify the processing items, measurement results, and measurement data in the expression. Arithmetic or function calculations can be applied to the measurement data to output. For details of the calculation settings, refer to *Calculation* in the *Vision System FH/FHV Series Processing Items Reference Manual (Cat. No. Z341)*.

- 6** Click  for the **Comment** text box and enter the description for the expression. The entered comment will be displayed in the detailed results area on the Main window. For example, *Test* was entered as the comment for the expression 0, *Test* will be displayed instead of *Expression 0* in the detailed results areas on the Main window.
- 7** Repeat step 4 to 5 to set expressions for each output data number.
- 8** In the item tab area, click either tab, **DINT Setting** or **LREAL Setting** and set the expressions in the same way as for step 3 to 5 above.



Additional Information

If you delete one of the expressions that is set for an output data number, 0 is output for the output data for that number.

2-1-13 Setting Output Data (Numerical Values/Character Strings)

Registering Processing Items

Register the processing items for data output in the measurement flow.

- 1 In the Main window, click **Edit flow** in the Toolbox Pane.
- 2 Click **Result output (I/O)** in the processing item tree.

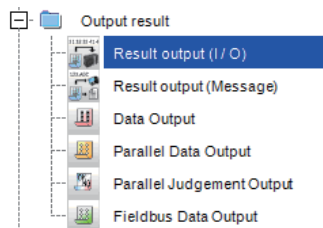

- 3 Click **Append**.
The **Result output (I/O)** processing item is added at the bottom of the unit list (flow).

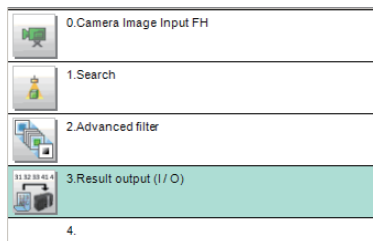

- 4 Click **Result output (I/O)**  icon in the unit list (flow) or **Set** to set the output device and the output data.

Setting the Output Device

Here, set a communication method when data is output.

- 1 Click **Result output (I/O)**  icon in the unit list (flow) or **Set** to set the output device and the output data.

The **Result output (I/O)** setting window is displayed.

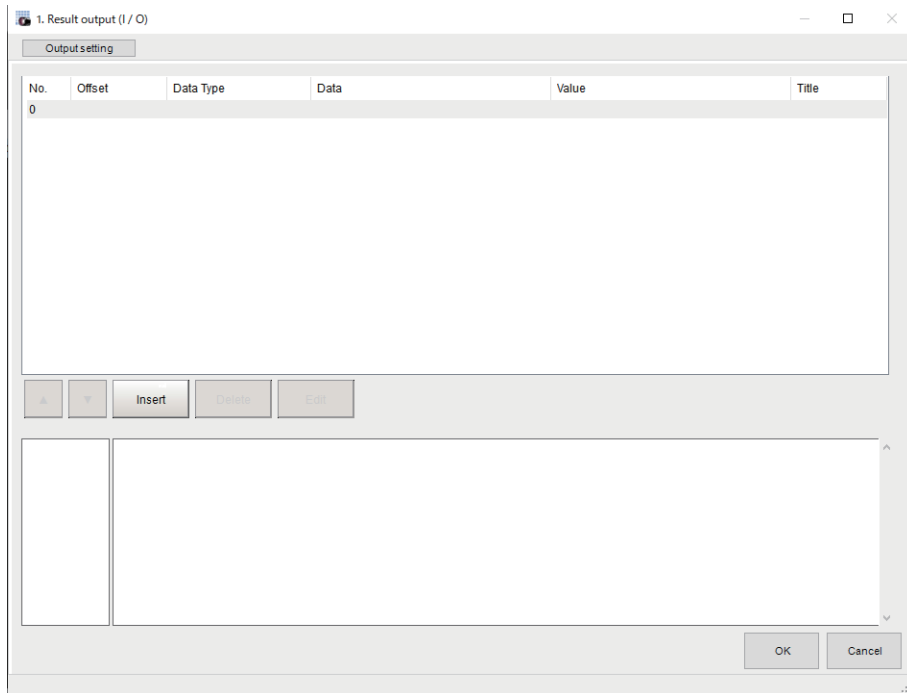

- 2 Click **Output setting**.
The **Output setting** window is displayed.

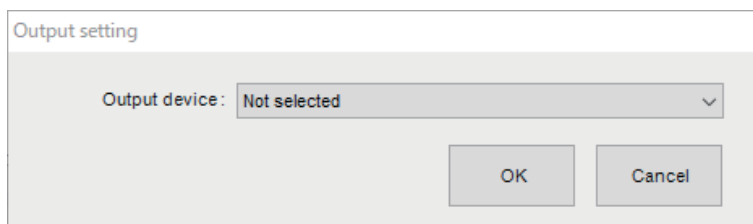

- 3 Click  at the right side of the **Output device**. Select *Fieldbus*.

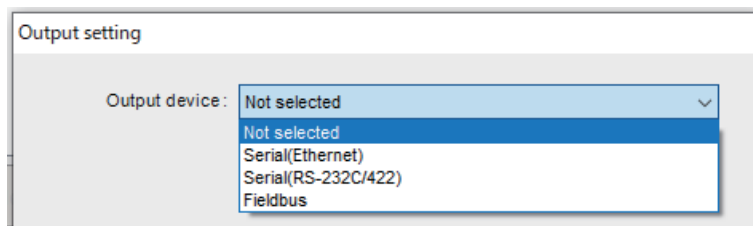



Precautions for Correct Use

- The displayed output device is determined based on the selection of **Communication module** in the **System settings** in the item tab.
- Executing measurements without an output device selected causes a failure (NG: No measurement) in the judgment of the processing unit.

Setting the Output Data

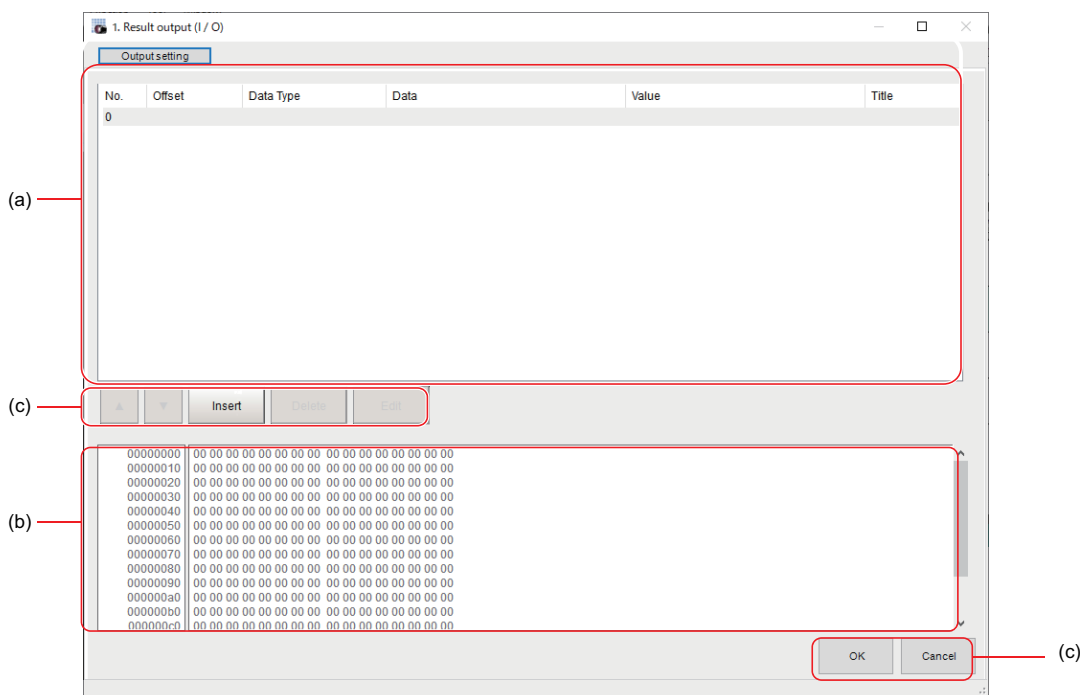

Here, set the data to output such as processing item data or fixed character strings.

- 1 In the item tab area, click **Output data**.
The **Result output (I/O)** setting window is displayed.



- a) Setting data display area
The No. (output number), Offset (indicating the byte position from the beginning), Data type (integer, double, string), Data, Value, and Title (data description) are displayed in this area. A value is displayed when a variable is assigned to data.
- b) Output data display area
Contents in the output data display area in binary (hex) are displayed in this area.
- c) Button

Button	Description
	Moves the selected data up one position.
	Moves the selected data down one position.
	Adds new data to the selected data position.
	Deletes the selected data. The following data moves up after the deletion.
	Edits the selected data.

Button	Description
	Saves the current settings and returns to the previous view.
	Discards the current settings and returns to the previous view.

2 In the list, select the output data number to set the output and then click **Insert**.
The following **Output data editing** dialog box is displayed.

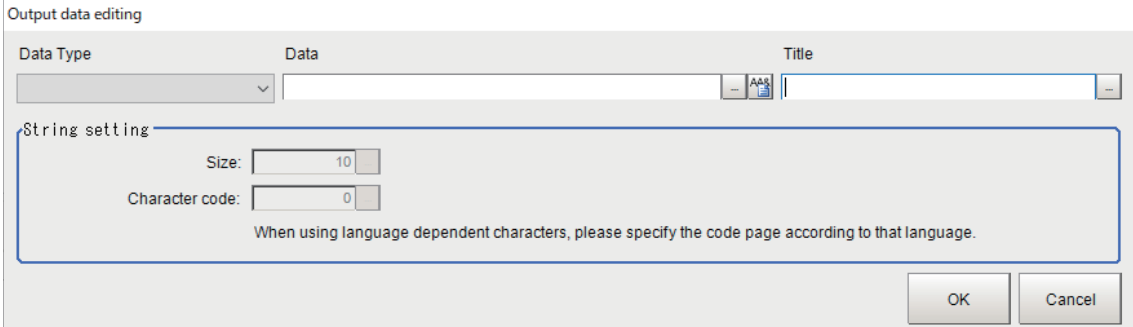

Setting item	Setting value [Factory default]	Description
Data type	<ul style="list-style-type: none"> Integer Double String 	Sets the data type.
Data	—	There are two input methods.*1 <ul style="list-style-type: none"> Enter strings directly Assign variables
Title	—	Enters the description for data.
String settings		Valid when <i>String</i> is selected in the “Data type”.
Size	0 to 4,095 [10]	Sets the number of characters. The number of characters that can be output depends on the data size setting for the tag and tag-set settings in the PLC.
Character code	[0]	Sets the code page according to the language to be used.

*1. Any arithmetic expression cannot be used. If it is used, it will be handled as character strings.

- Character code: Specify the following code page for each language.

Language	Code page	Language	Code page	Language	Code page
Japanese	932	English	1252	Chinese (simplified)	936
German	1252	French	1252	Chinese (traditional)	950
Italian	1252	Spanish	1252	Korean	949
Vietnamese	1258	Polish	1250		

- The default 0 is no language-dependent letters in ANSI code page.
- If non-existing code page is selected, corresponding data is handled as invalid data (NULL).

3 Click  at the right side of the **Data type** text box to select the data to output.
Integer, *Double*, or *String* are selectable.

Data type	Description
Integer	<ul style="list-style-type: none"> Entered data is handled as four-byte data. Allowable entering range is a range of signed INT. When string variables are specified for data, character strings like digits which can be converted into numerical values will be converted and output. When decimal digits are included, they are truncated. Moreover, they are handled as "0" if they are not convertible.
Double	<ul style="list-style-type: none"> Entered data is handled as eight-byte data. The allowable entering range is a range of eight-byte floating decimal value. When string variables are specified for data, character strings like digits which can be converted into numerical values will be converted and output. Moreover, they are handled as "0" if they are not convertible.
String	<ul style="list-style-type: none"> Entered data is set based on specified <i>Size</i>. Example: Size is four and the entered data is ABCD. ABCD → ABC+NULL The number of allowable entering characters is up to 4,095. If this limit is exceeded, nothing is displayed and output. When NULL is included in the entered character string, the character string following NULL is not output. The following escape sequence codes can be entered. The entered escape sequence codes are handled as fixed character strings. \N: Carriage return, \r: Line feed, \t: Tab, \xXX: ASCII code specified by "XX" (numerical value), \": Double quotation mark, \: Backslash

4 Enter data into *Data* text box.

Data that can be output with one data No. is a range only to be handled as one string.

- 1) When directly entering an output content into the **Data** text box.
 - A string enclosed with " " (double quotation marks) handled as one string and the rest following it is not output.
 - Example: "AA"TEST → only "AA" is output.
- 2) In the case where assignment variable is assigned o data:
 - Directly enter a variable name (Scene variable: SC.~) or specify a variable in *Variable assignment* window displayed by clicking .
 - Only one variable is valid for one data No.
Example: SC.A\$+SC.B\$ → Only SC.A\$ is output.
 - When a fixed string, e.g. AA, is entered before a variable, the subsequent variable is also handled as a fixed string.
Example: AA+SC.AA& → "AA+SC.AA&"
 - When "String" is selected in the "Data type" but "Integer" or "Double" is set to the variable, then the variable is converted to a string and then output.

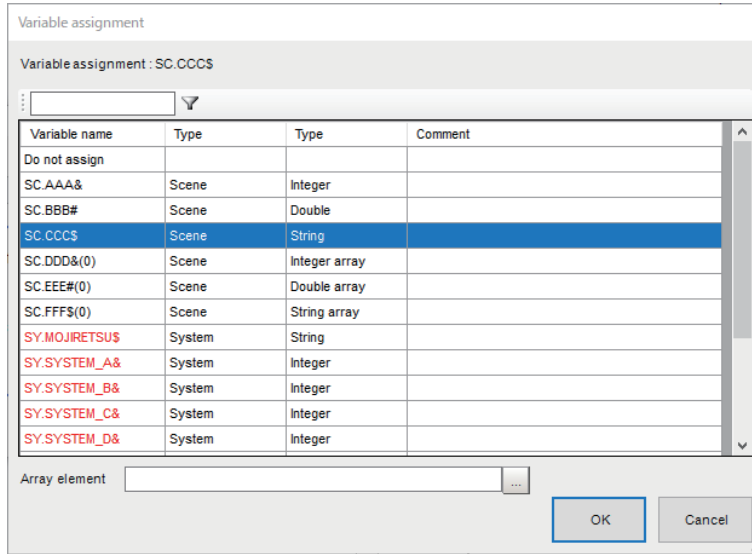

5 Enter *Title* that indicates the content of output data.

6 When *String* is selected in *Data type*, the following items in *String setting* area also needs to be set.

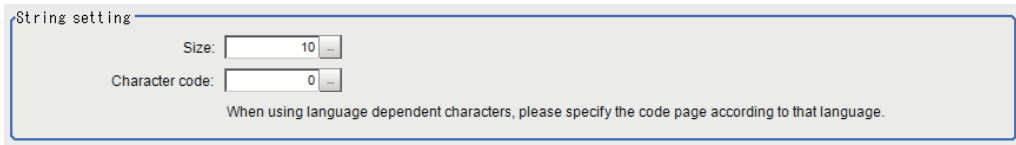

Example:

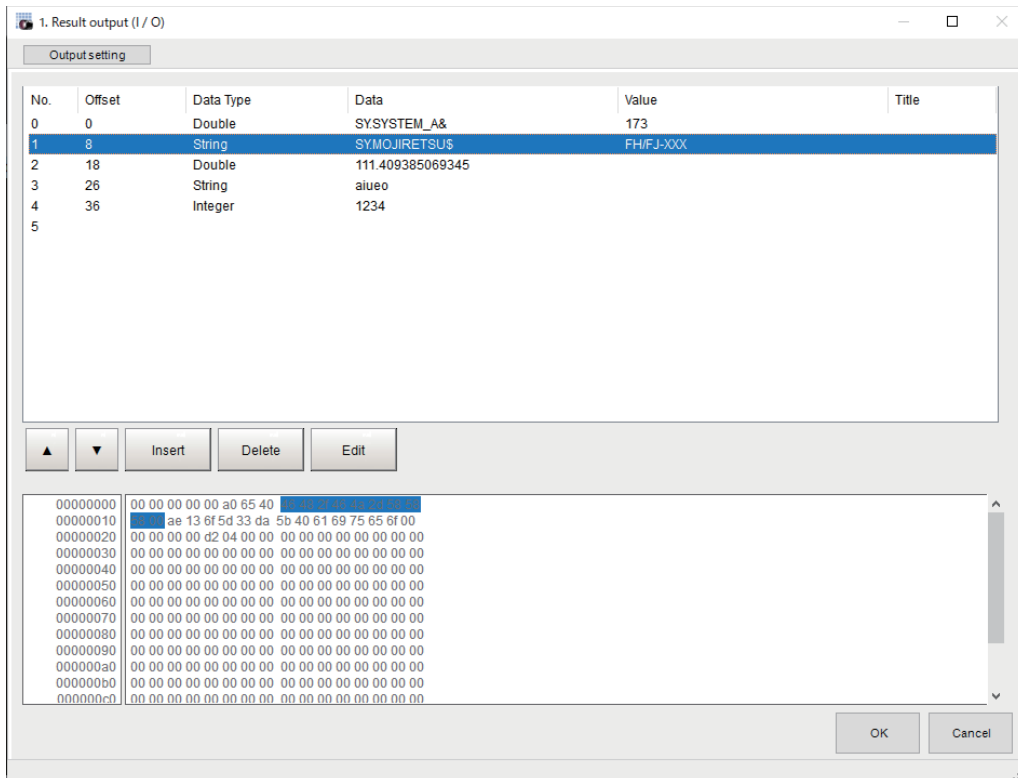

7 Click **OK** in the end of entering data to close the settings.

2-1-14 EtherCAT Network Configuration Settings

To communicate with an NJ series Controller using EtherCAT, use the Sysmac Studio to register the Sensor Controller to the network configuration.



Precautions for Correct Use

To connect the Sensor Controller to an NJ/NX series Controller by EtherCAT, first connect Sysmac Studio to with the Sensor Controller online and then perform the EtherCAT network configuration.

Registering the Sensor Controller in the EtherCAT Slave Configuration

Using the Sysmac Studio, the Sensor Controller is registered to the EtherCAT slave configuration on the Edit Network Configuration tab page.

For details of the registration procedures, refer to *Controller Configurations and Setup* in the *Sysmac Studio Version 1 Operation Manual (Cat. No. W504)*.



Precautions for Correct Use

Use Sysmac Studio Standard Edition version 1.09 or later to perform the settings for the EtherCAT connections between the Sensor Controller and an NJ-series Controller.

Setting the Data Output Size

Use the Sysmac Studio to assign individual PDO communication area for each line in the master according to the Data Output Number settings in the EtherCAT communication specifications settings in the Sensor Controller.

There are two setting methods.

● Online Settings

When the data output size has already set in the Sensor Controller, follow the procedures below to perform the settings for the Sysmac Studio.

- 1 Connect the Sysmac Studio to the Sensor Controller on-line.
- 2 Make the Sensor Controller off-line after on-line connection, the setting data will be loaded to the Sysmac Studio.
- 3 PDO communication areas will be assigned in the master according to the setting conditions of the EtherCAT communication specifications too.

● Offline Settings

When the data output size has not yet set in the Sensor Controller and it will be set by the Sysmac Studio, follow the procedures below in offline state.

- 1 Display the window to edit the system data for the Sensor Controller.

- 2** Display the EtherCAT settings window and select the check boxes for the EtherCAT settings.
- 3** Restart the FH/FHV tool to reflect the settings.
- 4** After the simulator was restarted, display the EtherCAT settings window again and set the Data Output Number for each line.
- 5** Restart the FH/FHV tool to reflect the settings.
PDO communication areas will be assigned in the master according to the setting conditions of the EtherCAT communication specifications too.



Additional Information

If you change any parameter that requires that the Sensor Controller be restarted,  will be displayed by the model in the Multiview Explorer. If this icon is displayed, restart the Sensor Controller.



Precautions for Correct Use

If six to eight lines are controlled in Multi-line Random-trigger mode, settings where the data output size (data output number) is 256 bytes*1 cannot be used. If such 256-byte data output size is set, a warning mark will appear in Sysmac Studio.

*1: Three types: *Result Data Format 3 (DINT 64)*, *Result Data Format 7 (LREAL 32)*, *Result Data Format 11 (DINT16 + LREAL 24)*

2-1-15 Communication Test

Here, check whether or not the EtherCAT communication settings are correct. In normal communication state, ECAT RUN LED on the Sensor Controller lights green.

If the communications are not properly performed, check the communication specification settings. As error events are registered in the troubleshooting of the Sysmac Studio, check them to solve the problem. For details, refer to *2-1-25 Sysmac Error Status* on page 2-67.



Additional Information

For LED specifications of ECAT RUN LED for the Sensor Controller, refer to *3-1 Sensor Controller* in the *Vision System FH series Hardware Setup Manual (Cat. No. Z366)* or *Smart Camera FHV series Setup Manual (Cat. No. Z408)*.

2-1-16 I/O Ports by Area (PDO Mapping) and Memory Allocation

This section describes each I/O port for the Command, Response, Data Output, User, and Sysmac Error Status Areas.

For the size, data type, initial value, and other information for each I/O port, refer to *Vision Sensor Specific Objects* in the *Manufacturer Specific Objects* on page 2-118.

I/O Ports for the Command Area

External device such as a PLC (Master) to Sensor Controller (Slave)

I/O port name	Signal name	Function
Control Flag	Control signal	
Command Request	Command Request	Switches from OFF to ON when the external device such as a PLC (master) instructs the Sensor Controller (slave) to process the control command. (Sets the control command code and parameters and then switches from OFF to ON.)
		Switches from ON to OFF by the external device such as a PLC (master) when the Sensor Controller (slave) turns ON the Command Completion signal.
Trigger	Measurement Trigger	Switches from OFF to ON when the external device such as a PLC (master) instructs the Sensor Controller (slave) to process the measurement execution.
		Switches from ON to OFF when the Trigger Acknowledged signal is turned ON.
Flow Command Request	Flow Command Request	Switches from OFF to ON when an entered command execution is instructed during the execution of the Fieldbus flow control.
		Switches from ON to OFF when the Flow Command Completion signal is turned ON
Error Clear	Clear Error	Switches from OFF to ON when the Error Status signal from the Sensor Controller (slave) is turned OFF.
		Switches from ON to OFF by the external device such as a PLC (master) when the Error Status signal is turned OFF.
Result Set Request	Data Output Request *1	Switches from OFF to ON when the external device such as a PLC (master) requests to output data. With this request, the Sensor Controller (slave) outputs the data.
		Switches from ON to OFF by the external device such as a PLC (master) when the Sensor Controller (slave) turns ON the Result Notification signal.
Command Code	Command Code	Stores the command code
Command Parameter 0 to 3	Command parameters	Stores the command parameters

*1. Valid only when the output handshaking is set to ON.



Precautions for Correct Use

Since Command Parameter 3 is the reserved area, it is unavailable. Use Command Parameter 0 to 2.

I/O Ports for the Response Area

Sensor Controller (Slave) to External device such as a PLC (Master)

I/O port name	Signal name	Function
Status Flag	Status signal	
Command Completion	Command Completion	Switches from OFF to ON when the Sensor Controller (slave) completes the control command execution and stores the control command code, response code, and response data. Automatically switches from ON to OFF when the external device such as a PLC (master) turns OFF the Command Request signal.
BUSY	Busy	Turns ON when the Sensor Controller (slave) cannot perform the control command. Turns OFF when the Sensor Controller (slave) can perform the control command.
Trigger Ready	Trigger Ready	Turns OFF when the Sensor Controller (slave) cannot perform the measurement trigger. Turns OFF when the image window is set to "Through". In this case, the measurements can be processed. Turns ON when the Sensor Controller (slave) can perform the measurement trigger.
Total Judgment	Overall Judgment Output	Turns ON when the overall judgment is NG. Turns OFF when the overall judgment is OK.
Run Mode	Run Mode	Turns ON when the Sensor Controller is in Run mode (In a measurement capable state with <i>RUN signal output</i> checked in the Layout settings for the currently displayed line). Turns OFF when the Sensor Controller (slave) is not in Run mode.
Trigger ACK	Trigger Acknowledged	Turns ON when the Sensor Controller receives the Trigger signal. Automatically turns OFF when the Trigger signal turns OFF.
Command Ready	Command Ready	Turns ON when the control command can be performed. Turns OFF when the control command cannot be performed.
Shutter Output	Shutter Trigger Output	After the exposure is completed, the signal turns ON after the time set in the Tool menu - System settings - Camera - Output Signal Setting - SHTOUT signal output additive time passed. The signal turns OFF after one cycle of the PDO communication cycle regardless of the time set in the SHTOUT width .
Flow Command Completion	Flow Command Completion	Turns ON after the echo back, response code, and response data for the executed command code are set during the execution for the Fieldbus flow control. Turns OFF after checking the Flow Command Request signal turned OFF.
Flow Command Busy	Flow Command Busy	Turns ON when an entered command is being executed during the execution of the Fieldbus flow control. Turns OFF after checking the Flow Command Request signal turned OFF.

I/O port name	Signal name	Function
Flow Command Wait	Flow Command Wait	Turns ON when a command can be entered during the execution of the Fieldbus flow control.
		Turns OFF when an executed command is completed.
Error Status	Error Signal	Turns ON if the Sensor Controller (slave) detects an error. For details, refer to <i>Error Messages and Troubleshooting</i> in the Vision System FH/FHV Series User's Manual (Cat. No. Z365).
		Turns OFF when the Sensor Controller (slave) runs normally.
Result Notification	Data Output Completion	Switches from OFF to ON when the Sensor Controller (slave) completes the data out.
		<ul style="list-style-type: none"> Without handshaking Turns OFF after the "Output Time" set in the EtherCAT settings has passed. With handshaking Automatically switches from ON to OFF when the external device such as a PLC (master) turns OFF the Result Set Request signal.
Command Code Echo Back	Command Code Echo Back	Returns the executed command code.
Response Code	Response Code	Stores the response code for the executed command.
Response Data	Response Data	Stores the response data for the executed command.
Error Code	Error Code	Stores the event code for the Sysmac error status when an error occurs. For the event codes, refer to <i>Sysmac Error Status Event Code Table</i> on page 2-67.

I/O ports for the Data Output Area

Sensor Controller (Slave) to External device such as a PLC (Master)

I/O port name	Signal name	Data output number	Function
DINT Result Data 0 to 63	Output data 0 to 63	1 (4 bytes) to 64 (256 bytes)	Outputs data with the pattern selected in the <i>Data Output Number</i> settings in the communication settings. Ex.: When the <i>Data Output Number</i> is set to 32byte DINT 2 + LREAL3, the I/O ports would be assigned as follows: DINT Result Data 0 DINT Result Data 1 LREAL Result Data 0 LREAL Result Data 1 LREAL Result Data 2
DINT Result Data 0 to 31		1 (8 bytes) to 32 (256 bytes)	

I/O Ports for the User Input Area

External device such as a PLC (Master) to Sensor Controller (Slave)

I/O port name	Signal name	Data type	Function
User Input Area 0	User Input Area 0	DINT	When the User Area is set to "ON" in the communication specification settings, this area can be used as an input area for the Sensor Controller that the user can write freely using the Macro Customization feature.
User Input Area 1	User Input Area 1	DINT	
User Input Area 2	User Input Area 2	DINT	
User Input Area 3	User Input Area 3	DINT	
User Input Area 4	User Input Area 4	LREAL	
User Input Area 5	User Input Area 5	LREAL	

I/O Ports for the User Output Area

Sensor Controller (Slave) to External device such as a PLC (Master)

I/O port name	Signal name	Data type	Function
User Output Area 0	User Output Area 0	DINT	When the User Area is set to "ON" in the communication specification settings, this area can be used as an output area for the Sensor Controller that the user can write freely using the Macro Customization feature.
User Output Area 1	User Output Area 1	DINT	
User Output Area 2	User Output Area 2	DINT	
User Output Area 3	User Output Area 3	DINT	
User Output Area 4	User Output Area 4	LREAL	
User Output Area 5	User Output Area 5	LREAL	

I/O Ports for Sysmac Error Status Area

The Sysmac Error Status is mapped only when the connecting destination is an NJ series Controller.

Use Sysmac Studio (standard edition) Ver. 1.09 or later.

Refer to *Checking Sysmac Error Status* on page 2-72.

Sensor Controller (Slave) to External device such as a PLC (Master)

I/O port name	Signal name	Function
Sysmac Error Status	Sysmac Error Status	Indicates the Sysmac error status.
Observation	Observation Error	Turns ON when an observation error occurs in the Sensor Controller (slave).
Minor Fault	Minor Fault Level Error	Turns ON when an minor fault level error occurs in the Sensor Controller (slave).

Rules for I/O Port Name

An I/O port name consists of the device name and line number to be controlled as shown below. When only one line is controlled, the line number is defined as "Line 0".

Example: Command Request Signal in the Command Area

E001_Line0_Command Request

- Device name

When the operation mode is Multi-line Random-trigger mode, the I/O ports for the Command Area, Response Area, and Data Output Area are allocated for each line. The I/O Ports for the Sysmac Error Status Area, however, are shared by all lines.

Line used	I/O port	
	Not Multi-line Random-trigger mode	Multi-line Random-trigger mode (Ex.: The number of lines is three.)
Line 0	E001_Line0_Command_Request	E001_Line0_Command_Request
Line 1	-	E001_Line0_Command_Request
Line 2	-	E001_Line0_Command_Request

Allocating Device Variables to I/O Ports (PDO Mapping)

When the Sensor Controller is connected to a CPU unit for NJ series, the data for the PDO communications in the Sensor Controller is displayed as the I/O port names on the Sysmac Studio.

To the I/O ports, allocate device variables on the Sysmac Studio I/O map to perform programming and monitoring.

Multiview Explorer (Connected to a NJ series CPU Unit): **Configurations and Setup - I/O Map** (Double-click)

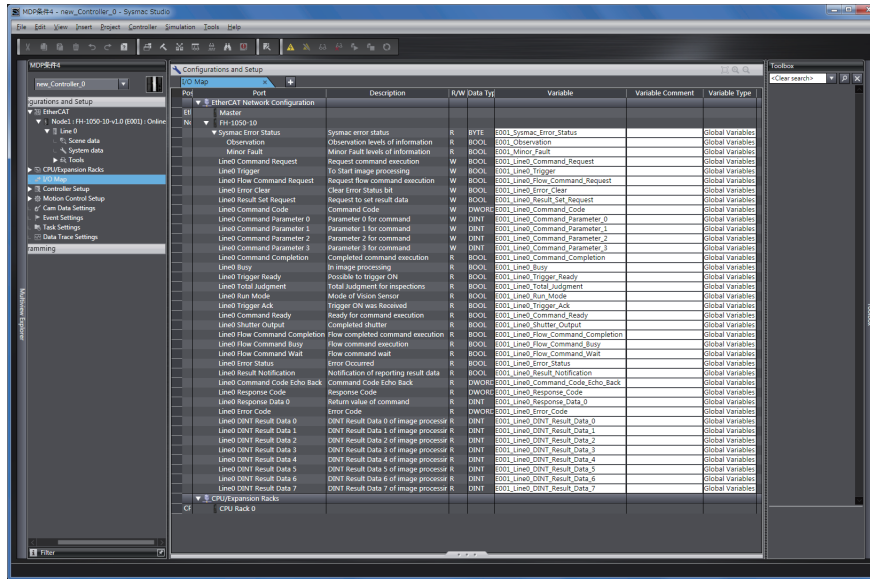

Select and right-click a slave or an I/O port on the I/O map, and select **Create Device Variable**. The device variable name is automatically created as a combination of the *device name* and *I/O port name*.

Or, select an I/O port and enter a variable name in the *Variable* column.

About the device name registration, there is another way like selecting a variable registered on the variable table instead of using the **Create Device Variable**. For details of the registering device variables, refer to the *Sysmac Studio Version 1 Operation Manual (Cat. No. W504)*.

2-1-17 I/O Signals

The following tables list the signals used to control I/O for EtherCAT.

Input Signals

Signal	Signal name	Function	ON/OFF timing	
			OFF to ON	ON to OFF
Command Request	Command Execution	This is turned on when the PLC will issue a command to the Sensor Controller.	This is turned on when the user (PLC) will issue a command (instruct the execution) to the Sensor Controller based on the command code and command parameters.	The user (PLC) switches from ON to OFF when the Command Completion signal from the Sensor Controller is turned ON.
Result Set Request (Used only for handshaking output control)	Data Output Request Signal	The user (PLC) issues this signal to the Sensor Controller to request to output the results performed in the measurement flow. When this signal is ON while an output unit (Fieldbus data output unit) in the measurement flow is performed, the Sensor Controller outputs the data of the processing item. When multiple output units output data with 256 bytes and more, turn ON the Result Set Request signal again after the Result Notification signal for the first data output turns OFF. For details, refer to <i>2-1-23 Timing Chart on page 2-61</i> .	<ul style="list-style-type: none"> The signal turns ON when the user (PLC) requests to output the data of the measurement results. *2 The Result Set Request signal is turned ON at the same time when the Trigger (measurement trigger) signal or the Command Request signal switches from OFF to ON. 	The user (PLC) switches from ON to OFF when the Result Notification signal from the Sensor Controller is turned ON. *1
Error Clear	Error Clear	This is turned on when the ERR signal from the Sensor Controller will be cleared.	The user (PLC) switches the signal from OFF to ON when the Error Status signal from the Sensor Controller is turned OFF.	The user (PLC) switches the signal from ON to OFF when it detects that the Error Status signal is turned OFF.

Signal	Signal name	Function	ON/OFF timing	
			OFF to ON	ON to OFF
Flow Command Request	Flow Command Request	This is turned on when a command will be performed while PLC Link, Fieldbus, or parallel flow control are performed.	The user (PLC) switches the signal from OFF to ON when it instructs an entered command execution during the execution of the Fieldbus flow control.	Switches from ON to OFF when the Flow Command Completion signal is turned ON
Trigger	Measurement Trigger	This is turned on when measurements will be performed.	The user (PLC) turns the signal ON to execute measurements after checking that the Trigger Ready signal is ON.	The user (PLC) switches the signal from ON to OFF when it detects that the Trigger Acknowledged signal is ON.

- *1. A timeout error will occur if the Result Set Request signal does not switch from ON to OFF within 10 seconds after the Result Notification signal turned ON.
In the case of EtherCAT, the data will not be discarded even though a timeout error occurred. Turn ON the Result Set Request signal after clearing the timeout error, the data when the timeout occurred is output.
- *2. A timeout error will occur if the Result Set Request signal does not switch from OFF to ON within the time set at the *Timeout* in the EtherCAT settings after the measurement processing starts by the Trigger (measurement trigger) signal or the Command Request signal turned ON.

Output Signals

Signal	Signal name	Function	ON/OFF timing	
			OFF to ON	ON to OFF
BUSY	Busy	This signal indicates that external inputs such as a command cannot be accepted. Be sure to issue commands under the condition which this signal is OFF.*1*2*4	The Sensor Controller turns the signal ON when it receives a command from the user (PLC). (After the Command Request signal switches from OFF to ON.)	The signal turns OFF when the a command execution is completed.
Command Completion	Command Completion	The Sensor Controller uses this signal to inform the PLC that command execution has been completed.	The signal turns ON when the Sensor Controller completes execution of a received command.	The signal automatically turns OFF when the user (PLC) switches the Command Request signal from ON to OFF.

Signal	Signal name	Function	ON/OFF timing	
			OFF to ON	ON to OFF
Result Notification	Data Output Completion	The signal informs the PLC of the timing to load output data. "ON" of this signal indicates that the Sensor Controller is outputting the data. The user (PLC) starts to load data when the signal turns ON.	<ul style="list-style-type: none"> Without handshaking The signal turns ON after the Sensor Controller performs the Output Unit (Fieldbus Data Output Unit) *1 in the measurement flow and is ready for the data output. With handshaking The signal turns ON after the Sensor Controller performs the Output Unit (Profibus Data Output Unit) *3 in the measurement flow and is ready for the data output and the Result Set Request signal is ON. 	<ul style="list-style-type: none"> Without handshaking The signal turns OFF after the <i>Output Time</i> set in the EtherCAT settings has passed. With handshaking The signal automatically turns OFF when the user (PLC) switches the Command Request signal from ON to OFF.
Error Status	Error Signal	The signal indicates that the Sensor Controller detects the following errors. For details, refer to <i>Error Messages and Troubleshooting</i> in the Vision System FH/FHV Series User's Manual (Cat. No. Z365).	The signal turns ON if the Sensor Controller detects an error. For details, refer to <i>Error Messages and Troubleshooting</i> in the Vision System FH/FHV Series User's Manual (Cat. No. Z365).	The signal turns OFF when the error is fixed and the user (PLC) turns the Error Clear signal ON.
Run Mode	Run Signal	The signal indicates that the Sensor Controller is in RUN mode.	The signal turns ON when the Sensor Controller is in Run mode (In a measurement capable state with RUN signal output checked in the Layout settings for the currently displayed line). (RUN LED lights.)	The signal turns OFF when the Sensor Controller cannot perform measurements and without RUN signal output checked in the Layout settings for the currently displayed line).
Total Judgment	Overall judgment	The signal indicates the overall judgment results.	The signal turns ON when the overall judgment is NG.	The signal turns OFF when the overall judgment is OK.
Trigger ACK	Trigger Acknowledged	The signal indicates that the Sensor Controller has accepted a Trigger signal.	The signal turns ON when the Sensor Controller receives the Trigger signal.	The signal turns OFF when the user (PLC) switches the Trigger signal from ON to OFF.
Command Ready	Command Execution Ready	The signal indicates that a control command is executable.	The signal turns ON when the control command can be performed.	The signal turns OFF when the control command cannot be performed.

Signal	Signal name	Function	ON/OFF timing	
			OFF to ON	ON to OFF
Trigger Ready	Trigger Input Ready	The signal indicates that the Cameras assigned to the Trigger signal can perform measurements. *5	The signal turns ON when the Cameras assigned to it can perform measurements. (I.e. When a Trigger signal can be input.)	The signal turns OFF when even one of the Cameras assigned to the Trigger signals cannot perform measurement (I.e. When a Trigger signal cannot be input.)
Shutter Output	Shutter Trigger Output	<p>The signal indicates the timing at which the imaging elements complete exposure.</p> <ul style="list-style-type: none"> When more than one Camera is connected, the signal turns ON to fit a Camera with the longest exposure time. The SHTOUT signal is unavailable when the image mode is set to "Through image". When more than one processing units related to the Camera Image Input is registered in the measurement flow, the SHTOUT signal turns ON for each processing unit. <p>In that case, use the <i>Camera Switching</i> processing item instead of processing units of the related to Camera Image Input processing items in the middle of the measurement flow.</p>	<p>After the exposure is completed, the signal turns ON after the time set in the Tool menu - System settings - Camera - Output Signal Setting - SHTOUT signal output additive time passed.</p> <p>For details of the SHTOUT signal output, refer to <i>Setting the Output Signal Specifications</i> on page 2-364.</p>	The signal turns OFF after one cycle of the PDO communication cycle regardless of the time set in the SHTOUT width .
Flow Command Completion	Flow Command Execution Completion	The signal indicates that a command performed while the Fieldbus flow control is being performed has been completed.	The signal turns ON after the echo back, response code, and response data for the executed command are set during the execution for the Fieldbus flow control.	The signal switches from ON to OFF when the Flow Command Request signal switches from ON to OFF during the execution for the Fieldbus flow control.

Signal	Signal name	Function	ON/OFF timing	
			OFF to ON	ON to OFF
Flow Command Busy	Flow Command Executing	The signal indicates that a command input during the execution for the Fieldbus flow control is in execution.	The signal switches from OFF to ON when a command input during the execution for the Fieldbus flow control is in execution.	The signal switches from OFF to ON when a command execution input during the execution for the Fieldbus flow control is completed.
Flow Command Wait	Flow Command Wait	The signal indicates that a command input can be accepted during the execution for the Fieldbus flow control.	The signal switches from OFF to ON when a command can be input during the execution for the Fieldbus flow control.	The signal switches from ON to OFF when the Flow Command Request signal switches from ON to OFF during the execution for the Fieldbus flow control.

- *1. Because the BUSY signal OFF time is short, the BUSY signal may appear to remain ON during continuous measurement, the Sensor Controller accepts the Command Request signal only when the End Continuous Measurement command is performed.
- *2. This will not be detected while commands received through any other protocol are processed.
(Ex.: This signal remains OFF during measurements with the Trigger signal in the Parallel communications.)
If you use more than one protocol and need to detect command execution, use the BUSY signal in Parallel.
- *3. This occurs at which the Output Unit is performed after the measurement flow is performed in order from the top. not the moment at which measurement execution was completed.
- *4. "ON" of this signal does not mean that a command is currently performed. To check whether a command is being executed, check the Command Completion (FLG) signal.
- *5. When you use a camera with lighting controller, based on its type and connecting conditions, the time required for the READY or Trigger Ready signal to turn OFF may increase in comparison with not using it. For details, refer to *Camera Image Input FH*, *Camera Image Input HDR* or *Camera Image Input FHV* in the *Vision System FH/FHV Processing Item Function Reference Manual (Cat. No. Z341)*.

2-1-18 Measurement Results for which Output is Possible (Fieldbus Data Output)

The following data can be output using the processing items related to the Result Output. Measurement values are also referred using processing units such as expressions.

Measurement items	Character string	Description
Judgment	JG	Judgment result
DINT data 0 to 63	DI00 to DI63	Results of expressions that are set for output data 0 to 63 in DINT (4-byte) format. The numerical values in the following range are output as an integer type by 1000 times. -2147483.648 to 2147483.647
LREAL data 0 to 31	DL00 to DL31	Results of expressions that are set for output data 0 to 31 in LREAL (8-byte) format. The numerical values in the following range are output as double precision floating point format. -999,999,999.9999 to 999,999,999.9999

External Reference Tables (Fieldbus Data Output)

By specifying a number, the following data can be referred using control commands or processing items having a set/get processing unit data function.

Number	Data name	Set/Get	Data range
0	Judgment	Get only	0: No judgment (unmeasured) 1: Judgment result OK -1: Judgment result NG
1,000 + 10*N (N = 0 to 63)	DINT data 0 to 63	Get only	-999,999,999.9999 to 999,999,999.9999 ^{*1}
2,000 + 10*N (N = 0 to 31)	LREAL data 0 to 31	Get only	-999,999,999.9999 to 999,999,999.9999 ^{*1}

*1. Since the response data area is DINT type, so the data is acquired as numerical values in the following range as an integer type by 1,000 times.
-2,147,483.648 to 2,147,483.647

2-1-19 Command List

This section describes the commands used in EtherCAT.



Additional Information

Use device variables assigned to the I/O port of the command area to specify command codes and command parameters of commands used in EtherCAT.

To specify a command code or command parameter for a device variable, refer to the following:
To specify a command code or command parameter for a device variable, refer to *A-1-2 Details of Commands Used in EtherCAT Communications* on page A-6

● Execution Commands

Command code for Command Area (hex)	Command name	Function	Reference
0010 1010	Single Measurement	Performs measurement one time.	page A-16
0010 1020	Start Continuous Measurements	Performs continuous measurement.	page A-16
0010 1030	End Continuous Measurements	Ends continuous measurements.	page A-17
0010 1040	Execute Unit Test	Performs test measurement for the specified unit.	page A-17
0010 2010	Clear Measurement Values	Clears all measurement result values.	page A-18
0010 2020	Clear Data Output Buffer	Clears the data output buffer.	page A-19
0010 2030	Clear I/O Output Memory	Clears the data output buffer and Output Area, and the value becomes 0 . Does not include User Area. Result_Notification turns ON to update the Output Area. Output control will be set to <i>None</i> .	page A-19
0010 2040	Clear Measurement State	Clears all measured values for the currently displayed scene. Clears the data output buffer and Output Area, and the value becomes 0 . Does not include User Area. Result_Notification turns ON to update the Output Area. Output control will be set to <i>None</i> .	page A-20
0010 3010	Save Data in Sensor Controller	Saves the current system data and scene group data in the Sensor Controller.	page A-20
0010 4010	Re-register Model	Registers the model again.	page A-21
0010 5010	Scroll	Shifts the image display position by the specified amount.	page A-22
0010 5020	Zoom	Zooms the image display in or out by the specified factor.	page A-23

Command code for Command Area (hex)	Command name	Function	Reference
0010 5030	Fit	Returns the display position and display magnification to their default values.	page A-24
0010 7010	Copy Scene Data	Copies the scene data.	page A-25
0010 7020	Delete Scene Data	Deletes the scene data.	page A-25
0010 7030	Move Scene Data	Moves the scene data.	page A-26
0010 8020	Load Registered Image	Loads the specified registered image as the measurement image.	page A-28
0010 9010	Echo	Returns an entered text string without changing it.	page A-28
0010 B010	Return to Start of Flow	Branches to the start of the measurement flow (processing unit 0).	page A-31
0010 F010	Restart	Restarts the Sensor Controller.	page A-31

● Commands to Get Status

Command code for Command Area (hex)	Command name	Function	Reference
0020 1000	Get Scene Number	Gets the current scene number.	page A-32
0020 2000	Get Scene Group Number	Gets the current scene group number.	page A-32
0020 4000	Get Layout Number	Gets the number of the layout that is currently displayed.	page A-33
0020 5010	Get Display Image Unit Number	Gets the number of the Unit that is currently displayed in the specified image display window.	page A-34
0020 5020	Get Display Sub-image Number	Gets the sub-image number that is currently displayed in the specified image display window.	page A-34
0020 5030	Get Image Display Status	Gets the image mode for the specified image display window.	page A-35
0020 7010	Get Communications Input Status	Gets the input status (prohibited/ permitted) for the Communications Modules.	page A-36
0020 7020	Get Communications Output Status	Gets the output status (prohibited/ permitted) to an external device.	page A-36
0020 8010	Get Parallel Terminal Status	Gets the ON/OFF status for the specified parallel I/O terminal.	page A-37
0020 8020	Get All Parallel Terminal Status	Gets the ON/OFF status of all parallel terminals except for DI terminals.	page A-39
0020 8030	Get All Parallel DI Terminal Status	Gets the ON/OFF status of all parallel DI terminals.	page A-41
0020 A000	Get Operation Log State	Gets the current state of the operation log.	page A-44

● Commands to Set Status

Command code for Command Area (hex)	Command name	Function	Reference
0030 1000	Switch Scene	Switches to the specified scene number.	page A-45
0030 2000	Switch Scene Group	Switches to the scene group with the specified number.	page A-45
0030 4000	Set Layout Number	Sets the layout number and switches the image.	page A-46
0030 5010	Set Display Image Unit Number	Sets the number of the Unit to display in the specified image display window.	page A-47
0030 5020	Set Display Sub-image Number	Sets the number of the sub-image to display in the specified image display window.	page A-47
0030 5030	Set Image Display Status	Sets the image mode for the specified image display window.	page A-48
0030 7010	Set Communications Input Status	Permits/prohibits inputs to the Communications Modules.	page A-49
0030 7020	Set Communications Output Status	Permits/prohibits outputs to external devices.	page A-49
0030 8010	Set Parallel Terminal Status	Sets the ON/OFF status of the specified parallel I/O terminal.	page A-50
0030 8020	Set All Parallel Terminal Status	Sets the ON/OFF status of all parallel terminals except for DO terminals.	page A-52
0030 8030	Set All Parallel DO Terminal Status	Sets the ON/OFF status of all parallel DO terminals.	page A-54
0030 A000	Set Operation Log State	Sets the state of the operation log.	page A-57

● Commands to Read Data

Command code for Command Area (hex)	Command name	Function	Reference
0040 1000	Get Unit Data	Gets the specified processing unit data.	page A-58
0040 4050	Get Data Logging Conditions	Gets the conditions set for data logging.	page A-64
0040 4060	Get Parallel Terminal Offset	Gets the parallel DI terminal offset data that is set.	page A-64

● Commands to Write Data

Command code for Command Area (hex)	Command name	Function	Reference
0050 1000	Set Unit Data	Sets the specified unit data.	page A-65
0050 4050	Set Data Logging Conditions	Sets the data logging conditions.	page A-70
0050 4060	Set Parallel Terminal Offset	Sets the parallel DI terminal offset data.	page A-71

2-1-20 Measurement Trigger Input

This section describes the ON/OFF timing for signals related to measurement trigger inputs using the following timing chart.

● Measurement Trigger Input Timing Chart

The Trigger signal is used to input a measurement trigger. Single measurement is performed each time the Trigger signal switches from OFF to ON.

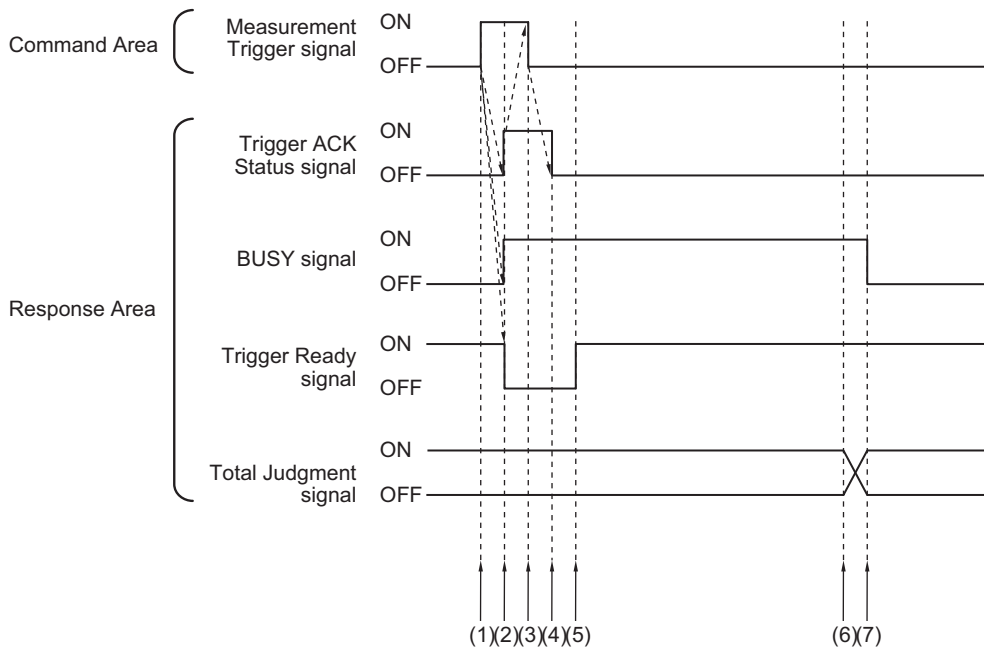

- (1) The external device such as a PLC (master) turns the Trigger signal ON after checking that the Trigger Ready signal is ON.
- (2) The Sensor Controller (slave) changes the status of the following signals.
 - Turns the BUSY signal ON.
 - Turns the Trigger Ack signal ON.
 - Turns the Trigger Ready signal OFF.
- (3) The external device such as a PLC (master) turns the Trigger signal OFF.
- (4) The Sensor Controller (slave) turns the Trigger Ack signal OFF.
- (5) The Sensor Controller (slave) turns the Trigger Ready signal ON when an image input has completed and the measurement trigger input becomes available.
- (6) When measurement processing is completed, the Sensor Controller (slave) turns the Total Judgment signal ON.
- (7) When measurement processing is completed, the Sensor Controller (slave) turns the Total BUSY signal OFF.

2-1-21 Command Response Processing

About control command response processing, the following timing chart describes the ON/OFF timing of signals related to commands to be input.

● Timing Chart for Command Execution

The Controller (master) uses the Command Request signal as a trigger to input and execute various commands such as measurement execution.

After a command was executed, turns the Command Request signal OFF when the Command Completion signal is turned ON.

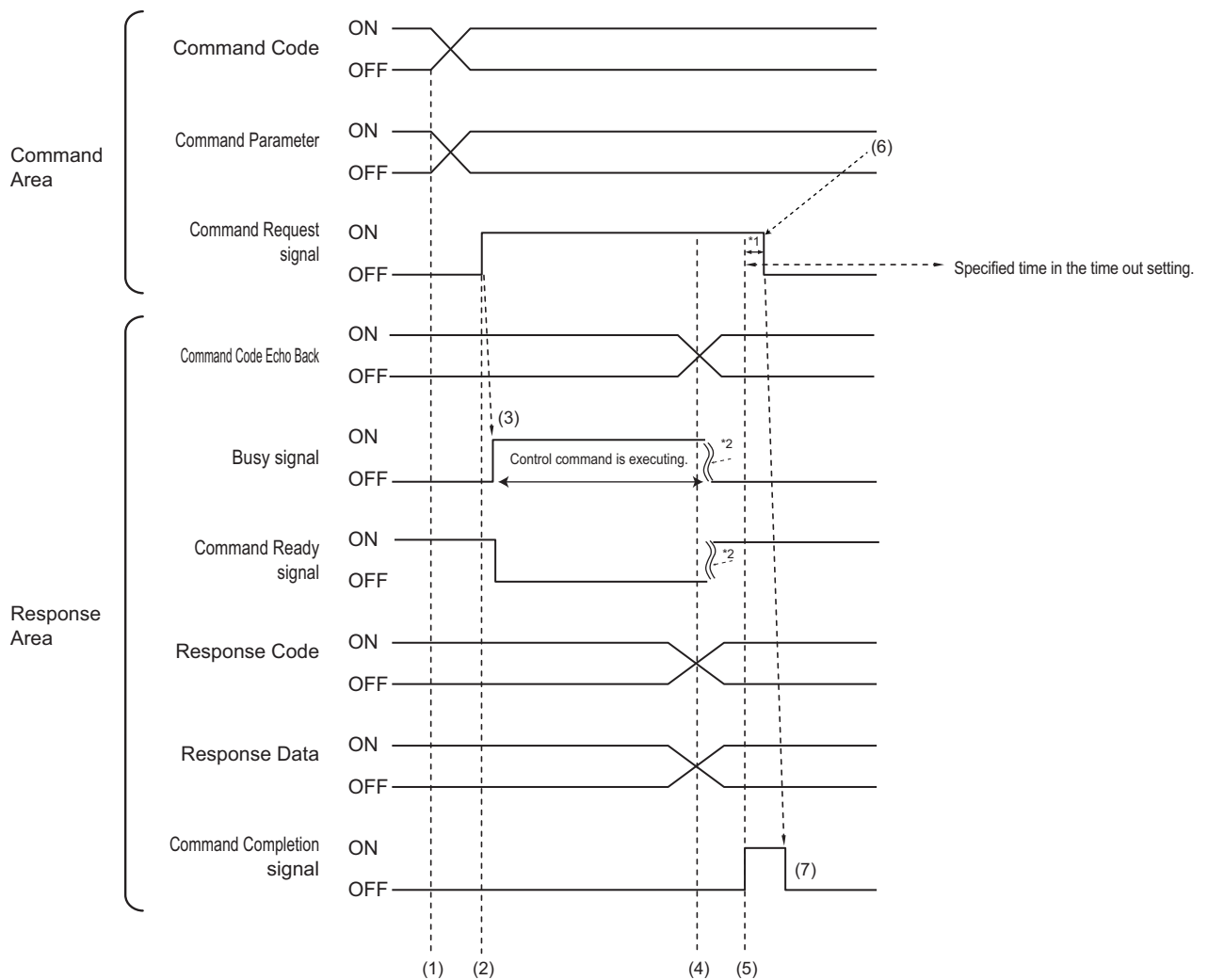

*1: A timeout error will occur if the Command Request signals does not turn OFF within 10 seconds. Then Command Completion signal and Busy signal will be forced to turn OFF.

*2: Busy signal are automatically switched from ON to OFF when command execution is completed.

- (1) The external device such as a PLC (master) sets the command code and command parameters.
- (2) After checking that the Command Ready signal is ON and the Command Completion signal is OFF, the external device such as a PLC (master) turns the Command Request signal ON.
- (3) The Sensor Controller (slave) turns the Busy signal ON
- (4) The Sensor Controller (slave) sets the echoing back the command code, response code, and response data.
- (5) The Sensor Controller (slave) turns the Command Completion signal ON.

- (6) The controller (master) turns the Command Request signal OFF.
- (7) The Sensor Controller (slave) turns the Command Completion signal OFF.

● **Continuous Measurement Command (Without handshaking)**

Continuous execution is used to repeatedly execute measurement by starting the next measurement operation (image input and measurement processing) as soon as single measurement operation (image input and measurement processing) is completed. Continuous measurement is started when the Start Continuous Measurements command is executed and ended when the End Continuous Measurements command is executed.

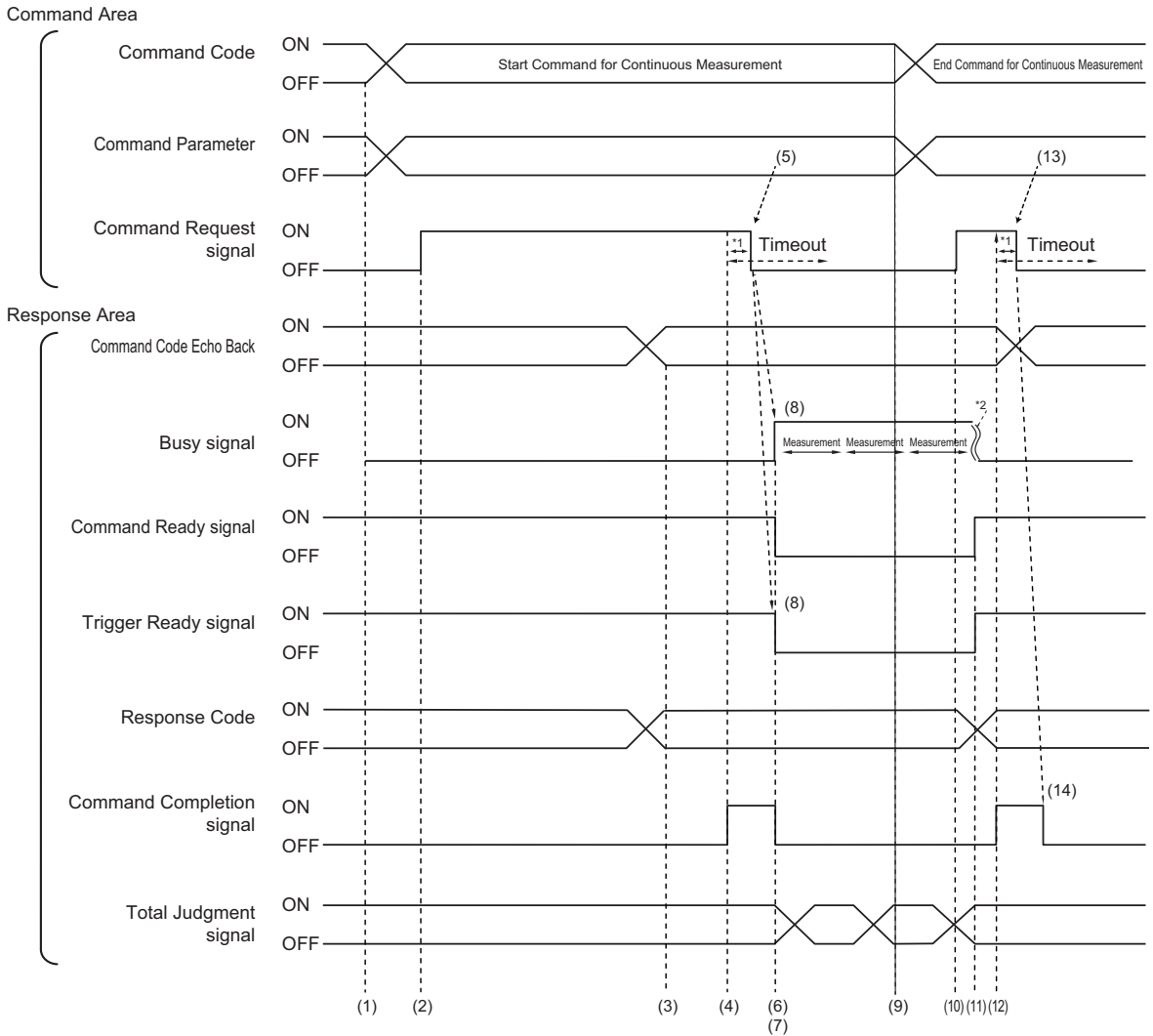

*1: A timeout error will occur if you turn off the Command Request signal within 10 seconds after the Command Completion signal is turned ON. Command Completion signal and Busy signal will be forcefully turned OFF.
 *2: Busy signal are automatically switched from ON to OFF when command execution is completed.

<Operation to Start Continuous Measurements>

- (1) The external device such as a PLC (master) sets the command code and command parameters.
- (2) After checking that the Command Ready signal is ON and the Command Completion signal is OFF, the external device such as a PLC (master) turns the Command Request signal ON.
- (3) The Sensor Controller (slave) sets the echoing back the command code, response code, and response data.

- (4) The Sensor Controller (slave) turns the Command Completion signal ON.
- (5) The controller (master) turns the Command Request signal OFF.
- (6) The Sensor Controller (slave) turns the Command Completion signal OFF.
- (7) The Sensor Controller (slave) starts continuous measurement.
- (8) The Sensor Controller (slave) turns the Busy signal ON and turns the Trigger Ready signal OFF.

<Operation to End Continuous Measurement>

- (9) The external device such as a PLC (master) sets the End Continuous Measurements command code during execution of continuous measurement by the Start Continuous Measurements command.
- (10) The external device such as a PLC (master) turns ON the Command Request (EXE) signal.



Additional Information

Continuous measurement is not ended in the middle of measurement. When the End Continuous Measurements command was executed, continuous measurement is ended after the measurement in execution was completed.

<Ending Continuous Measurement>

- (11) The Sensor Controller (slave) stops continuous measurement and turns OFF the BUSY signal.
- (12) After setting the command code echo back and response code, the Sensor Controller (slave) turns ON the Command Completion (FLG) signal.
- (13) The external device such as a PLC (master) turns OFF the Command Request (EXE) signal.
- (14) The Sensor Controller (slave) turns OFF the Command Completion (FLG) signal.



Precautions for Correct Use

- The measurement during continuous measurement is given priority. Therefore, display of the measurement results (total judgment, images, judgment for each processing unit in the flow display, and detailed results) may sometimes not be updated.
 - When continuous measurement is ended, the measurement results from the last measurement will be displayed.
-

2-1-22 Data Output

This section describes the ON/OFF timing for signals related to measurement data output after measurement completion using the following timing chart.

● Without handshaking

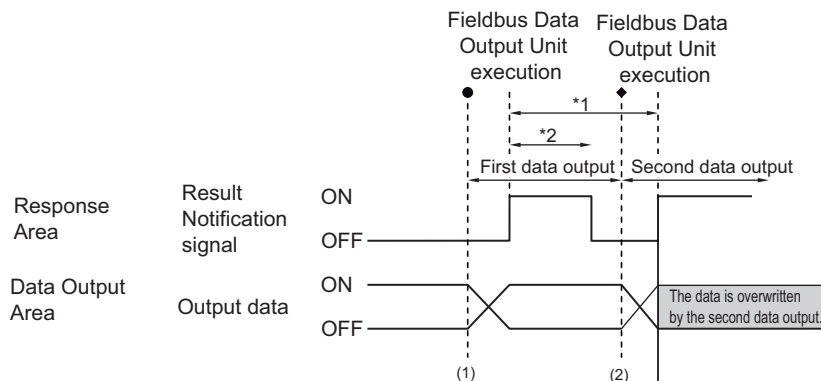

*1, *2: Data is output at the set output period*¹ and for the set output time.*² After data is output, the Result Notification signal is turned ON and the data is held for the data output time.

- (1) The Sensor Controller (slave) outputs data when the Fieldbus Data Output Unit starts execution.
- (2) Data is output each time that the Fieldbus Data Output Unit is performed for the second time or other Fieldbus Data Output Unit is performed. In that time, the output data for the first time is overwritten.



Precautions for Correct Use

Set the *Output period* in the communication settings to a time that is longer than the *Output time*.

● With handshaking

The Result Notification signal switches from OFF to ON when the external device such as a PLC (master) switches the Result Set Request signal from OFF to ON.

At that time, data that is possible to output will be output.*¹

The external device such as a PLC (master) checks that the Result Notification signal is ON and acquires the data, and then it needs to switch the Result Set Request signal from ON to OFF.

In the case where multiple Fieldbus Data Output Units perform the data output, the external device such as a PLC (master) needs to turn the Result Set Request signal ON again to instruct next data output when the Sensor Controller (slave) switched the Result Notification signal from ON to OFF.

*1: Data prepared for output which an Output Unit has been already performed in the measurement flow.

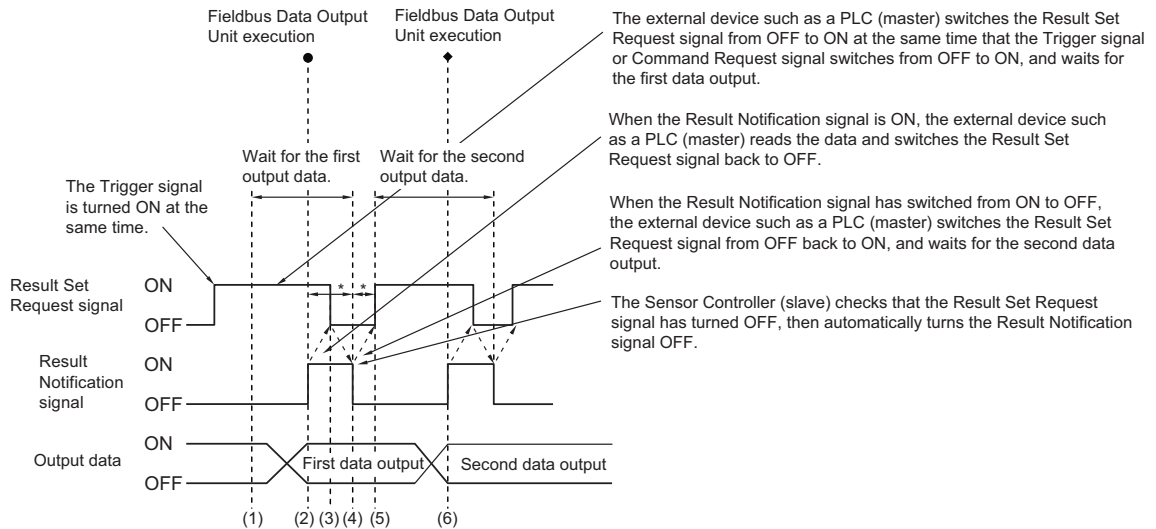

- *: A timeout error will occur if any of the following states continues for longer than the timeout time that is set in the EtherCAT settings.
- If the Result Set Request signal is not turned ON after a certain time elapses from when the Output Unit is executed. (Turn ON the Result Set Request at the same time as the measurement trigger input or the command input.)
 - If the Result Set Request signal is not turned OFF after a certain time elapses from when the Result Notification signal turned ON.

- (1) The external device such as a PLC (master) turns the Result Set Request signal ON.
 - (2) When the Fieldbus Data Output Unit in the measurement flow is performed, the Sensor Controller (slave) writes the data and then turns the Result Notification signal ON.
 - (3) The external device such as a PLC (master) acquires the data and then turns the Result Set Request signal OFF.
 - (4) The Sensor Controller (slave) turns the Result Notification signal OFF.
 - (5) In the case where multiple Fieldbus Data Output Units are placed in the measurement flow, the external device such as a PLC (master) turns the Result Set Request signal ON and then waits for the next Fieldbus Data Output Unit performed.
 - (6) When the next Fieldbus Data Output Unit is performed, the Sensor Controller (slave) writes the data and then turns the Result Notification signal ON.
- After that, repeat step 3 to 6.

2-1-23 Timing Chart

This section describes the ON/OFF timing for signals related to the sequence of operation from control command input until measurement data output after measurement completion using the following timing chart.

● Example 1: Inputting a Measurement Trigger after Switching a Scene without Handshaking

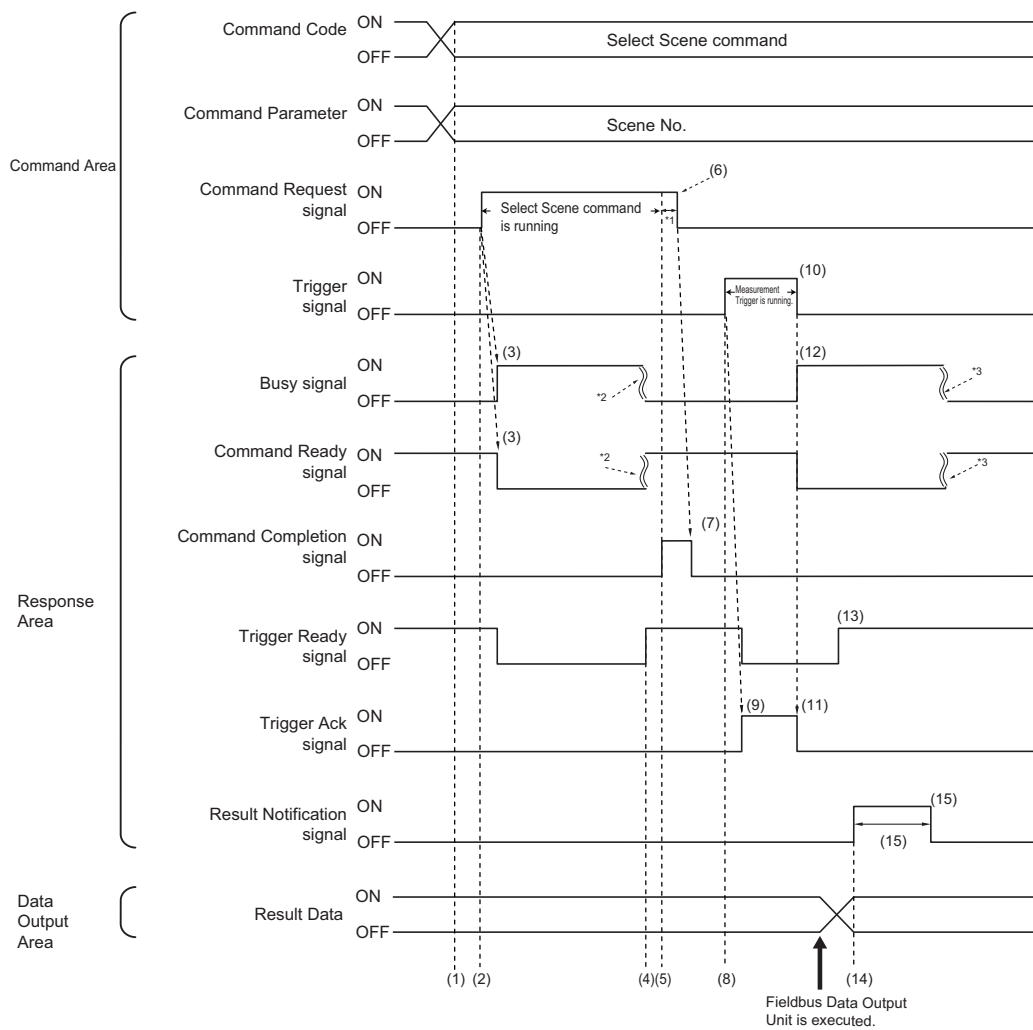

*1: A timeout error will occur if you turn off the Command Request signal from Sensor Controller (master) within the timeout period set in the EtherCAT settings. Then Command Completion signal and Busy (BUSY) signal will be forced to turn off.

*2: Busy (BUSY) signal is automatically switched ON from OFF when the command execution is completed.

*3: Busy (BUSY) signal is automatically switched ON from OFF when the measurement is completed.

- (1) The external device such as a PLC (master) sets the command code and command parameters for the scene switching command.
- (2) The external device such as a PLC (master) checks that the Command Ready signal is ON and the Command Completion signal is OFF, and then turns the Command Request signal ON.
- (3) The Sensor Controller (slave) turns the BUSY signal ON and the Command Ready signal OFF, and then switches the scene.
- (4) The Sensor Controller (slave) turns the Trigger Ready signal ON after the switching scene is completed.
- (5) The Sensor Controller (slave) turns the Command Completion signal ON.
- (6) The external device such as a PLC (master) turns the Result Set Request signal OFF.
- (7) The Sensor Controller (slave) turns the Command Completion signal OFF.

- (8) The external device such as a PLC (master) turns the Trigger signal ON.



Additional Information

Before inputting a measurement trigger after changing the scene, first check that the Command Completion signal that was turned ON by execution of the scene change command has turned OFF, and that the Trigger Ready signal is ON.

- (9) The Sensor Controller (slave) turns the Trigger Ack signal ON and the Trigger Ready signal OFF.
- (10) The external device such as a PLC (master) turns the Trigger signal OFF.
- (11) The Sensor Controller (slave) turns the Trigger Ack signal OFF.
- (12) the Sensor Controller (slave) turns the BUSY signal ON and performs measurement processing.
- (13) The Sensor Controller (slave) turns the Trigger Ready signal ON when image input processing has completed and the measurement trigger input becomes available.
- (14) When the Fieldbus Data Output Unit in the measurement flow is performed, the Sensor Controller (slave) writes the data and then turns the Result Notification signal ON.
- (15) After the time set at **Output time** in the EtherCAT settings passed, The Sensor Controller (slave) turns the Result Notification signal OFF.

● Example 2: Outputting Data with more than one Output Unit Without Hand-shaking

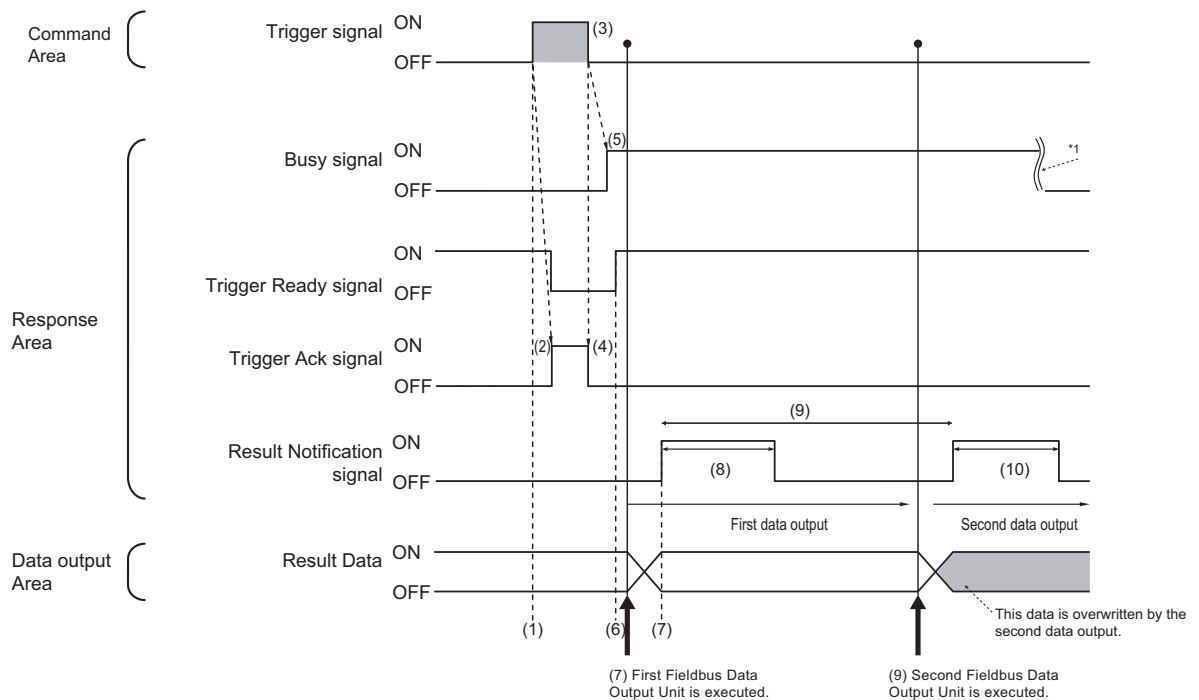

*1: Busy (BUSY) signal is automatically switched ON from OFF when the command execution is completed.

- (1) The external device such as a PLC (master) checks that the Trigger Ready signal is ON and then turns the Trigger signal ON
- (2) The Sensor Controller (slave) turns the Trigger Ack signal ON and the Trigger Ready signal OFF.
- (3) The external device such as a PLC (master) turns the Trigger signal OFF.
- (4) The Sensor Controller (slave) turns the Trigger Ack signal OFF.
- (5) the Sensor Controller (slave) turns the BUSY signal ON and performs measurement processing.
- (6) The Sensor Controller (slave) turns the Trigger Ready signal ON when image input processing has completed and the measurement trigger input becomes available.
- (7) When the first Fieldbus Data Output Unit in the measurement flow is performed, the Sensor Controller (slave) writes the data and then turns the Result Notification signal ON.
- (8) After the time set at **Output time** in the EtherCAT settings passed, The Sensor Controller (slave) turns the Result Notification signal OFF.
- (9) When the second Fieldbus Data Output Unit in the measurement flow is performed after the output cycle for the first one passed, the Sensor Controller (slave) turns the Result Notification signal ON.
- (10) After the time set at **Output time** in the EtherCAT settings passed, The Sensor Controller (slave) turns the Result Notification signal OFF.



Additional Information

Saving All of the Measurement Results

If you output data from more than one Data Output Unit or for repeatedly measured output data (e.g., for continuous measurements), the same Data Output Area will be overwritten.

To save all of the output data, adjust the *Output period* and *Output time* that are set in the EtherCAT settings so that all of the output data is output and either receive all of the output data by using the Result Notification signal or use handshaking control.

Handshaking lets you control data output by using the Result Notification signal turning ON as a trigger for the data output timing and turning ON the Result Set Request to read the output data.

Each time that data is output (from the second output on), read the output data and move it to a different part of I/O memory in the external device such as a PLC.

For more information on handshaking, refer to *Data Output Control with Handshaking* on page 1-24.

You can compare the received number of output data and the number of measurements for continuous measurements to check if all of the measurement results have been received.

Use the following method to check the number of measurements that was actually executed.

- Application Example

Set a calculation to count the number of measurements that are executed in the measurement flow.

If you set something like [DO+1], each time a measurement is executed (each time the measurement flow is executed), 1 will be added to DO, so the present value of DO will give you the actual number of measurements.

2-1-24 EtherCAT Troubleshooting

Cannot Communicate with the Sensor Controller

Problem	Cause	Action
Data is not input and output at all.	The node address is set incorrectly.	Check the node address setting switches.
	The devices are not connected correctly.	Check that the EtherCAT connectors (input and output) are connected to the devices correctly.
	The <i>Output Option</i> is not selected in the Adjustment window.	Place a check to the <i>Output Option</i> in the Adjustment window.
	The communication module settings are set incorrectly.	Check that EtherCAT is set in the communication module settings.
EtherCAT communications are unavailable due to <i>Slave Initialization Error (84230000 hex)</i> or Slave State Transition Failed (84300001 hex) .	PDO Mapping information (slot information for MDP) is different between the Sensor Controller and the Controller of the NJ/NX series.	Verify whether or not the following parameters are matched. <ul style="list-style-type: none"> • The number of controlled lines • Data output size • Use of User Area
	The Sysmac Studio does not support the FH Series version.	Check that the Sysmac Studio supports the FH Series version.
EtherCAT communications are unavailable due to <i>Slave Application Error (84280000 hex)</i> or Slave AL Status Error Detected (84360000 hex) .	The communication cycle for EtherCAT (PDO communication cycle time) has been set lower than the predetermined value.	The minimum communication cycle time (PDO communication cycle time) depends on the number of lines to control, the number of bytes for output data, use of the User Area, and use of Multi-line Random-trigger mode. For details, refer to <i>Minimum PDO Communication Cycle Time</i> on page 2-18.
	The Sysmac Studio does not support the FH Series version.	Check that the Sysmac Studio supports the FH Series version.

A Timeout Error Occurred

Problem	Cause	Action
A handshaking timeout error occurred.	<p>The Result Set Request signal is being turned ON and OFF too slowly.</p> <p>The following patterns are considered.</p> <ul style="list-style-type: none"> • The Result Set Request signal is not turned ON even measurement is completed. • The Result Set Request signal is not switched from ON to OFF even the Result Notification signal is turned ON. • The Result Set Request signal is not turned ON even the Result Notification signal is turned OFF. 	<p>After the measurement command is performed, turn the Result Set Request signal ON and OFF within the timeout time set in the EtherCAT communication settings.</p> <p>Or, increase the timeout time.</p>

Settings are not kept

Problem	Cause	Action
Settings such as Fieldbus Data Output Calculations or Comments are not kept.	Changed the communication settings after setting the Fieldbus Data Output.	Set the Fieldbus Data Output after performing the communication settings.



Additional Information

Errors that occur in the EtherCAT system, including sensor errors, are displayed as a Sysmac error status in Sysmac Studio(Standard Edition).
 For Sysmac Error Status, refer to *Sysmac Error Status Event Code Table* on page 2-67.

2-1-25 Sysmac Error Status

The Sysmac Studio (standard edition) displays errors occurred in the EtherCAT system (including errors in the sensor) as Sysmac error status.

Sysmac Error Status Event Code Table

This section describes the event codes for the Sysmac error status related to the Sensor. For details of the event code, refer to *NJ-series Troubleshooting Manual (Cat. No. W503)*.

• Levels:

Maj: major, Prt: Partial, Min: Minor, Minor, Obs: Observations, Info: Information

Event code	Event name	Description	Occurrence factor (Assumed cause)	Level ^{*1}					Ref.
				Maj	Prt	Min	Obs	Info	
0821 0000 hex	Fan/Power supply error	An error occurred in the fan or power supply.	<ul style="list-style-type: none"> There are obstacles disturbing the fan operation. An improper power supply is used, which cause over- or lower-voltage. 			○			page 2-74
0822 0000 hex	Camera overcurrent detected	An overcurrent state occurred on the Camera.	<ul style="list-style-type: none"> A short circuit occurs inside of the Camera cable or in the Controller circuit. 			○			page 2-74
0823 0000 hex	Parallel I/O overcurrent detected	An overcurrent state occurred in a Parallel I/O inter- face.	<ul style="list-style-type: none"> A Parallel I/O line is short-circuited. 			○			page 2-75
0825 0000 hex	Battery er- ror detected	An error occurred in the built-in bat- tery.	<ul style="list-style-type: none"> An error occurred in the built-in battery. 			○			page 2-75
182D 0000 hex	Setting data load error	Loading the scene group data failed.	<ul style="list-style-type: none"> The data is damaged because the power supply was turned off during the previous scene data save. As the result of changing its operation mode, the required memory amount increased causes insufficient memory. 			○			page 2-76

Event code	Event name	Description	Occurrence factor (Assumed cause)	Level*1					Ref.
				Maj	Prt	Min	Obs	Info	
385A 0000 hex	Change in connected camera	The camera con- nected is different from the previous one.	<ul style="list-style-type: none"> The Camera connection information in the scene data does not match the Camera currently connected to the Controller. 			○			page 2-76
3859 0000 hex	Camera connection error	Camera connec- tion error	<ul style="list-style-type: none"> A Camera is not connected to the Controller. The Camera cable is broken. The <i>Camera Selection</i> settings are incorrect in the <i>Camera Image Input</i> and <i>Camera Switching</i> processing units. A Camera is not connected to the Camera port on the Controller according to the <i>Camera Selection</i> settings in the <i>Camera Image Input</i> and <i>Camera Switching</i> processing units. 			○			page 2-77
4802 0000 hex	System er- ror	An error occurred in the system.	<ul style="list-style-type: none"> A serious error occurred in the system in the Controller. 			○			page 2-78

Event code	Event name	Description	Occurrence factor (Assumed cause)	Level ^{*1}					Ref.
				Maj	Prt	Min	Obs	Info	
5821 0000 hex	Output control timeout for Parallel I/O, PLC Link, EtherNet/IP, or PROFINET	A timeout occurred in the handshaking control of data output for measurement results.	<ul style="list-style-type: none"> The handshaking control of the data output in the program, i.e. ON/OFF timing for DSA signal, is improper. The timeout time for the output control is too short to the program processing time. The DSA signal or the Result Notification signal in the Parallel I/O is miswired. 			○			page 2-79
5822 0000 hex	Output control timeout (EtherCAT)	A timeout occurred in the handshaking control of data output for measurement results.	<ul style="list-style-type: none"> The handshaking control of the data output in the program, i.e. ON/OFF timing for DSA signal, is improper. The timeout time for the output control is too short to the program processing time. 			○			page 2-79
7819 0000 hex	Logging disk write error	Writing data to the logging disk failed.	<ul style="list-style-type: none"> A logging disk is not inserted. The free space on the logging disk is insufficient. There is no logging folder. Security restrictions are set on the logging disk. 			○			page 2-80

Event code	Event name	Description	Occurrence factor (Assumed cause)	Level*1					Ref.
				Maj	Prt	Min	Obs	Info	
781A 0000 hex	Setting data transfer error	An error occurred during the scene data transfer.	<ul style="list-style-type: none"> Scene data was edited when the free space on the RAMDisk was insufficient and the operation mode was Double Speed Multi-input mode. The <i>Data transfer</i> was clicked when the free space on the RAMDisk was insufficient and the operation mode was Non-stop Adjustment mode. 			○			page 2-81
781B 0000 hex	Output buffer error (EtherCAT)	The data output buffer for measurement results became full.	<ul style="list-style-type: none"> Measurements are performed in a cycle shorter than the time required for the handshaking control of the data output in the program. 			○			page 2-81
8808 0000 hex	PLC Link communications error	A PLC Link communications are not established.	<ul style="list-style-type: none"> The communication settings in the PLC or the Sensor Controller is improper. Cables for Ethernet or RS-232C are broken. 			○			page 2-82

Event code	Event name	Description	Occurrence factor (Assumed cause)	Level ^{*1}					Ref.
				Maj	Prt	Min	Obs	Info	
385B 0000 hex	Lighting connection configuration error	An error occurred in the lighting connection configuration.	<ul style="list-style-type: none"> The power consumption of the light connected to the Camera-mount lighting controller is improper. The light emitting mode of the light connected to the Camera-mount lighting controller is improper. Connects an external power supply to the Camera-mount lighting controller. 			○			page 2-82
5823 0000 hex	Incorrect Scene Group at Startup	The scene group is incorrect at startup.	<ul style="list-style-type: none"> The external storage set in the "Scene Group Saving Destination Settings" is not connected at startup. The directory for the scene group saving destination does not exist at startup. The scene group number at startup is out of range from the scene group specified in the system. 			○			page 2-83
5824 0000 hex	Incorrect Scene Number at Startup	The scene number is incorrect at startup.	<ul style="list-style-type: none"> The scene number at startup is set larger than the scene range specified in the system. 			○			page 2-84

*1. Level of Severity

- Major Fault Level:

These errors make the Controller be totally out of control. If a major error is detected, the execution of user programs is immediately stopped and loads for all slaves including remote I/Os are cut off.

You cannot clear major fault level errors through user programs, Sysmac Studio, or a PT of the NS series. To recover this situation, remove the cause of the error, and either turn the power supply for the Controller off and on or reset it using System Studio.

- **Partial Fault Level:**

These errors make a certain function module in the Controller be totally out of control. The Controller of the NJ series continues to perform user programs even after a partial error occurs. To recover from the situation, remove the cause of the error, and perform either one of the following.

- Reset the error through user programs, Sysmac Studio, or an PT of the NS series.
- Turn the power supply for the Controller off and on
- Reset the Controller through Sysmac Studio.

- **Minor Fault Level:**

These errors make a part of a certain function module in the Controller be out of control.

The troubleshooting for these errors is the same as the processing for the partial fault level errors.

- **Observations:**

These errors do not affect the Controller control.

Although these errors do not affect the control, the purpose of them is to warn users so that the errors do not develop into higher level errors.

- **Information:**

Notifications other than above errors.

Checking Sysmac Error Status

The Sysmac error status can be checked by the troubleshooting functions of the Sysmac Studio (standard edition). For details of the troubleshooting function, refer to *NJ/NX series Troubleshooting Manual (Cat. No. W503)*.

- 1** Select **Troubleshooting** from the **Tool** menu while online or click **Troubleshooting** in the toolbar.
The **Troubleshooting** dialog box is displayed.
- 2** Click the **Controller Errors** tab.
A list of the current Sysmac error status and corresponding event codes will be displayed.

Clearing Sysmac Error Status

- 1** Remove the cause of the error, then click **Reset All** on the **Controller Errors** tab page in the **Troubleshooting** dialog box.



Additional Information

Even if you reset the Sysmac error status, the error log will remain in the logs on the **Controller Event Log** tab.

Error Details

This section describes details on errors. The items used to describe individual errors (events) are described in the following copy of an error table.

Event name	Name of the error		Event code	Code of the error		
Description	Short description of the error					
Source	Source of the error		Source details	Details on the source of the error	Detection timing	When the error is detected.
Error attributes	Level	The level of influence on control ^{*1}	Recovery	Recovery method ^{*2}	Log category	Which log the error is saved in. ^{*3}
Effects	User program	What will happen to execution of the user program. ^{*4}	Operation	Special information on the operation at the error occurrence.		
LED	The status indicator for the EtherCAT port built into the NJ-series Controller. The indicator status is displayed only for errors in the EtherCAT Master Function Module and the EtherNet/IP Function Module.					
System-defined variables	Variable name		Data type		Name	
	Lists the variable names, data types, and names for system-defined variables that provide direct error notification, that are directly affected by the error, or that contain settings that cause the error.					
Cause and correction	Occurrence factor (Assumed cause)		Correction		Prevention	
	Lists the possible causes, corrections, and preventive measures for the error (event).					
Additional information	Additional information displayed by the Sysmac Studio or an PT of the NS series.					
Precautions/Remarks	Precautions, restrictions, and supplemental information					

*1. One of the following:

Major fault: Major fault level
 Partial fault: Partial fault level
 Minor fault: Minor fault level
 Observation
 Information

*2. One of the following:

Automatic recovery: Normal status is restored automatically when the cause of the error is removed.
 Error reset: Normal status is restored when the error is reset after the cause of the error is removed.
 Cycle the power supply: Normal status is restored when the power supply to the Controller is turned OFF and then back ON after the cause of the error is removed.
 Controller reset: Normal status is restored when the Controller is reset after the cause of the error is removed.
 Depends on cause: The recovery method depends on the cause of the error.

*3. One of the following:

System: System event log
 Access: Access event log

*4. One of the following:

Continues: Execution of the user program will continue.
 Stops: Execution of the user program stops.

Starts: Execution of the user program starts.

Error Descriptions

Event name	Fan/Power supply error			Event code	0821 0000 hex	
Description	An error occurred in the fan or power supply.					
Source	EtherCAT Master Function Module		Source details	Slave	Detection timing	Always at startup
Error attributes	Level	Minor Fault	Recovery	Error reset (after resetting the error in the slave)	Log category	System
Effects	User program	Continuous	Operation	All slave functionality stops until the problem is corrected.		
LED	EtherCAT NET RUN		EtherCAT NET ERR		EtherCAT LINK/ACT	
	-		-		-	
System-defined variables	Variable name		Data type		Name	
	None		-		-	
Cause and correction	Occurrence factor (Assumed cause)		Correction		Prevention	
	There are obstacles disturbing the fan operation.		Turn the power supply OFF, remove the obstacle disturbing the fan operation, and turn the power supply back ON.		Be sure to use it in conditions without obstacles disturbing the fan operation.	
	An improper power supply is used, which cause over- or lower-voltage.		Turn the power supply OFF and replace it with one with proper voltage, then turn it back ON.		Use a power supply with proper voltage.	
Additional information	None					
Precautions/Remarks	If the problem still exists after the corrections was performed, a hardware failure may have occurred. Consult your OMRON representative.					

Event name	Camera overcurrent detected			Event code	0822 0000 hex	
Description	An overcurrent state occurred on the Camera.					
Source	EtherCAT Master Function Module		Source details	Slave	Detection timing	Always at startup
Error attributes	Level	Minor Fault	Recovery	Error reset (after resetting the error in the slave)	Log category	System
Effects	User program	Continuous	Operation	The Camera image will not be input, so measurements will be performed on invalid images. This may result in the output of unintentional measurement results.		
LED	EtherCAT NET RUN		EtherCAT NET ERR		EtherCAT LINK/ACT	
	-		-		-	

System-defined variables	Variable name	Data type	Name
	None	-	-
Cause and correction	Occurrence factor (Assumed cause)	Correction	Prevention
	A short circuit occurs inside of the Camera cable or in the Controller circuit.	Consult your OMRON representative.	Consult your OMRON representative.
Additional information	None		
Precautions/Remarks	None		

Event name	Parallel I/O overcurrent detected		Event code	0823 0000 hex	
Description	An overcurrent state occurred in a Parallel I/O interface.				
Source	EtherCAT Master Function Module		Source details	Slave	Detection timing Always at startup
Error attributes	Level	Minor Fault	Recovery	Error reset (after resetting the error in the slave)	Log category System
Effects	User program	Continuous	Operation	Measurement results cannot be output to an external device with the parallel I/O.	
LED	EtherCAT NET RUN		EtherCAT NET ERR		EtherCAT LINK/ACT
	-		-		-
System-defined variables	Variable name	Data type	Name		
	None	-	-		
Cause and correction	Occurrence factor (Assumed cause)	Correction	Prevention		
	A Parallel I/O line is short-circuited.	Turn the power supply OFF and check the parallel I/O connections.	Route the parallel I/O lines so that they will not be short-circuited.		
Additional information	None				
Precautions/Remarks	None				

Event name	Battery error detected		Event code	0825 0000 hex	
Description	An error occurred in the built-in battery.				
Source	EtherCAT Master Function Module		Source details	Slave	Detection timing After the slave power was turned ON.
Error attributes	Level	Minor Fault	Recovery	Error reset (after resetting the error in the slave)	Log category System
Effects	User program	Continuous	Operation	Date-time setting of the Controller will be initialized.	

LED	EtherCAT NET RUN	EtherCAT NET ERR	EtherCAT LINK/ACT
	-	-	-
System-defined variables	Variable name	Data type	Name
	None	-	-
Cause and correction	Occurrence factor (Assumed cause)	Correction	Prevention
	An error occurred in the built-in battery.	Consult your OMRON representative.	Consult your OMRON representative.
Additional information	None		
Precautions/Remarks	None		

Event name	Setting data load error		Event code	182D 0000 hex		
Description	Loading the scene group data failed.					
Source	EtherCAT Master Function Module		Source details	Slave	Detection timing	After the slave power was turned ON.
Error attributes	Level	Minor Fault	Recovery	Error reset (after resetting the error in the slave)	Log category	System
Effects	User program	Continuous	Operation	The Controller will start with the default scene group data. If the data is saved into the Controller in this condition, the data currently saved will be overwritten.		
LED	EtherCAT NET RUN	EtherCAT NET ERR	EtherCAT LINK/ACT			
	-	-	-			
System-defined variables	Variable name	Data type	Name			
	None	-	-			
Cause and correction	Occurrence factor (Assumed cause)	Correction	Prevention			
	The data is damaged because the power supply was turned off during the previous scene data saved.	Set the scene you desired from scratch.	Do not turn the power supply OFF during saving the scene data.			
	As the result of changing its operation mode, the required memory amount increased causes insufficient memory.	Review the measurement flow so that the memory consumption is reduced.	Review the measurement flow so that the memory consumption is reduced.			
Additional information	None					
Precautions/Remarks	None					

Event name	Change in connected camera	Event code	385A 0000 hex
Description	The camera connected is different from the previous one.		

Source	EtherCAT Master Function Module		Source details	Slave	Detection timing	After the slave power was turned ON.
Error attributes	Level	Minor Fault	Recovery	Error reset (after resetting the error in the slave)	Log category	System
Effects	User program	Continuous	Operation	Although the Camera image input is available, the measurement may be performed by the number of camera pixels, color, and mono-chrome information unintended.		
LED	EtherCAT NET RUN		EtherCAT NET ERR		EtherCAT LINK/ACT	
	-		-		-	
System-defined variables	Variable name		Data type		Name	
	None		-		-	
Cause and correction	Occurrence factor (Assumed cause)		Correction		Prevention	
	The Camera connection information in the scene data does not match the Camera currently connected to the Controller.		Replace the Camera with one matched to the camera connection information held in the scene data or edit the scene data according to the information for the Camera connected to the Controller.		Be sure to match the Camera connection information in the scene data to the Camera connected to the Controller.	
Additional information	None					
Precautions/Remarks	The error will occur when system and scene group 0 data (bkd file) edited with simulation software is loaded to the Controller. Save the data once and then restart the Controller.					

Event name	Camera connection error			Event code	3859 0000 hex	
Description	The camera connection is wrong.					
Source	EtherCAT Master Function Module		Source details	Slave	Detection timing	Always at startup
Error attributes	Level	Minor Fault	Recovery	Error reset (after resetting the error in the slave)	Log category	System
Effects	User program	Continuous	Operation	The Camera image will not be input, so measurements will be performed on invalid images. This may result in the output of unintentional measurement results.		
LED	EtherCAT NET RUN		EtherCAT NET ERR		EtherCAT LINK/ACT	
	-		-		-	
System-defined variables	Variable name		Data type		Name	
	None		-		-	

Cause and correction	Occurrence factor (Assumed cause)	Correction	Prevention
	A Camera is not connected to the Controller.	Turn the power supply OFF, correctly connect a Camera to the Controller, and turn the power supply ON.	Correctly connect a Camera to the Controller and tighten the screws.
	The Camera cable is broken.	Turn the power supply OFF, replace the Camera cable with a new one, then turn it back ON.	Use a bending resistant cable or apply other measures so that the Camera cable will not be broken.
	The <i>Camera Selection</i> settings are incorrect in the <i>Camera Image Input</i> and <i>Camera Switching</i> processing units.	Properly perform the settings according to the connected Camera.	Properly configure the settings according to the connected Camera.
	A Camera is not connected to the Camera port on the Controller according to the <i>The Camera Selection</i> settings in the <i>Camera Image Input</i> and <i>Camera Switching</i> processing units.	Turn the power supply OFF, connect the Camera to the proper Camera port, and then turn it back ON.	Connect the Camera to the proper Camera port.
Additional information	None		
Precautions/Remarks	None		

Event name	System error		Event code	4802 0000 hex		
Description	An error occurred in the system.					
Source	EtherCAT Master Function Module		Source details	Slave	Detection timing	Always at startup
Error attributes	Level	Minor Fault	Recovery	Error reset (after resetting the error in the slave)	Log category	System
Effects	User program	Continuous	Operation	All functions in slaves stop, and measurement trigger signals and commands are not accepted.		
LED	EtherCAT NET RUN		EtherCAT NET ERR		EtherCAT LINK/ACT	
	-		-		-	
System-defined variables	Variable name		Data type		Name	
	None		-		-	
Cause and correction	Occurrence factor (Assumed cause)		Correction		Prevention	
	A serious error occurred in the system in the Controller.		Consult your OMRON representative.		Consult your OMRON representative.	
Additional information	None					
Precautions/Remarks	None					

Event name	Output control timeout for Parallel I/O, PLC Link, EtherNet/IP, or PROFINET		Event code	5821 0000 hex	
Description	A timeout occurred in the handshaking control of data output for measurement results.				
Source	EtherCAT Master Function Module		Source details	Slave	Detection timing At measurement result output
Error attributes	Level	Minor Fault	Recovery	Error reset (after resetting the error in the slave)	Log category System
Effects	User program	Continuous	Operation	The latest measurement data will be discarded.	
LED	EtherCAT NET RUN		EtherCAT NET ERR		EtherCAT LINK/ACT
	-		-		-
System-defined variables	Variable name		Data type		Name
	None		-		-
Cause and correction	Occurrence factor (Assumed cause)		Correction		Prevention
	The handshaking control of the data output in the program, i.e. ON/OFF timing for DSA signal, is improper.		Correct the program so that the handshaking control of the data output, i.e. ON/OFF timing for DSA signal, is proper.		Create the program so that the handshaking control of the data output, i.e. ON/OFF timing for DSA signal, is proper.
	The timeout time for the output control is too short to the program processing time.		Correct the timeout time according to the program processing time.		Set the timeout time according to the program processing time.
	The DSA signal or the Result Notification signal in the Parallel I/O is mis-wired.		Turn the power supply OFF, correctly route them, then restart it.		Correctly route them, then restart.
Additional information	None				
Precautions/Remarks	The error will occur when measurement results are output through the Parallel I/O, PLC Link, EtherNet/IP, or PROFINET. For EtherCAT, refer to the following <i>Output Control Timeout for EtherCAT</i> event.				

Event name	Output control timeout for EtherCAT		Event code	5822 0000 hex	
Description	A timeout occurred in the handshaking control of data output for measurement results.				
Source	EtherCAT Master Function Module		Source details	Slave	Detection timing At measurement result output
Error attributes	Level	Minor Fault	Recovery	Error reset (after resetting the error in the slave)	Log category System
Effects	User program	Continuous	Operation	Data is not output to the EtherCAT master and held in the Sensor Controller. The stored data will be output to the EtherCAT master when the Result Set Request signal is turned ON.	
LED	EtherCAT NET RUN		EtherCAT NET ERR		EtherCAT LINK/ACT
	-		-		-

System-defined variables	Variable name	Data type	Name
	None	-	-
Cause and correction	Occurrence factor (Assumed cause)	Correction	Prevention
	The handshaking control of the data output in the program, i.e. ON/OFF timing for DSA signal, is improper.	Correct the program so that the handshaking control of the data output, i.e. ON/OFF timing for DSA signal, is proper.	Create the program so that the handshaking control of the data output, i.e. ON/OFF timing for DSA signal, is proper.
	The timeout time for the output control is too short to the program processing time.	Correct the timeout time according to the program processing time.	Set the timeout time according to the program processing time.
Additional information	None		
Precautions/Remarks	The error will occur when measurement results are output through EtherCAT. For the Parallel I/O, PLC Link, EtherNet/IP, or PROFINET, refer to the above event, <i>Output Control Timeout for Parallel I/O, PLC Link, EtherNet/IP, or PROFINET</i> .		

Event name	Logging disk write error		Event code	7819 0000 hex	
Description	Writing data to the logging disk failed.				
Source	EtherCAT Master Function Module		Source details	Slave	Detection timing When logging images and Logging operations
Error attributes	Level	Minor Fault	Recovery	Error reset (after resetting the error in the slave)	Log category System
Effects	User program	Continuous	Operation	Logging failure continuously occurs until the problem is corrected.	
LED	EtherCAT NET RUN		EtherCAT NET ERR		EtherCAT LINK/ACT
	-		-		-
System-defined variables	Variable name	Data type	Name		
	None	-	-		
Cause and correction	Occurrence factor (Assumed cause)	Correction	Prevention		
	A logging disk is not inserted.	Insert the logging disk.	Insert the logging disk so that it will not come off.		
	The free space on the logging disk is insufficient.	Delete unnecessary files from the logging disk to increase the free space.	Delete unnecessary files from the logging disk to increase the free space.		
	There is no logging folder.	Create the logging folder or change it.	Create the logging folder or change it.		
	Security restrictions are set on the logging disk.	Clear the security restrictions on the logging disk.	Clear the security restrictions on the logging disk.		
Additional information	None				
Precautions/Remarks	The error will occur in image logging and operation logging and it will not occur in data logging.				

Event name	Setting data transfer error		Event code	781A 0000 hex	
Description	An error occurred during the scene data transfer.				
Source	EtherCAT Master Function Module		Source details	Slave	Detection timing After editing scene data
Error attributes	Level	Minor Fault	Recovery	Error reset (after resetting the error in the slave)	Log category System
Effects	User program	Continuous	Operation	Measurements will be performed without reflecting the edited scene data.	
LED	EtherCAT NET RUN		EtherCAT NET ERR		EtherCAT LINK/ACT
	-		-		-
System-defined variables	Variable name		Data type		Name
	None		-		-
Cause and correction	Occurrence factor (Assumed cause)		Correction		Prevention
	Scene data was edited when the free space on the RAM-Disk was insufficient and the operation mode was Double Speed Multi-input mode.		Clean the contents in the RAMDisk to increase the free space.		Normally be sure to keep the size for the current scene group data on the RAMDisk at least.
	The <i>Data transfer</i> was clicked when the free space on the RAMDisk was insufficient and the operation mode was Non-stop Adjustment mode.		Clean the contents in the RAMDisk to increase the free space.		Normally be sure to keep the size for the current scene group data on the RAMDisk at least.
Additional information	None				
Precautions/Remarks	The RAMDisk is used as a buffer when the operation mode is Double Speed Multi-input mode or Non-stop Adjustment mode. Normally be sure to keep the size for the current scene group data on the RAMDisk at least.				

Event name	Output buffer error (EtherCAT)		Event code	781B 0000 hex	
Description	The data output buffer for measurement results became full.				
Source	EtherCAT Master Function Module		Source details	Slave	Detection timing At measurement result output
Error attributes	Level	Minor Fault	Recovery	Error reset (after resetting the error in the slave)	Log category System
Effects	User program	Continuous	Operation	The latest measurement results data will be continuously discarded until sufficient free space is secured.	
LED	EtherCAT NET RUN		EtherCAT NET ERR		EtherCAT LINK/ACT
	-		-		-
System-defined variables	Variable name		Data type		Name
	None		-		-

Cause and correction	Occurrence factor (Assumed cause)	Correction	Prevention
	Measurements are performed in a cycle shorter than the time required for the handshaking control of the data output in the program.	Correct the program so that measurements are performed in a cycle longer than the time required for the handshaking control of the data output.	Create the program so that measurements are performed in a cycle longer than the time required for the handshaking control of the data output.
	None		
Precautions/Remarks	The buffer size for the EtherCAT measurement data is 4 KB. When the size for one Fieldbus Data Output Unit is 32 bytes (eight DINT formats), the buffer can store data up to 127 measurements.		

Event name	PLC Link communications error		Event code	8808 0000 hex		
Description	A PLC Link communications are not established.					
Source	EtherCAT Master Function Module		Source details	Slave	Detection timing	Always at startup
Error attributes	Level	Minor Fault	Recovery	Error reset (after resetting the error in the slave)	Log category	System
Effects	User program	Continuous	Operation	The Sensor Controller cannot be controlled via PLC Link.		
LED	EtherCAT NET RUN		EtherCAT NET ERR		EtherCAT LINK/ACT	
	-		-		-	
System-defined variables	Variable name		Data type		Name	
	None		-		-	
Cause and correction	Occurrence factor (Assumed cause)		Correction		Prevention	
	The communication settings in the PLC or the Sensor Controller is improper.		Correct the communication settings in the PLC and Sensor Controller.		Correct the communication settings in the PLC and Sensor Controller.	
	Cables for Ethernet or RS-232C are broken.		Replace the cable for Ethernet or RS-232C with a new one.		Use a bending resistant cable or apply other measures so that the cable will not be broken.	
Additional information	None					
Precautions/Remarks	The <i>PLC Link Connection Guide</i> is available on our website.					

Event name	Lighting connection configuration error		Event code	385B 0000 hex		
Description	An error occurred in the lighting connection configuration.					
Source	EtherCAT Master Function Module		Source details	Slave	Detection timing	After the slave power was turned ON.
Error attributes	Level	Minor Fault	Recovery	Error reset (after resetting the error in the slave)	Log category	System

Effects	User program	Continuous	Operation	The lighting does not turn on.	
LED	EtherCAT NET RUN		EtherCAT NET ERR		EtherCAT LINK/ACT
	-		-		-
System-defined variables	Variable name		Data type		Name
	None		-		-
Cause and correction	Occurrence factor (Assumed cause)		Correction		Prevention
	The power consumption of the light connected to the Camera-mount lighting controller is improper.		Connect a lighting with proper power consumption to the Camera-mount lighting controller.		Consult the instruction manual for the lighting, and check the power consumption of it is proper for the Camera-mount lighting controller.
	The light emitting mode of the lighting connected to the Camera-mount lighting controller is improper.		Properly set the light emitting mode for the lighting connected to the Camera-mount lighting controller.		Consult the <i>FH/FHV Series Vision System Processing Item Function Reference Manual (CAT. No. Z341)</i> , and check the proper lighting mode for the lighting.
	No external power supply is connected to the Camera-mount lighting controller.		Connects an external power supply to the Camera-mount lighting controller.		Check that the cable of an external power supply is connected to the Camera-mount lighting controller.
Additional information	None				
Precautions/Remarks	None				

Event name	Incorrect Scene Group at Startup		Event code	5823 0000 hex	
Description	The scene group is incorrect at startup.				
Source	EtherCAT Master Function Module		Source details	Slave	Detection timing After the slave power was turned ON.
Error attributes	Level	Minor Fault	Recovery	Error reset (after resetting the error in the slave)	Log category System
Effects	User program	Continuous	Operation	All functions in slave stop until the problem is corrected.	
LED	EtherCAT NET RUN		EtherCAT NET ERR		EtherCAT LINK/ACT
	-		-		-
System-defined variables	Variable name		Data type		Name
	None		-		-

Cause and correction	Occurrence factor (Assumed cause)	Correction	Prevention
	The external storage set in the "Scene Group Saving Destination Settings" is not connected at startup.	Connect the external storage set in the "Scene Group Saving Destination Settings".	Check that the cable of an external power supply is connected to the Camera-mount lighting controller, and restart the Sensor Controller.
	The directory for the scene group saving destination does not exist at startup.	Select another directory in the connected external storage at the scene group saving destination in the "Scene Group Saving Destination Settings" dialog.	Use the external storage which has the directory specified as the scene group saving destination.
	The scene group number at startup is out of range from the scene group specified in the system.	Correct the scene group number at startup, save it, and restart the Sensor Controller.	Check that the scene group number at startup is correct, save it, and restart the Sensor Controller.
Additional information	None		
Precautions/Remarks	None		

Event name	Incorrect Scene Number at Startup		Event code	5824 0000 hex		
Description	The scene number is incorrect at startup.					
Source	EtherCAT Master Function Module		Source details	Slave	Detection timing	After the slave power was turned ON.
Error attributes	Level	Minor Fault	Recovery	Error reset (after resetting the error in the slave)	Log category	System
Effects	User program	Continuous	Operation	All functions in slave stop until the problem is corrected.		
LED	EtherCAT NET RUN		EtherCAT NET ERR		EtherCAT LINK/ACT	
	-		-		-	
System-defined variables	Variable name		Data type		Name	
	None		-		-	
Cause and correction	Occurrence factor (Assumed cause)		Correction		Prevention	
	The scene number at startup is set larger than the scene range specified in the system.		Correct the scene number at startup, save it, and restart the Sensor Controller.		Check that the scene number at startup is correct, save it, and restart the Sensor Controller.	
Additional information	None					
Precautions/Remarks	None					

2-1-26 Sysmac Device Features

Sysmac Devices are the control device products designed based on standardized communications and user interface specifications for OMRON control devices.

And the features available with them are so called “Sysmac Device Features”.

This section describes the features when they are combined with a Machine Automation Controller such as NJ series, and with automation software.

Sysmac Error Status

Since errors occurring in slaves are systematized in Sysmac Devices, you can check the causes and measures for errors with common procedures using Sysmac Studio.

The status of an error can be monitored at the Sysmac Error Status (2002 hex - 01 hex). To display the error status detected by the Sensor Controller for the FH/FHV/FZ5 series to Sysmac Studio, map the Sysmac Error Status (2002 hex - 01 hex) to the PDO. Sysmac Studio, by default, uses 1BFF hex: 512th transmit PDO mapping assignment to map Sysmac Error Status (2002 hex - 01 hex) automatically to the PDO.



Additional Information

- For the Sysmac Error status (2002 hex - 01 hex), refer to *2-1-27 Object Dictionary* on page 2-88.
- For errors displayed in Sysmac Studio, refer to *NJ/NX series Troubleshooting Manual (Cat. No. W503)*.

Saving Node Address Settings

When the node address switch is set to 00, it means Software Setup mode, the node address setting value set in Sysmac Studio is enabled. When it is other than 00, The value of the node address switch is used as the node address.

In the Software Setup Mode, perform *Write Slave Node Address* on the *EtherCAT Edit* in Sysmac Studio, save the slave node address setting in the nonvolatile memory in the Sensor Controller.

• Software Settings

The setting value saved as Slave Information Interface (SII) in the nonvolatile memory in the slave is the node address.

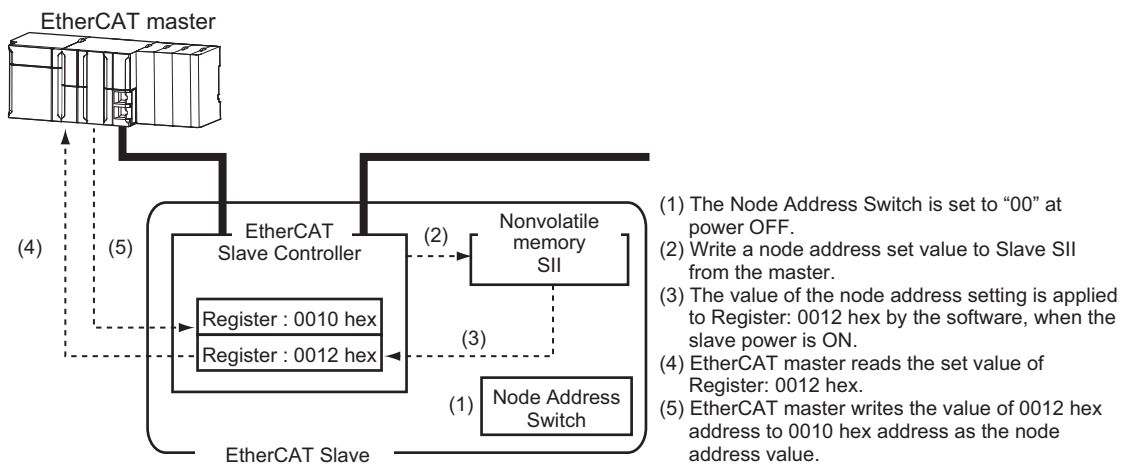

• Node Address Switch Setting

The value set to the node address switch is the node address.

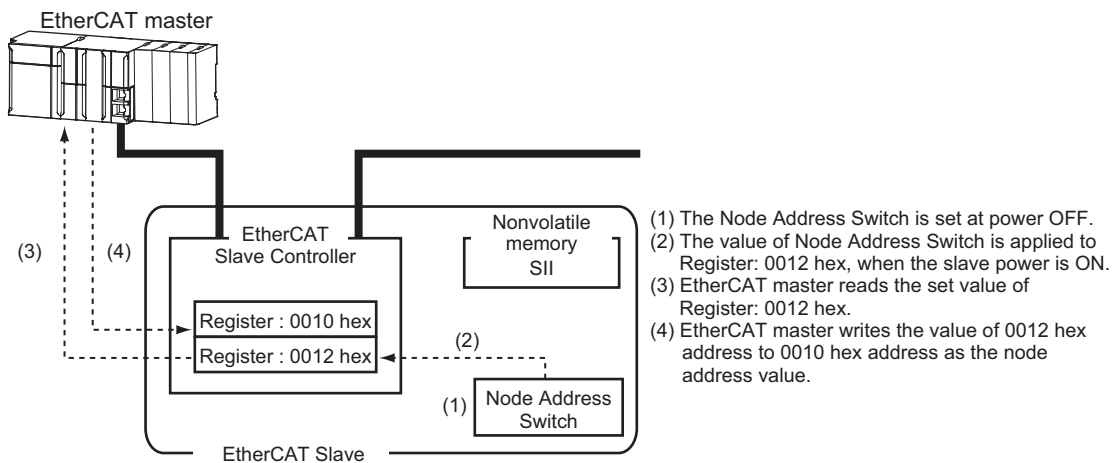

Serial Number Display

The serial number saved in the non-volatile memory in the Sensor Controller is displayed at 1018 hex - 04 hex: Serial Number.

Controllers supporting Sysmac Device Features use this serial number to grasp the network configuration.

When grasping it, set **Serial No. Check Condition** to **Set Value = Actual Unit** on **EtherCAT Edit** screen in Sysmac Studio.

If the specified condition is not satisfied, "Network Configuration Check Error" will occur.



Additional Information

The network configuration check detects any slave devices that have been replaced, which prevents you from forgetting to set parameters on those slaves.

Compliance with ESI Specification (ETG. 2000 S (R) V1.0.1)

The ESI specifications are a set of specifications defining the entries required in an EtherCAT Slave Information (ESI) file.

SII Data Check

The Slave Information Interface (SII) is an interface area in the non-volatile memory of an EtherCAT slave in which the configuration information for the EtherCAT slave is stored.

EtherCAT slaves as Sysmac Device check the SII information.

If SII information, which slaves cannot accepted, was written here, an SII Check Error (Error No. 88.3) occurs.

If the problem still exists even after it is restarted, contact your OMRON sales representative.



Precautions for Correct Use

Do not use third-party or any other configuration tools to edit the SII information.

2-1-27 Object Dictionary

The CAN application protocol over EtherCAT (CoE) protocol is based on the object dictionary of the CAN application protocol. This section describes the object dictionary and each object.

Object Dictionary Area

Each object is allocated with an index of four-digit hexadecimal value, and the indexes are configured in the area below.

Indexes	Areas	Description
0000 hex to 0FFF hex	Data Type area	Definitions of data types
1000 hex to 1FFF hex	CoE Communication area	Definitions for variables that can be applied to all servers for a dedicated communication.
2000 hex to 2FFF hex	Manufacture Specific area 1	Variables defined for all OMRON products.
3000 hex to 5FFF hex	Manufacture Specific area 2	Variables defined for EtherCAT Slave Units of the FH/FHV series. Command/response method using message communication (SDO)
6000 hex to 6FFF hex	Input area	Objects mapped to TxPDO
7000 hex to 7FFF hex	Output area	Objects mapped to RxPDO
8000 hex to 8FFF hex	Configuration area	Objects for configurations and settings
8000 hex to 8FFF hex	Information area	Not used (Unsupported)
A000 hex to AFFF hex	Diagnosis area	Not used (Unsupported)
B000 hex to BFFF hex	Send Service area	Not used (Unsupported)
C000 hex to EFFF hex	Reserved area	Area reserved for future use
F000 hex to FFFF hex	Device Profile area	Parameters belonging to devices

● Data types

This profile uses the data types below.

Data types	Code	Size	Range
Boolean	BOOL	1 bit	true(1), false(0)
Unsigned8	U8	1 bytes	0 to 255
Unsigned16	U16	2 bytes	0 to 65,535
Unsigned32	U32	4 bytes	0 to 4,294,967,295
Integer8	INT8	1 byte	-128 to 127
Integer16	INT16	2 bytes	-32,768 to 32,767
Integer32	INT32	4 bytes	-2,147,483,648 to 2,147,483,647
Visible string	VS	-	-
Double	Double	8 bytes	-1.79769313486231e+308 to 1.79769313486231e + 308

Object Description Format

Here, describes objects by the following format.

• Object Description Format

<Index>	<Object name>		
Range: <Setting range>	Unit: <Unit>	Default: <Default setting>	Attribute: <Data attribute>
Size: <Size>	Access: <Access>	PDO map: <Possible/Not possible>	

• Object Description Format with Sub-indexes

<Index>	<Object name>		
Sub-index 0			
Range: <Setting range>	Unit: <Unit>	Default: <Default setting>	Attribute: <Data attribute>
Size: <Size>	Access: <Access>	PDO map: <Possible/Not possible>	
:			
:			
Sub-index N			
Range: <Setting range>	Unit: <Unit>	Default: <Default setting>	Attribute: <Data attribute>
Size: <Size>	Access: <Access>	PDO map: <Possible/Not possible>	

The following values are indicated within the pointed brackets <>.

Indexes	:	An object index given by a four-digit hexadecimal number.
Object name	:	Object name
Range	:	Range for settable numerical value
Unit	:	Physical unit
Default	:	Default value set at product shipment
Attribute	:	Timing at which changes are enabled in a writable object. A: Always enabled B: Timing of transition from count stop to operation (Encoder Input Slave Unit only) C: Timing of transition from pre-operational state to safe-operational state D: Timing of transition from pre-operational state to initial value state R: Updated after the power supply is reset. - : Read only
Size	:	The object size in bytes
Access	:	Indicates whether the object is read-only or readable and writable. RO: Read-only RW: Readable and writable
PDO map	:	Indicates the PDO mapping availability.

Communication Objects

1000 hex	Device Type		
Range: -	Unit: -	Default: 00000000 hex	Attribute: -
Size: 4 bytes (U32)		Access: RO	PDO map: Not possible

- The Sensor Controllers of the FH/FHV series do not support a device profile.

1001 hex	Error Register		
Range: -	Unit: -	Default: 00 hex	Attribute: -
Size: 1 byte (U8)		Access: RO	PDO map: Not possible

- The table below indicates the error types occurring in a Slave Unit.

Bit	Name	Bit	Name
0	General error	4	Communication error
1	Current error	5	Device profile specific error
2	Voltage error	6	(Reserved)
3	Temperature error	7	Manufacture specific error

1008 hex	Manufacturer Device Name		
Range: -	Unit: -	Default: by Slave Unit type *1	Attribute: -
Size: 20 bytes (VS)		Access: RO	PDO map: Not possible

- Indicates the Slave Unit model number.

1009 hex	Manufacturer Hardware Version		
Range: -	Unit: -	Default: by Slave Unit type *1	Attribute: -
Size: 20 bytes (VS)		Access: RO	PDO map: Not possible

- Indicates the version of the Slave Unit hardware.

100A hex	Manufacturer Software Version		
Range: -	Unit: -	Default: by Slave Unit type *1	Attribute: -
Size: 20 bytes (VS)		Access: RO	PDO map: Not possible

- Indicates the version of the Slave Unit software.

*1: The default settings for the manufacture device name, manufacture hardware version, and manufacture software version are shown below for each slave.

Slave/ Manufacture device name	Manufacture hardware version	Manufacture software version
FH-2050	V1.00	V6.XX
FH-2050-10	Space (20 hex) × 15 characters	(The Senxor Contoroller software
FH-2050-20	(Fifteen space characters are in-	version, *1 which consists of nine-
FH-5050	serted after the hardware version	teen characters, follows after letter
FH-5050-10	V1.00.)	V. When the length of the software
FH-5050-20		version string is less than nineteen
FH-5550		characters, spaces (20 hex) are fil-
FH-5550-10		led until the version string length
FH-5550-20		becomes nineteen.)
FH-2052		
FH-2052-10		
FH-2052-20		
FH-5052		
FH-5052-10		
FH-5052-20		
FH-5552		
FH-5552-10		
FH-5552-20		
FH-2051		
FH-2051-10		
FH-2051-20		
FH-5051		
FH-5051-10		
FH-5051-20		
FH-5551		
FH-5551-10		
FH-5551-20		
FHV7H-M004+SDU30		
FHV7H-C004+SDU30		
FHV7H-M016+SDU30		
FHV7H-C016+SDU30		
FHV7H-M032+SDU30		
FHV7H-C032+SDU30		
FHV7H-M050+SDU30		
FHV7H-C050+SDU30		
FHV7H-M063R+SDU30		
FHV7H-C063R+SDU30		
FHV7H-M120R+SDU30		
FHV7H-C120R+SDU30		
FHV7X-M004+SDU30		
FHV7X-C004+SDU30		
FHV7X-M016+SDU30		
FHV7X-C016+SDU30		
FHV7X-M032+SDU30		
FHV7X-C032+SDU30		
FHV7X-M050+SDU30		
FHV7X-C050+SDU30		
FHV7X-M063R+SDU30		
FHV7X-C063R+SDU30		
FHV7X-M120R+SDU30		
FHV7X-C120R+SDU30		

*1. The software version refers to the version displayed in the *System information* dialog.

1011 hex	Restore Default Parameters		
Sub-index 0: Number of entries			
Range: -	Unit: -	Default: 01 hex	Attribute: -
Size: 1 byte (U8)	Access: RO		PDO map: Not possible
Sub-index 1: Restore Default Parameters			
Range: -	Unit: -	Default: 00000001 hex	Attribute: A
Size: 4 bytes (U32)	Access: RW		PDO map: Not possible

- Resets the parameters to their default values.
- To avoid accidentally overwriting, the parameters are reset only when a specific value is written to sub-index 1.
- The specific value is *load*.

MSB		LSB	
d	a	o	l
64 hex	61 hex	6F hex	6C hex

- The ABORT code is displayed if a value other than the specific one is written.
- A value 0000 0001 hex (command valid) is indicated in reading.
- The Sensor Controllers of the FH/FHV series do not support this parameter.

1018 hex	Identity Object		
Sub-index 0: Number of entries			
Range: -	Unit: -	Default: 04 hex	Attribute: -
Size: 1 byte (U8)	Access: RO		PDO map: Not possible
Sub-index 1: Vendor ID			
Range: -	Unit: -	Default: 00000083 hex	Attribute: -
Size: 4 bytes (U32)	Access: RO		PDO map: Not possible
Sub-index 2: Product Code			
Range: -	Unit: -	Default: by Slave Unit type *1	Attribute: -
Size: 4 bytes (U32)	Access: RO		PDO map: Not possible
Sub-index 3: Revision Number			
Range: -	Unit: -	Default: by Slave Unit type *1	Attribute: -
Size: 4 bytes (U32)	Access: RO		PDO map: Not possible
Sub-index 4: Serial Number			
Range: -	Unit: -	Default: Each Unit	Attribute: -
Size: 4 bytes (U32)	Access: RO		PDO map: Not possible

- Indicates the device information.
- Sub-index 1 (Vendor ID) indicates the manufacturer identifier.
- Sub-index 2 (Product Code) indicates the value assigned to each Slave Unit type.
- Sub-index 3 (Revision Number) indicates the Unit revision number.
- Bit 0 to 15: Minor revision number of the device
- Bit 16 to 31: Major revision number of the device
- Sub-index 4 (Serial Number) indicates a serial number for each product.

*1: The values of sub-index 2 (Product Code) and sub-index 3 (Revision Number) for the Identity Object are below for each slave.

Slave	Product Code (hex)	Revision Number (hex)*1
FH-2050	0000 00FA	0001 0002
FH-2050-10	0000 00FB	0001 0002
FH-2050-20	0000 00FC	0001 0002
FH-5050	0000 00FD	0001 0002
FH-5050-10	0000 00FE	0001 0002
FH-5050-20	0000 00FF	0001 0002
FH-5550	0000 0103	0001 0002
FH-5550-10	0000 0104	0001 0002
FH-5550-20	0000 0105	0001 0002
FH-2052	0000 017D	0001 0004
FH-2052-10	0000 017E	0001 0004
FH-2052-20	0000 017F	0001 0004
FH-5052	0000 0183	0001 0004
FH-5052-10	0000 0184	0001 0004
FH-5052-20	0000 0185	0001 0004
FH-5552-20	0000 0186	0001 0004
FH-5552-20	0000 0187	0001 0004
FH-5552-20	0000 0188	0001 0004
FH-2051	0000 0145	0001 0003
FH-2051-10	0000 0146	0001 0003
FH-2051-20	0000 0147	0001 0003
FH-5051	0000 014B	0001 0003
FH-5051-10	0000 014C	0001 0003
FH-5051-20	0000 014D	0001 0003
FH-5551-20	0000 014E	0001 0003
FH-5551-20	0000 014F	0001 0003
FH-5551-20	0000 0150	0001 0003
FHV7H-M004+SDU30	0000 0109	0001 0000
FHV7H-C004+SDU30	0000 010A	0001 0000
FHV7H-M016+SDU30	0000 010B	0001 0000
FHV7H-C016+SDU30	0000 010C	0001 0000
FHV7H-M032+SDU30	0000 010D	0001 0000
FHV7H-C032+SDU30	0000 010E	0001 0000
FHV7H-M050+SDU30	0000 010F	0001 0000
FHV7H-C050+SDU30	0000 0110	0001 0000
FHV7H-M063R+SDU30	0000 0111	0001 0000
FHV7H-C063R+SDU30	0000 0112	0001 0000
FHV7H-M120R+SDU30	0000 0113	0001 0000
FHV7H-C120R+SDU30	0000 0114	0001 0000
FHV7X-M004+SDU30	0000 0170	0001 0001
FHV7X-C004+SDU30	0000 0171	0001 0001
FHV7X-M016+SDU30	0000 0172	0001 0001
FHV7X-C016+SDU30	0000 0173	0001 0001
FHV7X-M032+SDU30	0000 0174	0001 0001
FHV7X-C032+SDU30	0000 0175	0001 0001
FHV7X-M050+SDU30	0000 0176	0001 0001
FHV7X-C050+SDU30	0000 0177	0001 0001

Slave	Product Code (hex)	Revision Number (hex)*1
FHV7X-M063R+SDU30	0000 0178	0001 0001
FHV7X-C063R+SDU30	0000 0179	0001 0001
FHV7X-M120R+SDU30	0000 017A	0001 0001
FHV7X-C120R+SDU30	0000 017B	0001 0001

*1. The Revision Number changes according to the revision of the ESI file used.

10F3 hex	Diagnosis History		
Sub-index 0: Number of entries			
Range: -	Unit: -	Default: 0D hex	Attribute: -
Size: 1 byte (U8)	Access: RO		PDO map: Not possible
Sub-index 1: Maximum Messages			
Range: -	Unit: -	Default: 00 hex	Attribute: -
Size: 1 byte (U8)	Access: RO		PDO map: Not possible
Sub-index 2: Newest Message			
Range: -	Unit: -	Default: -	Attribute: -
Size: 1 byte (U8)	Access: RO		PDO map: Not possible
Sub-index 5: Flags			
Range: 0000 hex to 0001 hex	Unit: -	Default: 0000 hex to 0001 hex	Attribute: -
Size: 2 bytes (U16)	Access: RW		PDO map: Not possible
Sub-index 6 to 13: Diagnosis Message 1 to 8			
Range: -	Unit: -	Default: -	Attribute: -
Size: 23 bytes (VS)	Access: RO		PDO map: Not possible

- This objects indicates up to eight diagnosis histories. It also sets whether or not to notify emergency messages.
- Sub-index 1 (Maximum Messages) indicates the number of error messages.
- Sub-index 2 (Newest Message) indicates the sub-index number for the latest diagnosis history.
- Sub-index 5 (Flags) is the control flag for the diagnosis history. It sets whether or not to notify error messages via emergency messages. Setting 0001 hex means to notify. It is set to 0000 hex (no emergency notification) at startup.
- Eight errors are stored into the sub-index 6 to 13 sequentially. The 9th error and onward are stored into the sub-index 6 to 13 (Diagnosis message 1 to 8) again.
- The Sensor Controllers of the FH/FHV series support the flag only.

PDO Mapping Object

The indexes from 1600 hex to 17FF hex are used for RxPDO mapping, and from 1A00 hex to ABFF hex are for Tx PDO mapping. The sub-index 1 and onward indicate information for the application object to be mapped.

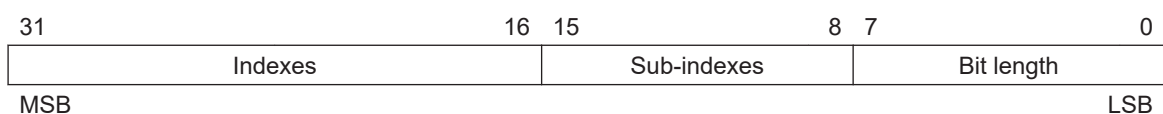

- Bit 0 to 7 : Bit length of the mapped object
(Ex.: for 32 bits, 20 hex is displays.)
- Bit 8 to 15 : Sub-index of the mapped object
- Bit 16 to 31 : Index of the mapped object

1600 hex	1st receive PDO Mapping		
Sub-index 0: Number of objects			
Range: -	Unit: -	Default: 32 hex	
Size: 1 byte (U8)	Access: RO		PDO map: Not possible
Sub-index1-32: 1st to 32nd Output Object to be mapped			
Range: -	Unit: -	Default: 70000101/70000201/70000901/70001001/700 01101 hex	
Size: 4 bytes (U32)	Access: RO		PDO map: Not possible

- The object gives the mapping for an application using Vision Sensor functions.
- The 7000 hex (control flag) is mapped in units of bit.

1601 hex	2nd receive PDO Mapping		
Sub-index 0: Number of objects			
Range: -	Unit: -	Default: 05 hex	
Size: 1 byte (U8)	Access: RO		PDO map: Not possible
Sub-index 1: 1st Output Object to be mapped			
Range: -	Unit: -	Default: 70010020 hex	
Size: 4 bytes (U32)	Access: RO		PDO map: Not possible
Sub-index 2: 2nd Output Object to be mapped			
Range: -	Unit: -	Default: 70020120 hex	
Size: 4 bytes (U32)	Access: RO		PDO map: Not possible
Sub-index 3: 3rd Output Object to be mapped			
Range: -	Unit: -	Default: 70020220 hex	
Size: 4 bytes (U32)	Access: RO		PDO map: Not possible
Sub-index 4: 4th Output Object to be mapped			
Range: -	Unit: -	Default: 70020320 hex	
Size: 4 bytes (U32)	Access: RO		PDO map: Not possible
Sub-index 5: 5th Output Object to be mapped			
Range: -	Unit: -	Default: 70020420 hex	
Size: 4 bytes (U32)	Access: RO		PDO map: Not possible

- The object gives the mapping for an application using Vision Sensor functions.
- 7001 hex (Vision Command Code)
- 7002 hex (Vision Command Parameter 1 to 3)

In multiple-line used, objects have been prepared for each line as shown below.

Line 1:1620 hex (1st receive PDO mapping) and 1621 hex (2nd receive PDO mapping)
 Line 2:1640 hex (1st receive PDO mapping) and 1641 hex (2nd receive PDO mapping)
 Line 3:1660 hex (1st receive PDO mapping) and 1661 hex (2nd receive PDO mapping)
 Line 4:1680 hex (1st receive PDO mapping) and 1681 hex (2nd receive PDO mapping)
 Line 5:16A0 hex (1st receive PDO mapping) and 16A1 hex (2nd receive PDO mapping)
 Line 6:16C0 hex (1st receive PDO mapping) and 16C1 hex (2nd receive PDO mapping)
 Line 7:16E0 hex (1st receive PDO mapping) and 16E1 hex (2nd receive PDO mapping)

1602 hex	3rd receive PDO Mapping		
Sub-index 0: Number of objects			
Range: -	Unit: -	Default: 06 hex	
Size: 1 byte (U8)	Access: RO		PDO map: Not possible

Sub-index 1: 1st Output Object to be mapped			
Range: -	Unit: -	Default: 70030120 hex	
Size: 4 bytes (U32)	Access: RO	PDO map: Not possible	
Sub-index 2: 2nd Output Object to be mapped			
Range: -	Unit: -	Default: 70030220 hex	
Size: 4 bytes (U32)	Access: RO	PDO map: Not possible	
Sub-index 3: 3rd Output Object to be mapped			
Range: -	Unit: -	Default: 70030320 hex	
Size: 4 bytes (U32)	Access: RO	PDO map: Not possible	
Sub-index 4: 4th Output Object to be mapped			
Range: -	Unit: -	Default: 70030420 hex	
Size: 4 bytes (U32)	Access: RO	PDO map: Not possible	
Sub-index 5: 5th Output Object to be mapped			
Range: -	Unit: -	Default: 70030540 hex	
Size: 4 bytes (U32)	Access: RO	PDO map: Not possible	
Sub-index 6: 6th Output Object to be mapped			
Range: -	Unit: -	Default: 70030640 hex	
Size: 4 bytes (U32)	Access: RO	PDO map: Not possible	

- The object gives the mapping for an application using Vision Sensor functions.
- 7001 hex (Vision Command Code)
- 7002 hex (Vision Command Parameter 1 to 3)
- 7003 hex (User Input Area)

In multiple-line used, objects have been prepared for each line as shown below.

Line 1: 1620 hex (1st receive PDO mapping), 1621 hex (2nd receive PDO mapping) and 1622 hex (3rd receive PDO mapping)

Line 2: 1640 hex (1st receive PDO mapping), 1641 hex (2nd receive PDO mapping) and 1642 hex (3rd receive PDO mapping)

Line 3: 1660 hex (1st receive PDO mapping), 1661 hex (2nd receive PDO mapping) and 1662 hex (3rd receive PDO mapping)

Line 4: 1680 hex (1st receive PDO mapping), 1681 hex (2nd receive PDO mapping) and 1682 hex (3rd receive PDO mapping)

Line 5: 16A0 hex (1st receive PDO mapping), 16A1 hex (2nd receive PDO mapping) and 16A2 hex (3rd receive PDO mapping)

Line 6: 16C0 hex (1st receive PDO mapping), 16C1 hex (2nd receive PDO mapping) and 16C2 hex (3rd receive PDO mapping)

Line 7: 16E0 hex (1st receive PDO mapping), 16E1 hex (2nd receive PDO mapping) and 16E2 hex (3rd receive PDO mapping)

1A00 hex	1st transmit PDO Mapping		
Sub-index 0: Number of objects			
Range: -	Unit: -	Default: 32 hex	
Size: 1 byte (U8)	Access: RO	PDO map: Not possible	
Sub-index 1: 1st to 32nd Input Object to be mapped			
Range: -	Unit: -	Default: 60000101/60000201/60000301/ 60000401/60000501/60000601/60000701/ 60000801/60000901/60000A01/60000B01/ 60001001/60001101 hex	

Size: 4 bytes (U32)	Access: RO	PDO map: Not possible
---------------------	------------	-----------------------

- The object gives the mapping for an application using Vision Sensor functions.
- The 6000 hex (control flag) is mapped in units of bit.

1A01 hex	2nd transmit PDO Mapping	
Sub-index 0: Number of objects		
Range: -	Unit: -	Default: 03 hex
Size: 1 byte (U8)	Access: RO	PDO map: Not possible
Sub-index 1: 1st Input Object to be mapped		
Range: -	Unit: -	Default: 60010020 hex
Size: 4 bytes (U32)	Access: RO	PDO map: Not possible
Sub-index 2: 2nd Input Object to be mapped		
Range: -	Unit: -	Default: 60020120 hex
Size: 4 bytes (U32)	Access: RO	PDO map: Not possible
Sub-index 3: 3rd Input Object to be mapped		
Range: -	Unit: -	Default: 60030120 hex
Size: 4 bytes (U32)	Access: RO	PDO map: Not possible

- The object gives the mapping for an application using Vision Sensor functions.
- 6001 hex (Echo Command)
- 6002 hex (Response Code)
- 6003 hex (Response Data)

1A02 hex	3rd transmit PDO Mapping	
Sub-index 0: Number of objects		
Range: -	Unit: -	Default: 03 hex
Size: 1 byte (U8)	Access: RO	PDO map: Not possible
Sub-index 1: 1st Input Object to be mapped		
Range: -	Unit: -	Default: 60040020 hex
Size: 4 bytes (U32)	Access: RO	PDO map: Not possible

- The object gives the mapping for an application using Vision Sensor functions.
- 6004 hex (Error Code)

1A04 hex	5th transmit PDO Mapping	
Sub-index 0: Number of objects		
Range: -	Unit: -	Default: 08 hex
Size: 1 byte (U8)	Access: RO	PDO map: Not possible
Sub-index 1: 1st Input Object to be mapped		
Range: -	Unit: -	Default: 60050120 hex
Size: 4 bytes (U32)	Access: RO	PDO map: Not possible
Sub-index 2: 2nd Input Object to be mapped		
Range: -	Unit: -	Default: 60050220 hex
Size: 4 bytes (U32)	Access: RO	PDO map: Not possible
Sub-index 3: 3rd Input Object to be mapped		
Range: -	Unit: -	Default: 60050320 hex
Size: 4 bytes (U32)	Access: RO	PDO map: Not possible
Sub-index 4: 4th Input Object to be mapped		
Range: -	Unit: -	Default: 60050420 hex

Size: 4 bytes (U32)	Access: RO	PDO map: Not possible
Sub-index 5: 5th Input Object to be mapped		
Range: -	Unit: -	Default: 60050520 hex
Size: 4 bytes (U32)	Access: RO	PDO map: Not possible
Sub-index 6: 6th Input Object to be mapped		
Range: -	Unit: -	Default: 60050620 hex
Size: 4 bytes (U32)	Access: RO	PDO map: Not possible
Sub-index 7: 7th Input Object to be mapped		
Range: -	Unit: -	Default: 60050720 hex
Size: 4 bytes (U32)	Access: RO	PDO map: Not possible
Sub-index 8: 8th Input Object to be mapped		
Range: -	Unit: -	Default: 60050820 hex
Size: 4 bytes (U32)	Access: RO	PDO map: Not possible

- The object gives the mapping for an application using Vision Sensor functions.
- 6005 hex (Image Processing Results Integer Data)

1A05 hex	6th transmit PDO Mapping	
Sub-index 0: Number of objects		
Range: -	Unit: -	Default: 16 hex
Size: 1 byte (U8)	Access: RO	PDO map: Not possible
Sub-index 1: 1st Input Object to be mapped		
Range: -	Unit: -	Default: 60050120 hex
Size: 4 bytes (U32)	Access: RO	PDO map: Not possible
Sub-index 2: 2nd Input Object to be mapped		
Range: -	Unit: -	Default: 60050220 hex
Size: 4 bytes (U32)	Access: RO	PDO map: Not possible
Sub-index 3: 3rd Input Object to be mapped		
Range: -	Unit: -	Default: 60050320 hex
Size: 4 bytes (U32)	Access: RO	PDO map: Not possible
Sub-index 4: 4th Input Object to be mapped		
Range: -	Unit: -	Default: 60050420 hex
Size: 4 bytes (U32)	Access: RO	PDO map: Not possible
Sub-index 5: 5th Input Object to be mapped		
Range: -	Unit: -	Default: 60050520 hex
Size: 4 bytes (U32)	Access: RO	PDO map: Not possible
Sub-index 6: 6th Input Object to be mapped		
Range: -	Unit: -	Default: 60050620 hex
Size: 4 bytes (U32)	Access: RO	PDO map: Not possible
Sub-index 7: 7th Input Object to be mapped		
Range: -	Unit: -	Default: 60050720 hex
Size: 4 bytes (U32)	Access: RO	PDO map: Not possible
Sub-index 8: 8th Input Object to be mapped		
Range: -	Unit: -	Default: 60050820 hex
Size: 4 bytes (U32)	Access: RO	PDO map: Not possible
Sub-index 9: 9th Input Object to be mapped		
Range: -	Unit: -	Default: 60050920 hex
Size: 4 bytes (U32)	Access: RO	PDO map: Not possible
Sub-index 10: 10th Input Object to be mapped		

Range: -	Unit: -	Default: 60050A20 hex
Size: 4 bytes (U32)	Access: RO	PDO map: Not possible
Sub-index 11: 11th Input Object to be mapped		
Range: -	Unit: -	Default: 60050B20 hex
Size: 4 bytes (U32)	Access: RO	PDO map: Not possible
Sub-index 12: 12th Input Object to be mapped		
Range: -	Unit: -	Default: 60050C20 hex
Size: 4 bytes (U32)	Access: RO	PDO map: Not possible
Sub-index 13: 13th Input Object to be mapped		
Range: -	Unit: -	Default: 60050D20 hex
Size: 4 bytes (U32)	Access: RO	PDO map: Not possible
Sub-index 14: 14th Input Object to be mapped		
Range: -	Unit: -	Default: 60050E20 hex
Size: 4 bytes (U32)	Access: RO	PDO map: Not possible
Sub-index 15: 15th Input Object to be mapped		
Range: -	Unit: -	Default: 60050F20 hex
Size: 4 bytes (U32)	Access: RO	PDO map: Not possible
Sub-index 16: 16th Input Object to be mapped		
Range: -	Unit: -	Default: 60051020 hex
Size: 4 bytes (U32)	Access: RO	PDO map: Not possible

- The object gives the mapping for an application using Vision Sensor functions.
- 6005 hex (Image Processing Results Integer Data)

1A06 hex	7th transmit PDO Mapping	
Sub-index 0: Number of objects		
Range: -	Unit: -	Default: 32 hex
Size: 1 byte (U8)	Access: RO	PDO map: Not possible
Sub-index 1: 1st Input Object to be mapped		
Range: -	Unit: -	Default: 60050120 hex
Size: 4 bytes (U32)	Access: RO	PDO map: Not possible
Sub-index 2: 2nd Input Object to be mapped		
Range: -	Unit: -	Default: 60050220 hex
Size: 4 bytes (U32)	Access: RO	PDO map: Not possible
Sub-index 3: 3rd Input Object to be mapped		
Range: -	Unit: -	Default: 60050320 hex
Size: 4 bytes (U32)	Access: RO	PDO map: Not possible
Sub-index 4: 4th Input Object to be mapped		
Range: -	Unit: -	Default: 60050420 hex
Size: 4 bytes (U32)	Access: RO	PDO map: Not possible
Sub-index 5: 5th Input Object to be mapped		
Range: -	Unit: -	Default: 60050520 hex
Size: 4 bytes (U32)	Access: RO	PDO map: Not possible
Sub-index 6: 6th Input Object to be mapped		
Range: -	Unit: -	Default: 60050620 hex
Size: 4 bytes (U32)	Access: RO	PDO map: Not possible
Sub-index 7: 7th Input Object to be mapped		
Range: -	Unit: -	Default: 60050720 hex
Size: 4 bytes (U32)	Access: RO	PDO map: Not possible

Sub-index 8: 8th Input Object to be mapped			
Range: -	Unit: -	Default: 60050820 hex	
Size: 4 bytes (U32)	Access: RO	PDO map: Not possible	
Sub-index 9: 9th Input Object to be mapped			
Range: -	Unit: -	Default: 60050920 hex	
Size: 4 bytes (U32)	Access: RO	PDO map: Not possible	
Sub-index 10: 10th Input Object to be mapped			
Range: -	Unit: -	Default: 60050A20 hex	
Size: 4 bytes (U32)	Access: RO	PDO map: Not possible	
Sub-index 11: 11th Input Object to be mapped			
Range: -	Unit: -	Default: 60050B20 hex	
Size: 4 bytes (U32)	Access: RO	PDO map: Not possible	
Sub-index 12: 12th Input Object to be mapped			
Range: -	Unit: -	Default: 60050C20 hex	
Size: 4 bytes (U32)	Access: RO	PDO map: Not possible	
Sub-index 13: 13th Input Object to be mapped			
Range: -	Unit: -	Default: 60050D20 hex	
Size: 4 bytes (U32)	Access: RO	PDO map: Not possible	
Sub-index 14: 14th Input Object to be mapped			
Range: -	Unit: -	Default: 60050E20 hex	
Size: 4 bytes (U32)	Access: RO	PDO map: Not possible	
Sub-index 15: 15th Input Object to be mapped			
Range: -	Unit: -	Default: 60050F20 hex	
Size: 4 bytes (U32)	Access: RO	PDO map: Not possible	
Sub-index 16: 16th Input Object to be mapped			
Range: -	Unit: -	Default: 60051020 hex	
Size: 4 bytes (U32)	Access: RO	PDO map: Not possible	
Sub-index 17: 17th Input Object to be mapped			
Range: -	Unit: -	Default: 60051120 hex	
Size: 4 bytes (U32)	Access: RO	PDO map: Not possible	
Sub-index 18: 18th Input Object to be mapped			
Range: -	Unit: -	Default: 60051220 hex	
Size: 4 bytes (U32)	Access: RO	PDO map: Not possible	
Sub-index 19: 19th Input Object to be mapped			
Range: -	Unit: -	Default: 60051320 hex	
Size: 4 bytes (U32)	Access: RO	PDO map: Not possible	
Sub-index 20: 20th Input Object to be mapped			
Range: -	Unit: -	Default: 60051420 hex	
Size: 4 bytes (U32)	Access: RO	PDO map: Not possible	
Sub-index 21: 21st Input Object to be mapped			
Range: -	Unit: -	Default: 60051520 hex	
Size: 4 bytes (U32)	Access: RO	PDO map: Not possible	
Sub-index 22: 22nd Input Object to be mapped			
Range: -	Unit: -	Default: 60051620 hex	
Size: 4 bytes (U32)	Access: RO	PDO map: Not possible	
Sub-index 23: 23rd Input Object to be mapped			
Range: -	Unit: -	Default: 60051720 hex	
Size: 4 bytes (U32)	Access: RO	PDO map: Not possible	

Sub-index 24: 24th Input Object to be mapped			
Range: -	Unit: -	Default: 60051820 hex	
Size: 4 bytes (U32)	Access: RO	PDO map: Not possible	
Sub-index 25: 25th Input Object to be mapped			
Range: -	Unit: -	Default: 60051920 hex	
Size: 4 bytes (U32)	Access: RO	PDO map: Not possible	
Sub-index 26: 26th Input Object to be mapped			
Range: -	Unit: -	Default: 60051A20 hex	
Size: 4 bytes (U32)	Access: RO	PDO map: Not possible	
Sub-index 27: 27th Input Object to be mapped			
Range: -	Unit: -	Default: 60051B20 hex	
Size: 4 bytes (U32)	Access: RO	PDO map: Not possible	
Sub-index 28: 28th Input Object to be mapped			
Range: -	Unit: -	Default: 60051C20 hex	
Size: 4 bytes (U32)	Access: RO	PDO map: Not possible	
Sub-index 29: 29th Input Object to be mapped			
Range: -	Unit: -	Default: 60051D20 hex	
Size: 4 bytes (U32)	Access: RO	PDO map: Not possible	
Sub-index 30: 30th Input Object to be mapped			
Range: -	Unit: -	Default: 60051E20 hex	
Size: 4 bytes (U32)	Access: RO	PDO map: Not possible	
Sub-index 31: 31st Input Object to be mapped			
Range: -	Unit: -	Default: 60051F20 hex	
Size: 4 bytes (U32)	Access: RO	PDO map: Not possible	
Sub-index 32: 32nd Input Object to be mapped			
Range: -	Unit: -	Default: 60052020 hex	
Size: 4 bytes (U32)	Access: RO	PDO map: Not possible	

- The object gives the mapping for an application using Vision Sensor functions.
- 6005 hex (Image Processing Results Integer Data)

1A07 hex	8th transmit PDO Mapping		
Sub-index 0: Number of objects			
Range: -	Unit: -	Default: 64 hex	
Size: 1 byte (U8)	Access: RO	PDO map: Not possible	
Sub-index 1: 1st Input Object to be mapped			
Range: -	Unit: -	Default: 60050120 hex	
Size: 4 bytes (U32)	Access: RO	PDO map: Not possible	
Sub-index 2: 2nd Input Object to be mapped			
Range: -	Unit: -	Default: 60050220 hex	
Size: 4 bytes (U32)	Access: RO	PDO map: Not possible	
Sub-index 3: 3rd Input Object to be mapped			
Range: -	Unit: -	Default: 60050320 hex	
Size: 4 bytes (U32)	Access: RO	PDO map: Not possible	
Sub-index 4: 4th Input Object to be mapped			
Range: -	Unit: -	Default: 60050420 hex	
Size: 4 bytes (U32)	Access: RO	PDO map: Not possible	
Sub-index 5: 5th Input Object to be mapped			
Range: -	Unit: -	Default: 60050520 hex	

Size: 4 bytes (U32)	Access: RO	PDO map: Not possible
Sub-index 6: 6th Input Object to be mapped		
Range: -	Unit: -	Default: 60050620 hex
Size: 4 bytes (U32)	Access: RO	PDO map: Not possible
Sub-index 7: 7th Input Object to be mapped		
Range: -	Unit: -	Default: 60050720 hex
Size: 4 bytes (U32)	Access: RO	PDO map: Not possible
Sub-index 8: 8th Input Object to be mapped		
Range: -	Unit: -	Default: 60050820 hex
Size: 4 bytes (U32)	Access: RO	PDO map: Not possible
Sub-index 9: 9th Input Object to be mapped		
Range: -	Unit: -	Default: 60050920 hex
Size: 4 bytes (U32)	Access: RO	PDO map: Not possible
Sub-index 10: 10th Input Object to be mapped		
Range: -	Unit: -	Default: 60050A20 hex
Size: 4 bytes (U32)	Access: RO	PDO map: Not possible
Sub-index 11: 11th Input Object to be mapped		
Range: -	Unit: -	Default: 60050B20 hex
Size: 4 bytes (U32)	Access: RO	PDO map: Not possible
Sub-index 12: 12th Input Object to be mapped		
Range: -	Unit: -	Default: 60050C20 hex
Size: 4 bytes (U32)	Access: RO	PDO map: Not possible
Sub-index 13: 13th Input Object to be mapped		
Range: -	Unit: -	Default: 60050D20 hex
Size: 4 bytes (U32)	Access: RO	PDO map: Not possible
Sub-index 14: 14th Input Object to be mapped		
Range: -	Unit: -	Default: 60050E20 hex
Size: 4 bytes (U32)	Access: RO	PDO map: Not possible
Sub-index 15: 15th Input Object to be mapped		
Range: -	Unit: -	Default: 60050F20 hex
Size: 4 bytes (U32)	Access: RO	PDO map: Not possible
Sub-index 16: 16th Input Object to be mapped		
Range: -	Unit: -	Default: 60051020 hex
Size: 4 bytes (U32)	Access: RO	PDO map: Not possible
Sub-index 17: 17th Input Object to be mapped		
Range: -	Unit: -	Default: 60051120 hex
Size: 4 bytes (U32)	Access: RO	PDO map: Not possible
Sub-index 18: 18th Input Object to be mapped		
Range: -	Unit: -	Default: 60051220 hex
Size: 4 bytes (U32)	Access: RO	PDO map: Not possible
Sub-index 19: 19th Input Object to be mapped		
Range: -	Unit: -	Default: 60051320 hex
Size: 4 bytes (U32)	Access: RO	PDO map: Not possible
Sub-index 20: 20th Input Object to be mapped		
Range: -	Unit: -	Default: 60051420 hex
Size: 4 bytes (U32)	Access: RO	PDO map: Not possible
Sub-index 21: 21st Input Object to be mapped		
Range: -	Unit: -	Default: 60051520 hex

Size: 4 bytes (U32)	Access: RO	PDO map: Not possible
Sub-index 22: 22nd Input Object to be mapped		
Range: -	Unit: -	Default: 60051620 hex
Size: 4 bytes (U32)	Access: RO	PDO map: Not possible
Sub-index 23: 23rd Input Object to be mapped		
Range: -	Unit: -	Default: 60051720 hex
Size: 4 bytes (U32)	Access: RO	PDO map: Not possible
Sub-index 24: 24th Input Object to be mapped		
Range: -	Unit: -	Default: 60051820 hex
Size: 4 bytes (U32)	Access: RO	PDO map: Not possible
Sub-index 25: 25th Input Object to be mapped		
Range: -	Unit: -	Default: 60051920 hex
Size: 4 bytes (U32)	Access: RO	PDO map: Not possible
Sub-index 26: 26th Input Object to be mapped		
Range: -	Unit: -	Default: 60051A20 hex
Size: 4 bytes (U32)	Access: RO	PDO map: Not possible
Sub-index 27: 27th Input Object to be mapped		
Range: -	Unit: -	Default: 60051B20 hex
Size: 4 bytes (U32)	Access: RO	PDO map: Not possible
Sub-index 28: 28th Input Object to be mapped		
Range: -	Unit: -	Default: 60051C20 hex
Size: 4 bytes (U32)	Access: RO	PDO map: Not possible
Sub-index 29: 29th Input Object to be mapped		
Range: -	Unit: -	Default: 60051D20 hex
Size: 4 bytes (U32)	Access: RO	PDO map: Not possible
Sub-index 30: 30th Input Object to be mapped		
Range: -	Unit: -	Default: 60051E20 hex
Size: 4 bytes (U32)	Access: RO	PDO map: Not possible
Sub-index 31: 31st Input Object to be mapped		
Range: -	Unit: -	Default: 60051F20 hex
Size: 4 bytes (U32)	Access: RO	PDO map: Not possible
Sub-index 32: 32nd Input Object to be mapped		
Range: -	Unit: -	Default: 60052020 hex
Size: 4 bytes (U32)	Access: RO	PDO map: Not possible
Sub-index 33: 33rd Input Object to be mapped		
Range: -	Unit: -	Default: 60052120 hex
Size: 4 bytes (U32)	Access: RO	PDO map: Not possible
Sub-index 34: 34th Input Object to be mapped		
Range: -	Unit: -	Default: 60052220 hex
Size: 4 bytes (U32)	Access: RO	PDO map: Not possible
Sub-index 35: 35th Input Object to be mapped		
Range: -	Unit: -	Default: 60052320 hex
Size: 4 bytes (U32)	Access: RO	PDO map: Not possible
Sub-index 36: 36th Input Object to be mapped		
Range: -	Unit: -	Default: 60052420 hex
Size: 4 bytes (U32)	Access: RO	PDO map: Not possible
Sub-index 37: 37th Input Object to be mapped		
Range: -	Unit: -	Default: 60052520 hex

Size: 4 bytes (U32)	Access: RO	PDO map: Not possible
Sub-index 38: 38th Input Object to be mapped		
Range: -	Unit: -	Default: 60052620 hex
Size: 4 bytes (U32)	Access: RO	PDO map: Not possible
Sub-index 39: 39th Input Object to be mapped		
Range: -	Unit: -	Default: 60052720 hex
Size: 4 bytes (U32)	Access: RO	PDO map: Not possible
Sub-index 40: 40th Input Object to be mapped		
Range: -	Unit: -	Default: 60052820 hex
Size: 4 bytes (U32)	Access: RO	PDO map: Not possible
Sub-index 41: 41st Input Object to be mapped		
Range: -	Unit: -	Default: 60052920 hex
Size: 4 bytes (U32)	Access: RO	PDO map: Not possible
Sub-index 42: 42nd Input Object to be mapped		
Range: -	Unit: -	Default: 60052A20 hex
Size: 4 bytes (U32)	Access: RO	PDO map: Not possible
Sub-index 43: 43rd Input Object to be mapped		
Range: -	Unit: -	Default: 60052B20 hex
Size: 4 bytes (U32)	Access: RO	PDO map: Not possible
Sub-index 44: 44th Input Object to be mapped		
Range: -	Unit: -	Default: 60052C20 hex
Size: 4 bytes (U32)	Access: RO	PDO map: Not possible
Sub-index 45: 45th Input Object to be mapped		
Range: -	Unit: -	Default: 60052D20 hex
Size: 4 bytes (U32)	Access: RO	PDO map: Not possible
Sub-index 46: 46th Input Object to be mapped		
Range: -	Unit: -	Default: 60052E20 hex
Size: 4 bytes (U32)	Access: RO	PDO map: Not possible
Sub-index 47: 47th Input Object to be mapped		
Range: -	Unit: -	Default: 60052F20 hex
Size: 4 bytes (U32)	Access: RO	PDO map: Not possible
Sub-index 48: 48th Input Object to be mapped		
Range: -	Unit: -	Default: 60053020 hex
Size: 4 bytes (U32)	Access: RO	PDO map: Not possible
Sub-index 49: 49th Input Object to be mapped		
Range: -	Unit: -	Default: 60053120 hex
Size: 4 bytes (U32)	Access: RO	PDO map: Not possible
Sub-index 50: 50th Input Object to be mapped		
Range: -	Unit: -	Default: 60053220 hex
Size: 4 bytes (U32)	Access: RO	PDO map: Not possible
Sub-index 51: 51st Input Object to be mapped		
Range: -	Unit: -	Default: 60053320 hex
Size: 4 bytes (U32)	Access: RO	PDO map: Not possible
Sub-index 52: 52nd Input Object to be mapped		
Range: -	Unit: -	Default: 60053420 hex
Size: 4 bytes (U32)	Access: RO	PDO map: Not possible
Sub-index 53: 53rd Input Object to be mapped		
Range: -	Unit: -	Default: 60053520 hex

Size: 4 bytes (U32)	Access: RO	PDO map: Not possible
Sub-index 54: 54th Input Object to be mapped		
Range: -	Unit: -	Default: 60053620 hex
Size: 4 bytes (U32)	Access: RO	PDO map: Not possible
Sub-index 55: 55th Input Object to be mapped		
Range: -	Unit: -	Default: 60053720 hex
Size: 4 bytes (U32)	Access: RO	PDO map: Not possible
Sub-index 56: 56th Input Object to be mapped		
Range: -	Unit: -	Default: 60053820 hex
Size: 4 bytes (U32)	Access: RO	PDO map: Not possible
Sub-index 57: 57th Input Object to be mapped		
Range: -	Unit: -	Default: 60053920 hex
Size: 4 bytes (U32)	Access: RO	PDO map: Not possible
Sub-index 58: 58th Input Object to be mapped		
Range: -	Unit: -	Default: 60053A20 hex
Size: 4 bytes (U32)	Access: RO	PDO map: Not possible
Sub-index 59: 59th Input Object to be mapped		
Range: -	Unit: -	Default: 60053B20 hex
Size: 4 bytes (U32)	Access: RO	PDO map: Not possible
Sub-index 60: 60th Input Object to be mapped		
Range: -	Unit: -	Default: 60053C20 hex
Size: 4 bytes (U32)	Access: RO	PDO map: Not possible
Sub-index 61: 61st Input Object to be mapped		
Range: -	Unit: -	Default: 60053D20 hex
Size: 4 bytes (U32)	Access: RO	PDO map: Not possible
Sub-index 62: 62nd Input Object to be mapped		
Range: -	Unit: -	Default: 60053E20 hex
Size: 4 bytes (U32)	Access: RO	PDO map: Not possible
Sub-index 63: 63rd Input Object to be mapped		
Range: -	Unit: -	Default: 60053F20 hex
Size: 4 bytes (U32)	Access: RO	PDO map: Not possible
Sub-index 64: 64th Input Object to be mapped		
Range: -	Unit: -	Default: 60054020 hex
Size: 4 bytes (U32)	Access: RO	PDO map: Not possible

- The object gives the mapping for an application using Vision Sensor functions.
- 6005 hex (Image Processing Results Integer Data)

1A08 hex	9th transmit PDO Mapping	
Sub-index 0: Number of objects		
Range: -	Unit: -	Default: 4 hex
Size: 1 byte (U8)	Access: RO	PDO map: Not possible
Sub-index 1: 1st Input Object to be mapped		
Range: -	Unit: -	Default: 60060140 hex
Size: 4 bytes (U32)	Access: RO	PDO map: Not possible
Sub-index 2: 2nd Input Object to be mapped		
Range: -	Unit: -	Default: 60060240 hex
Size: 4 bytes (U32)	Access: RO	PDO map: Not possible
Sub-index 3: 3rd Input Object to be mapped		

Range: -	Unit: -	Default: 60060340 hex
Size: 4 bytes (U32)	Access: RO	PDO map: Not possible
Sub-index 4: 4th Input Object to be mapped		
Range: -	Unit: -	Default: 60060440 hex
Size: 4 bytes (U32)	Access: RO	PDO map: Not possible

- The object gives the mapping for an application using Vision Sensor functions.
- 6006 hex (Image Processing Results Real Data)

1A09 hex	10th transmit PDO Mapping	
Sub-index 0: Number of objects		
Range: -	Unit: -	Default: 16 hex
Size: 1 byte (U8)	Access: RO	PDO map: Not possible
Sub-index 1: 1st Input Object to be mapped		
Range: -	Unit: -	Default: 60060140 hex
Size: 4 bytes (U32)	Access: RO	PDO map: Not possible
Sub-index 2: 2nd Input Object to be mapped		
Range: -	Unit: -	Default: 60060240 hex
Size: 4 bytes (U32)	Access: RO	PDO map: Not possible
Sub-index 3: 3rd Input Object to be mapped		
Range: -	Unit: -	Default: 60060340 hex
Size: 4 bytes (U32)	Access: RO	PDO map: Not possible
Sub-index 4: 4th Input Object to be mapped		
Range: -	Unit: -	Default: 60060440 hex
Size: 4 bytes (U32)	Access: RO	PDO map: Not possible
Sub-index 5: 5th Input Object to be mapped		
Range: -	Unit: -	Default: 60060540 hex
Size: 4 bytes (U32)	Access: RO	PDO map: Not possible
Sub-index 6: 6th Input Object to be mapped		
Range: -	Unit: -	Default: 60060640 hex
Size: 4 bytes (U32)	Access: RO	PDO map: Not possible
Sub-index 7: 7th Input Object to be mapped		
Range: -	Unit: -	Default: 60060740 hex
Size: 4 bytes (U32)	Access: RO	PDO map: Not possible
Sub-index 8: 8th Input Object to be mapped		
Range: -	Unit: -	Default: 60060840 hex
Size: 4 bytes (U32)	Access: RO	PDO map: Not possible

- The object gives the mapping for an application using Vision Sensor functions.
- 6006 hex (Image Processing Results Real Data)

1A0A hex	11th transmit PDO Mapping	
Sub-index 0: Number of objects		
Range: -	Unit: -	Default: 16 hex
Size: 1 byte (U8)	Access: RO	PDO map: Not possible
Sub-index 1: 1st Input Object to be mapped		
Range: -	Unit: -	Default: 60060140 hex
Size: 4 bytes (U32)	Access: RO	PDO map: Not possible
Sub-index 2: 2nd Input Object to be mapped		

Range: -	Unit: -	Default: 60060240 hex
Size: 4 bytes (U32)	Access: RO	PDO map: Not possible
Sub-index 3: 3rd Input Object to be mapped		
Range: -	Unit: -	Default: 60060340 hex
Size: 4 bytes (U32)	Access: RO	PDO map: Not possible
Sub-index 4: 4th Input Object to be mapped		
Range: -	Unit: -	Default: 60060440 hex
Size: 4 bytes (U32)	Access: RO	PDO map: Not possible
Sub-index 5: 5th Input Object to be mapped		
Range: -	Unit: -	Default: 60060540 hex
Size: 4 bytes (U32)	Access: RO	PDO map: Not possible
Sub-index 6: 6th Input Object to be mapped		
Range: -	Unit: -	Default: 60060640 hex
Size: 4 bytes (U32)	Access: RO	PDO map: Not possible
Sub-index 7: 7th Input Object to be mapped		
Range: -	Unit: -	Default: 60060740 hex
Size: 4 bytes (U32)	Access: RO	PDO map: Not possible
Sub-index 8: 8th Input Object to be mapped		
Range: -	Unit: -	Default: 60060840 hex
Size: 4 bytes (U32)	Access: RO	PDO map: Not possible
Sub-index 9: 9th Input Object to be mapped		
Range: -	Unit: -	Default: 60060940 hex
Size: 4 bytes (U32)	Access: RO	PDO map: Not possible
Sub-index 10: 10th Input Object to be mapped		
Range: -	Unit: -	Default: 60060A40 hex
Size: 4 bytes (U32)	Access: RO	PDO map: Not possible
Sub-index 11: 11th Input Object to be mapped		
Range: -	Unit: -	Default: 60060B40 hex
Size: 4 bytes (U32)	Access: RO	PDO map: Not possible
Sub-index 12: 12th Input Object to be mapped		
Range: -	Unit: -	Default: 60060C40 hex
Size: 4 bytes (U32)	Access: RO	PDO map: Not possible
Sub-index 13: 13th Input Object to be mapped		
Range: -	Unit: -	Default: 60060D40 hex
Size: 4 bytes (U32)	Access: RO	PDO map: Not possible
Sub-index 14: 14th Input Object to be mapped		
Range: -	Unit: -	Default: 60060E40 hex
Size: 4 bytes (U32)	Access: RO	PDO map: Not possible
Sub-index 15: 15th Input Object to be mapped		
Range: -	Unit: -	Default: 60060F40 hex
Size: 4 bytes (U32)	Access: RO	PDO map: Not possible
Sub-index 16: 16th Input Object to be mapped		
Range: -	Unit: -	Default: 60061040 hex
Size: 4 bytes (U32)	Access: RO	PDO map: Not possible

- The object gives the mapping for an application using Vision Sensor functions.
- 6006 hex (Image Processing Results Real Data)

1A0B hex	12th transmit PDO Mapping
----------	---------------------------

Sub-index 0: Number of objects			
Range: -	Unit: -	Default: 64 hex	
Size: 1 byte (U8)	Access: RO	PDO map: Not possible	
Sub-index 1: 1st Input Object to be mapped			
Range: -	Unit: -	Default: 60060140 hex	
Size: 4 bytes (U32)	Access: RO	PDO map: Not possible	
Sub-index 2: 2nd Input Object to be mapped			
Range: -	Unit: -	Default: 60060240 hex	
Size: 4 bytes (U32)	Access: RO	PDO map: Not possible	
Sub-index 3: 3rd Input Object to be mapped			
Range: -	Unit: -	Default: 60060340 hex	
Size: 4 bytes (U32)	Access: RO	PDO map: Not possible	
Sub-index 4: 4th Input Object to be mapped			
Range: -	Unit: -	Default: 60060440 hex	
Size: 4 bytes (U32)	Access: RO	PDO map: Not possible	
Sub-index 5: 5th Input Object to be mapped			
Range: -	Unit: -	Default: 60060540 hex	
Size: 4 bytes (U32)	Access: RO	PDO map: Not possible	
Sub-index 6: 6th Input Object to be mapped			
Range: -	Unit: -	Default: 60060640 hex	
Size: 4 bytes (U32)	Access: RO	PDO map: Not possible	
Sub-index 7: 7th Input Object to be mapped			
Range: -	Unit: -	Default: 60060740 hex	
Size: 4 bytes (U32)	Access: RO	PDO map: Not possible	
Sub-index 8: 8th Input Object to be mapped			
Range: -	Unit: -	Default: 60060840 hex	
Size: 4 bytes (U32)	Access: RO	PDO map: Not possible	
Sub-index 9: 9th Input Object to be mapped			
Range: -	Unit: -	Default: 60060940 hex	
Size: 4 bytes (U32)	Access: RO	PDO map: Not possible	
Sub-index 10: 10th Input Object to be mapped			
Range: -	Unit: -	Default: 60060A40 hex	
Size: 4 bytes (U32)	Access: RO	PDO map: Not possible	
Sub-index 11: 11th Input Object to be mapped			
Range: -	Unit: -	Default: 60060B40 hex	
Size: 4 bytes (U32)	Access: RO	PDO map: Not possible	
Sub-index 12: 12th Input Object to be mapped			
Range: -	Unit: -	Default: 60060C40 hex	
Size: 4 bytes (U32)	Access: RO	PDO map: Not possible	
Sub-index 13: 13th Input Object to be mapped			
Range: -	Unit: -	Default: 60060D40 hex	
Size: 4 bytes (U32)	Access: RO	PDO map: Not possible	
Sub-index 14: 14th Input Object to be mapped			
Range: -	Unit: -	Default: 60060E40 hex	
Size: 4 bytes (U32)	Access: RO	PDO map: Not possible	
Sub-index 15: 15th Input Object to be mapped			
Range: -	Unit: -	Default: 60060F40 hex	
Size: 4 bytes (U32)	Access: RO	PDO map: Not possible	

Sub-index 16: 16th Input Object to be mapped			
Range: -	Unit: -	Default: 60061040 hex	
Size: 4 bytes (U32)	Access: RO	PDO map: Not possible	
Sub-index 17: 17th Input Object to be mapped			
Range: -	Unit: -	Default: 60061140 hex	
Size: 4 bytes (U32)	Access: RO	PDO map: Not possible	
Sub-index 18: 18th Input Object to be mapped			
Range: -	Unit: -	Default: 60061240 hex	
Size: 4 bytes (U32)	Access: RO	PDO map: Not possible	
Sub-index 19: 19th Input Object to be mapped			
Range: -	Unit: -	Default: 60061340 hex	
Size: 4 bytes (U32)	Access: RO	PDO map: Not possible	
Sub-index 20: 20th Input Object to be mapped			
Range: -	Unit: -	Default: 60061440 Hex	
Size: 4 bytes (U32)	Access: RO	PDO map: Not possible	
Sub-index 21: 21st Input Object to be mapped			
Range: -	Unit: -	Default: 60061540 hex	
Size: 4 bytes (U32)	Access: RO	PDO map: Not possible	
Sub-index 22: 22nd Input Object to be mapped			
Range: -	Unit: -	Default: 60061640 hex	
Size: 4 bytes (U32)	Access: RO	PDO map: Not possible	
Sub-index 23: 23rd Input Object to be mapped			
Range: -	Unit: -	Default: 60061740 hex	
Size: 4 bytes (U32)	Access: RO	PDO map: Not possible	
Sub-index 24: 24th Input Object to be mapped			
Range: -	Unit: -	Default: 60061840 hex	
Size: 4 bytes (U32)	Access: RO	PDO map: Not possible	
Sub-index 25: 25th Input Object to be mapped			
Range: -	Unit: -	Default: 60061940 hex	
Size: 4 bytes (U32)	Access: RO	PDO map: Not possible	
Sub-index 26: 26th Input Object to be mapped			
Range: -	Unit: -	Default: 60061A40 hex	
Size: 4 bytes (U32)	Access: RO	PDO map: Not possible	
Sub-index 27: 27th Input Object to be mapped			
Range: -	Unit: -	Default: 60061B40 hex	
Size: 4 bytes (U32)	Access: RO	PDO map: Not possible	
Sub-index 28: 28th Input Object to be mapped			
Range: -	Unit: -	Default: 60061C40 hex	
Size: 4 bytes (U32)	Access: RO	PDO map: Not possible	
Sub-index 29: 29th Input Object to be mapped			
Range: -	Unit: -	Default: 60061D40 hex	
Size: 4 bytes (U32)	Access: RO	PDO map: Not possible	
Sub-index 30: 30th Input Object to be mapped			
Range: -	Unit: -	Default: 60061E40 hex	
Size: 4 bytes (U32)	Access: RO	PDO map: Not possible	
Sub-index 31: 31st Input Object to be mapped			
Range: -	Unit: -	Default: 60061F40 hex	
Size: 4 bytes (U32)	Access: RO	PDO map: Not possible	

Sub-index 32: 32nd Input Object to be mapped			
Range: -	Unit: -	Default: 60062040 hex	
Size: 4 bytes (U32)	Access: RO	PDO map: Not possible	

- The object gives the mapping for an application using Vision Sensor functions.
- 6006 hex (Image Processing Results Real Data)

1A0C hex	13th transmit PDO Mapping		
Sub-index 0: Number of objects			
Range: -	Unit: -	Default: 5 hex	
Size: 1 byte (U8)	Access: RO	PDO map: Not possible	
Sub-index 1: 1st Input Object to be mapped			
Range: -	Unit: -	Default: 60050120 hex	
Size: 4 bytes (U32)	Access: RO	PDO map: Not possible	
Sub-index 2: 2nd Input Object to be mapped			
Range: -	Unit: -	Default: 60050220 hex	
Size: 4 bytes (U32)	Access: RO	PDO map: Not possible	
Sub-index 3: 3rd Input Object to be mapped			
Range: -	Unit: -	Default: 60060140 hex	
Size: 4 bytes (U32)	Access: RO	PDO map: Not possible	
Sub-index 4: 4th Input Object to be mapped			
Range: -	Unit: -	Default: 60060240 hex	
Size: 4 bytes (U32)	Access: RO	PDO map: Not possible	
Sub-index 5: 5th Input Object to be mapped			
Range: -	Unit: -	Default: 60060340 hex	
Size: 4 bytes (U32)	Access: RO	PDO map: Not possible	

- The object gives the mapping for an application using Vision Sensor functions.
- 6005 hex (Image Processing Results Integer Data)
- 6006 hex (Image Processing Results Real Data)

1A0D hex	14th transmit PDO Mapping		
Sub-index 0: Number of objects			
Range: -	Unit: -	Default: 10 hex	
Size: 1 byte (U8)	Access: RO	PDO map: Not possible	
Sub-index 1: 1st Input Object to be mapped			
Range: -	Unit: -	Default: 60050120 hex	
Size: 4 bytes (U32)	Access: RO	PDO map: Not possible	
Sub-index 2: 2nd Input Object to be mapped			
Range: -	Unit: -	Default: 60050220 hex	
Size: 4 bytes (U32)	Access: RO	PDO map: Not possible	
Sub-index 3: 3rd Input Object to be mapped			
Range: -	Unit: -	Default: 60050320 hex	
Size: 4 bytes (U32)	Access: RO	PDO map: Not possible	
Sub-index 4: 4th Input Object to be mapped			
Range: -	Unit: -	Default: 60050420 hex	
Size: 4 bytes (U32)	Access: RO	PDO map: Not possible	
Sub-index 5: 5th Input Object to be mapped			
Range: -	Unit: -	Default: 60060140 hex	
Size: 4 bytes (U32)	Access: RO	PDO map: Not possible	

Sub-index 6: 6th Input Object to be mapped			
Range: -	Unit: -	Default: 60060240 hex	
Size: 4 bytes (U32)	Access: RO	PDO map: Not possible	
Sub-index 7: 7th Input Object to be mapped			
Range: -	Unit: -	Default: 60060340 hex	
Size: 4 bytes (U32)	Access: RO	PDO map: Not possible	
Sub-index 8: 8th Input Object to be mapped			
Range: -	Unit: -	Default: 60060440 hex	
Size: 4 bytes (U32)	Access: RO	PDO map: Not possible	
Sub-index 9: 9th Input Object to be mapped			
Range: -	Unit: -	Default: 60060540 hex	
Size: 4 bytes (U32)	Access: RO	PDO map: Not possible	
Sub-index 10: 10th Input Object to be mapped			
Range: -	Unit: -	Default: 60060640 hex	
Size: 4 bytes (U32)	Access: RO	PDO map: Not possible	

- The object gives the mapping for an application using Vision Sensor functions.
- 6005 hex (Image Processing Results Integer Data)
- 6006 hex (Image Processing Results Real Data)

1A0E hex	15th transmit PDO Mapping		
Sub-index 0: Number of objects			
Range: -	Unit: -	Default: 20 hex	
Size: 1 byte (U8)	Access: RO	PDO map: Not possible	
Sub-index 1: 1st Input Object to be mapped			
Range: -	Unit: -	Default: 60050120 hex	
Size: 4 bytes (U32)	Access: RO	PDO map: Not possible	
Sub-index 2: 2nd Input Object to be mapped			
Range: -	Unit: -	Default: 60050220 hex	
Size: 4 bytes (U32)	Access: RO	PDO map: Not possible	
Sub-index 3: 3rd Input Object to be mapped			
Range: -	Unit: -	Default: 60050320 hex	
Size: 4 bytes (U32)	Access: RO	PDO map: Not possible	
Sub-index 4: 4th Input Object to be mapped			
Range: -	Unit: -	Default: 60050420 hex	
Size: 4 bytes (U32)	Access: RO	PDO map: Not possible	
Sub-index 5: 5th Input Object to be mapped			
Range: -	Unit: -	Default: 60060520 hex	
Size: 4 bytes (U32)	Access: RO	PDO map: Not possible	
Sub-index 6: 6th Input Object to be mapped			
Range: -	Unit: -	Default: 60060620 hex	
Size: 4 bytes (U32)	Access: RO	PDO map: Not possible	
Sub-index 7: 7th Input Object to be mapped			
Range: -	Unit: -	Default: 60060720 hex	
Size: 4 bytes (U32)	Access: RO	PDO map: Not possible	
Sub-index 8: 8th Input Object to be mapped			
Range: -	Unit: -	Default: 60060820 hex	
Size: 4 bytes (U32)	Access: RO	PDO map: Not possible	
Sub-index 9: 9th Input Object to be mapped			

Range: -	Unit: -	Default: 60060410 hex	
Size: 4 bytes (U32)		Access: RO	PDO map: Not possible
Sub-index 10: 10th Input Object to be mapped			
Range: -	Unit: -	Default: 60060420 hex	
Size: 4 bytes (U32)		Access: RO	PDO map: Not possible
Sub-index 11: 11th Input Object to be mapped			
Range: -	Unit: -	Default: 60060430 hex	
Size: 4 bytes (U32)		Access: RO	PDO map: Not possible
Sub-index 12: 12th Input Object to be mapped			
Range: -	Unit: -	Default: 60060440 hex	
Size: 4 bytes (U32)		Access: RO	PDO map: Not possible
Sub-index 13: 13th Input Object to be mapped			
Range: -	Unit: -	Default: 60060450 hex	
Size: 4 bytes (U32)		Access: RO	PDO map: Not possible
Sub-index 14: 14th Input Object to be mapped			
Range: -	Unit: -	Default: 60060460 hex	
Size: 4 bytes (U32)		Access: RO	PDO map: Not possible
Sub-index 15: 15th Input Object to be mapped			
Range: -	Unit: -	Default: 60060470 hex	
Size: 4 bytes (U32)		Access: RO	PDO map: Not possible
Sub-index 16: 16th Input Object to be mapped			
Range: -	Unit: -	Default: 60060480 hex	
Size: 4 bytes (U32)		Access: RO	PDO map: Not possible
Sub-index 17: 17th Input Object to be mapped			
Range: -	Unit: -	Default: 60060490 hex	
Size: 4 bytes (U32)		Access: RO	PDO map: Not possible
Sub-index 18: 18th Input Object to be mapped			
Range: -	Unit: -	Default: 600604A0 hex	
Size: 4 bytes (U32)		Access: RO	PDO map: Not possible
Sub-index 19: 19th Input Object to be mapped			
Range: -	Unit: -	Default: 600604B0 hex	
Size: 4 bytes (U32)		Access: RO	PDO map: Not possible
Sub-index 20: 20th Input Object to be mapped			
Range: -	Unit: -	Default: 600604C0 hex	
Size: 4 bytes (U32)		Access: RO	PDO map: Not possible

- The object gives the mapping for an application using Vision Sensor functions.
- 6005 hex (Image Processing Results Integer Data)
- 6006 hex (Image Processing Results Real Data)

1A0F hex	16th transmit PDO Mapping		
Sub-index 0: Number of objects			
Range: -	Unit: -	Default: 40 hex	
Size: 1 byte (U8)		Access: RO	PDO map: Not possible
Sub-index 1: 1st Input Object to be mapped			
Range: -	Unit: -	Default: 60050120 hex	
Size: 4 bytes (U32)		Access: RO	PDO map: Not possible
Sub-index 2: 2nd Input Object to be mapped			
Range: -	Unit: -	Default: 60050220 hex	

Size: 4 bytes (U32)	Access: RO	PDO map: Not possible
Sub-index 3: 3rd Input Object to be mapped		
Range: -	Unit: -	Default: 60050320 hex
Size: 4 bytes (U32)	Access: RO	PDO map: Not possible
Sub-index 4: 4th Input Object to be mapped		
Range: -	Unit: -	Default: 60050420 hex
Size: 4 bytes (U32)	Access: RO	PDO map: Not possible
Sub-index 5: 5th Input Object to be mapped		
Range: -	Unit: -	Default: 60060520 hex
Size: 4 bytes (U32)	Access: RO	PDO map: Not possible
Sub-index 6: 6th Input Object to be mapped		
Range: -	Unit: -	Default: 60060620 hex
Size: 4 bytes (U32)	Access: RO	PDO map: Not possible
Sub-index 7: 7th Input Object to be mapped		
Range: -	Unit: -	Default: 60060720 hex
Size: 4 bytes (U32)	Access: RO	PDO map: Not possible
Sub-index 8: 8th Input Object to be mapped		
Range: -	Unit: -	Default: 60060820 hex
Size: 4 bytes (U32)	Access: RO	PDO map: Not possible
Sub-index 9: 9th Input Object to be mapped		
Range: -	Unit: -	Default: 60060920 hex
Size: 4 bytes (U32)	Access: RO	PDO map: Not possible
Sub-index 10: 10th Input Object to be mapped		
Range: -	Unit: -	Default: 60060A20 hex
Size: 4 bytes (U32)	Access: RO	PDO map: Not possible
Sub-index 11: 11th Input Object to be mapped		
Range: -	Unit: -	Default: 60060B20 hex
Size: 4 bytes (U32)	Access: RO	PDO map: Not possible
Sub-index 12: 12th Input Object to be mapped		
Range: -	Unit: -	Default: 60060C20 hex
Size: 4 bytes (U32)	Access: RO	PDO map: Not possible
Sub-index 13: 13th Input Object to be mapped		
Range: -	Unit: -	Default: 60060D20 hex
Size: 4 bytes (U32)	Access: RO	PDO map: Not possible
Sub-index 14: 14th Input Object to be mapped		
Range: -	Unit: -	Default: 60060E20 hex
Size: 4 bytes (U32)	Access: RO	PDO map: Not possible
Sub-index 15: 15th Input Object to be mapped		
Range: -	Unit: -	Default: 60060F20 hex
Size: 4 bytes (U32)	Access: RO	PDO map: Not possible
Sub-index 16: 16th Input Object to be mapped		
Range: -	Unit: -	Default: 60061020 hex
Size: 4 bytes (U32)	Access: RO	PDO map: Not possible
Sub-index 17: 17th Input Object to be mapped		
Range: -	Unit: -	Default: 60060140 hex
Size: 4 bytes (U32)	Access: RO	PDO map: Not possible
Sub-index 18: 18th Input Object to be mapped		
Range: -	Unit: -	Default: 60060240 hex

Size: 4 bytes (U32)	Access: RO	PDO map: Not possible
Sub-index 19: 19th Input Object to be mapped		
Range: -	Unit: -	Default: 60060340 hex
Size: 4 bytes (U32)	Access: RO	PDO map: Not possible
Sub-index 20: 20th Input Object to be mapped		
Range: -	Unit: -	Default: 60060440 hex
Size: 4 bytes (U32)	Access: RO	PDO map: Not possible
Sub-index 21: 21st Input Object to be mapped		
Range: -	Unit: -	Default: 60060540 hex
Size: 4 bytes (U32)	Access: RO	PDO map: Not possible
Sub-index 22: 22nd Input Object to be mapped		
Range: -	Unit: -	Default: 60060640 hex
Size: 4 bytes (U32)	Access: RO	PDO map: Not possible
Sub-index 23: 23rd Input Object to be mapped		
Range: -	Unit: -	Default: 60060740 hex
Size: 4 bytes (U32)	Access: RO	PDO map: Not possible
Sub-index 24: 24th Input Object to be mapped		
Range: -	Unit: -	Default: 60060840 hex
Size: 4 bytes (U32)	Access: RO	PDO map: Not possible
Sub-index 25: 25th Input Object to be mapped		
Range: -	Unit: -	Default: 60060940 hex
Size: 4 bytes (U32)	Access: RO	PDO map: Not possible
Sub-index 26: 26th Input Object to be mapped		
Range: -	Unit: -	Default: 60060A40 hex
Size: 4 bytes (U32)	Access: RO	PDO map: Not possible
Sub-index 27: 27th Input Object to be mapped		
Range: -	Unit: -	Default: 60060B40 hex
Size: 4 bytes (U32)	Access: RO	PDO map: Not possible
Sub-index 28: 28th Input Object to be mapped		
Range: -	Unit: -	Default: 60060C40 hex
Size: 4 bytes (U32)	Access: RO	PDO map: Not possible
Sub-index 29: 29th Input Object to be mapped		
Range: -	Unit: -	Default: 60060D40 hex
Size: 4 bytes (U32)	Access: RO	PDO map: Not possible
Sub-index 30: 30th Input Object to be mapped		
Range: -	Unit: -	Default: 60060E40 hex
Size: 4 bytes (U32)	Access: RO	PDO map: Not possible
Sub-index 31: 31st Input Object to be mapped		
Range: -	Unit: -	Default: 60060F40 hex
Size: 4 bytes (U32)	Access: RO	PDO map: Not possible
Sub-index 32: 32nd Input Object to be mapped		
Range: -	Unit: -	Default: 60061040 hex
Size: 4 bytes (U32)	Access: RO	PDO map: Not possible
Sub-index 33: 33rd Input Object to be mapped		
Range: -	Unit: -	Default: 60061140 hex
Size: 4 bytes (U32)	Access: RO	PDO map: Not possible
Sub-index 34: 34th Input Object to be mapped		
Range: -	Unit: -	Default: 60061240 hex

Size: 4 bytes (U32)	Access: RO	PDO map: Not possible
Sub-index 35: 35th Input Object to be mapped		
Range: -	Unit: -	Default: 60061340 hex
Size: 4 bytes (U32)	Access: RO	PDO map: Not possible
Sub-index 36: 36th Input Object to be mapped		
Range: -	Unit: -	Default: 60061440 hex
Size: 4 bytes (U32)	Access: RO	PDO map: Not possible
Sub-index 37: 37th Input Object to be mapped		
Range: -	Unit: -	Default: 60061540 hex
Size: 4 bytes (U32)	Access: RO	PDO map: Not possible
Sub-index 38: 38th Input Object to be mapped		
Range: -	Unit: -	Default: 60061640 hex
Size: 4 bytes (U32)	Access: RO	PDO map: Not possible
Sub-index 39: 39th Input Object to be mapped		
Range: -	Unit: -	Default: 60061740 hex
Size: 4 bytes (U32)	Access: RO	PDO map: Not possible
Sub-index 40: 40th Input Object to be mapped		
Range: -	Unit: -	Default: 60061840 hex
Size: 4 bytes (U32)	Access: RO	PDO map: Not possible

- The object gives the mapping for an application using Vision Sensor functions.
- 6005 hex (Image Processing Results Integer Data)
- 6006 hex (Image Processing Results Real Data)

In multiple-line used, objects have been prepared for each line as shown below.

- Line 1: 1A20 hex (1st transmit PDO Mapping), 1A21 hex to 1A2F hex (2nd to 16th transmit PDO Mapping)
- Line 2: 1A40 hex (1st transmit PDO mapping) and 1A41 hex to 1A4F hex (2nd to 16th transmit PDO mapping)
- Line 3: 1A60 hex (1st transmit PDO mapping) and 1A61 hex to 1A6F hex (2nd to 16th transmit PDO mapping)
- Line 4: 1A80 hex (1st transmit PDO Mapping), 1A81 hex to 1A8F hex (2nd to 16th transmit PDO Mapping)
- Line 5: 1AA0 hex (1st transmit PDO Mapping), 1AA1 hex to 1AAF hex (2nd to 16th transmit PDO Mapping)
- Line 6: 1AC0 hex (1st transmit PDO mapping) and 1AC1 hex to 1ACF hex (2nd to 16th transmit PDO mapping)
- Line 7: 1AE0 hex (1st transmit PDO Mapping), 1AE1 hex to 1AEF hex (2nd to 16th transmit PDO Mapping)

1A10 hex	17th transmit PDO Mapping	
Sub-index 0: Number of objects		
Range: -	Unit: -	Default: 06 hex
Size: 1 byte (U8)	Access: RO	PDO map: Not possible
Sub-index 1: 1st Input Object to be mapped		
Range: -	Unit: -	Default: 60070120 hex
Size: 4 byte (U32)	Access: RO	PDO map: Not possible
Sub-index 2: 2nd Input Object to be mapped		
Range: -	Unit: -	Default: 60070220 hex
Size: 4 bytes (U32)	Access: RO	PDO map: Not possible
Sub-index 3: 3rd Input Object to be mapped		
Range: -	Unit: -	Default: 60070320 hex

Size: 4 bytes (U32)	Access: RO	PDO map: Not possible
Sub-index 4: 4th Input Object to be mapped		
Range: -	Unit: -	Default: 60070420 hex
Size: 4 bytes (U32)	Access: RO	PDO map: Not possible
Sub-index 5: 5th Input Object to be mapped		
Range: -	Unit: -	Default: 60070540 hex
Size: 4 bytes (U32)	Access: RO	PDO map: Not possible
Sub-index 6: 6th Input Object to be mapped		
Range: -	Unit: -	Default: 60070640 hex
Size: 4 bytes (U32)	Access: RO	PDO map: Not possible

- The object gives the mapping for an application using Vision Sensor functions.
- 6005 hex (Image Processing Results Integer Data)
- 6006 hex (Image Processing Results Real Data)
- 6007 hex (User Output Area)

In multiple-line used, objects have been prepared for each line as shown below.

Line 1:	1A20 hex (1st transmit PDO Mapping), 1A21 hex to 1A30 hex (2nd to 17th transmit PDO Mapping)
Line2:	1A40 hex (1st transmit PDO Mapping), 1A41 hex to 1A50 hex (2nd to 17th transmit PDO Mapping)
Line 3:	1A60 hex (1st transmit PDO mapping) and 1A61 hex to 1A70 hex (2nd to 17th transmit PDO mapping)
Line 4:	1A80 hex (1st transmit PDO Mapping), 1A81 hex to 1A90 hex (2nd to 17th transmit PDO Mapping)
Line 5:	1AA0 hex (1st transmit PDO Mapping), 1AA1 hex to 1AB0 hex (2nd to 17th transmit PDO Mapping)
Line 6:	1AC0 hex (1st transmit PDO mapping) and 1AC1 hex to 1AD0 hex (2nd to 17th transmit PDO mapping)
Line 7:	1AE0 hex (1st transmit PDO Mapping), 1AE1 hex to 1AF0 hex (2nd to 17th transmit PDO Mapping)

1BFF hex	512th transmit PDO Mapping		
Sub-index 0: Number of objects			
Range: -	Unit: -	Default: 01 hex	Attribute: -
Size: 1 byte (U8)	Access: RO	PDO map: Not possible	
Sub-index 1: 1st Input Object to be mapped			
Range: -	Unit: -	Default: 20020108 hex	Attribute: -
Size: 4 byte (U32)	Access: RO	PDO map: Not possible	

- This object gives the mapping for notification of errors that are detected in the Slave Unit.
- The mapping includes 2002 hex - 01 hex: Sysmac Error Status.
- When a Machine Automation Controller of the NJ series are connected, 1C13 hex: Sync manager 3 PDO assignment is assigned to this object. This object is automatically assigned in the default settings of Sysmac Studio.

Sync Manager Communication Objects

The communication memory for EtherCAT is set by the objects from 1C00 hex to 1C13 hex.

1C00 hex	Sync Manager Communication Type		
Sub-index 0: Number of used Sync Manager channels			
Range: -	Unit: -	Default: 04 hex	Attribute: -

Size: 1 byte (U8)	Access: RO	PDO map: Not possible
Sub-index 1: Communication Type Sync Manager 0		
Range: -	Unit: -	Default: 01 hex
Attribute: -		
Size: 4 bytes (U8)	Access: RO	PDO map: Not possible
Sub-index 2: Communication Type Sync Manager 1		
Range: -	Unit: -	Default: 02 hex
Attribute: -		
Size: 4 bytes (U8)	Access: RO	PDO map: Not possible
Sub-index 3: Communication Type Sync Manager 2		
Range: -	Unit: -	Default: 03 hex
Attribute: -		
Size: 4 bytes (U8)	Access: RO	PDO map: Not possible
Sub-index 4: Communication Type Sync Manager 3		
Range: -	Unit: -	Default: 04 hex
Attribute: -		
Size: 4 bytes (U8)	Access: RO	PDO map: Not possible

The sync manager has the following settings.

- SM0: Mailbox reception (EtherCAT Master Unit to Slave Unit)
- SM1: Mailbox transmit (EtherCAT Slave Unit to Master Unit)
- SM2: Process data output (EtherCAT Master Unit to Slave Unit)
- SM3: Process data input (EtherCAT Slave Unit to Master Unit)

1C10 hex	Sync manager 0 PDO Assignment		
Sub-index 0: Number of assigned PDOs			
Range: 00 hex	Unit: -	Default: 00 hex	Attribute: -
Size: 1 byte (U8)	Access: RO	PDO map: Not possible	

- This indicates the number of PDO mappings used by this sync manager.
- Mailbox reception sync manager does not have PDOs.

1C11 hex	Sync manager 1 PDO Assignment		
Sub-index 0: Number of assigned PDOs			
Range: 00 hex	Unit: -	Default: 00 hex	Attribute: -
Size: 1 byte (U8)	Access: RO	PDO map: Not possible	

- This indicates the number of PDO mappings used by this sync manager.
- Mailbox transmit sync manager does not have PDOs.

1C12 hex	Sync manager 2 PDO Assignment		
Sub-index 0: Number of assigned PDOs			
Range: -	Unit: -	Default: 02 hex	Attribute: -
Size: 1 byte (U8)	Access: RW ^{*1}	PDO map: Not possible	
Sub-index 1 to 2: 1st to 2nd PDO Mapping Object Index of assigned PDO			
Range: -	Unit: -	Default: by Slave Unit type	Attribute: -
Size: 2 bytes (U16)	Access: RW ^{*1}	PDO map: Not possible	

*1. If a receive PDO is not provided, RO is used.

- This indicates the RxPDOs used by this sync manager.

1C13 hex	Sync manager 3 PDO Assignment		
Sub-index 0: Number of assigned PDOs			
Range: -	Unit: -	Default: 05 hex	Attribute: -

Size: 1 byte (U8)	Access: RW*1	PDO map: Not possible	
Sub-index 1 to 5: 1st to 5th PDO Mapping Object Index of assigned PDO			
Range: -	Unit: -	Default: by Slave Unit type	Attribute: -
Size: 2 bytes (U16)	Access: RW*1	PDO map: Not possible	

*1. If a transmit PDO is not provided, RO is used.

- This indicates the TxPDOs used by this sync manager.

Manufacturer Specific Objects

This section describes the CiA401 generic I/O module device profile and the specific objects, implemented in EtherCAT Slave Units for the Sensor Controller.

• Common Objects for Sysmac Devices

Manufacture Specific area 1

2100 hex	Error History Clear		
Range: -	Unit: -	Default: 00000000 hex	Attribute: A
Size: 4 bytes (U32)	Access: RW	PDO map: Not possible	

- This object clears the diagnosis history at 10F3 hex (Diagnosis History).
- It clears history only when a specific value are written. The specific value is *elcl*.

MSB		LSB	
l	c	l	e
6C hex	63 hex	6C hex	65 hex

Writing values other than these is invalid.

2002 hex	Sysmac Error		
Sub-index 0: Number of entries			
Range: -	Unit: -	Default: 02 hex	Attribute: -
Size: 1 byte (U8)	Access: RO	PDO map: Not possible	
Sub-index 1: Sysmac Error Status			
Range: -	Unit: -	Default: 00 hex	Attribute: -
Size: 1 byte (U8)	Access: RW	PDO map: Not possible	
Sub-index 2: Sysmac Error Status Clear			
Range: -	Unit: -	Default: 00 hex	Attribute: A
Size: 1 byte (U8)	Access: RW	PDO map: Not possible	

- This mapping is used to notify and clear Sysmac Error Status.
- Sub-index 1: Sysmac Error Status
 - This object is used to notify errors detected in the Slave Unit.
 - When a Machine Automation Controller of the NJ series are connected, map this object to a PDO.
- Sub-index 2: Sysmac Error Status Clear
 - This object is used by the Controller (a Sysmac Device) to reset errors occurring in Slave Units.



Additional Information

In the default Sysmac Studio settings, sub-index 1 (Sysmac Error Status) is automatically mapped to a PDO because 1BFF hex (512th transmit PDO Mapping) is assigned

2200 hex	Communication Error Setting		
Range: 00 hex to 0F hex	Unit: number of sequences	Default: 01 hex	Attribute: C
Size: 1 byte (U8)	Access: RW	PDO map: Not possible	

- Object implemented only on Slave Units operating in the DC mode.
- The number of consecutive times for detecting communications errors is set with this object.
- The setting range is from 00 hex to 0F hex and the number of detections is *the set number of times + 1*.
- Although the value is rewritable in the DC mode operation, the operation is performed with the value set when the operation is shifting from the pre-operational state to safe-operational state. Note that at this point, the rewritten value is read.



Additional Information

With the default setting of 01 hex, an error is detected if communications errors occur twice in a row.

2201 hex	Sync Not Received Timeout Setting		
Range: 0000 hex to 0258 hex	Unit: s	Default: 0000 hex	Attribute: C
Size: 2 bytes (U16)	Access: RW	PDO map: Not possible	

- Object implemented only on Slave Units operating in the DC mode.
- This object is used to set the standby time until the first synchronization interrupt signal (SYNC0) is input after shifting to the safe-operational state where a DC mode is confirmed.
- If the first interrupt signal (SYNC0) is not input at all within this set time, a synchronization error occurs.
- The setting range is from 0000 hex to 0258 hex (600 [s]) and operation is performed at 120 [s] when 0000 hex is set.
- Although the value is rewritable in the DC mode operation, the operation is performed with the value set when the operation is shifting from the pre-operational state to safe-operational state. Note that at this point, the rewritten value is read.

• Vision Sensor Specific Objects

Manufacturer Specific area 2

6000 hex	Status flag		
Sub-index 0: Number of entries			
Range: -	Unit: -	Default: 00 hex	
Size: 1 byte (U8)	Access: RO	PDO map: Not possible	
Sub-index1: Command Completion Bit			
Range: True (1) or False (0)	Unit: -	Default: False (0)	
Size: 1 bit (BOOL)	Access: RO	PDO map: Possible	
Sub-index 2: BUSY Bit			
Range: True (1) or False (0)	Unit: -	Default: by the status when starting	
Size: 1 bit (BOOL)	Access: RO	PDO map: Possible	
Sub-index 3: Trigger Ready Bit			
Range: True (1) or False (0)	Unit: -	Default: by the status when starting	
Size: 1 bit (BOOL)	Access: RO	PDO map: Possible	
Sub-index 4: Total Judgment Bit			
Range: True (1) or False (0)	Unit: -	Default: False (0)	

Size: 1 bit (BOOL)	Access: RO	PDO map: Possible
Sub-index 5: RUN Mode Bit		
Range: True (1) or False (0)	Unit: -	Default: by the status when starting
Size: 1 bit (BOOL)	Access: RO	PDO map: Possible
Sub-index 6: Trigger Ack Bit		
Range: True (1) or False (0)	Unit: -	Default: by the status when starting
Size: 1 bit (BOOL)	Access: RO	PDO map: Possible
Sub-index 7: Command Ready Bit		
Range: True (1) or False (0)	Unit: -	Default: by the status when starting
Size: 1 bit (BOOL)	Access: RO	PDO map: Possible
Sub-index 8: Shutter Output Bit		
Range: True (1) or False (0)	Unit: -	Default: by the status when starting
Size: 1 bit (BOOL)	Access: RO	PDO map: Possible
Sub-index 9: Flow Command Completion Bit		
Range: True (1) or False (0)	Unit: -	Default: by the status when starting
Size: 1 bit (BOOL)	Access: RO	PDO map: Possible
Sub-index 10: Flow Command Busy Bit		
Range: True (1) or False (0)	Unit: -	Default: by the status when starting
Size: 1 bit (BOOL)	Access: RO	PDO map: Possible
Sub-index 11: Flow Command Wait Bit		
Range: True (1) or False (0)	Unit: -	Default: by the status when starting
Size: 1 bit (BOOL)	Access: RO	PDO map: Possible
Sub-index 12 to 15: Control Reserve Bit 12 to 15		
Range: True (1) or False (0)	Unit: -	Default: False (0)
Size: 1 bit (BOOL)	Access: RO	PDO map: Possible
Sub-index 16: Error Status Bit		
Range: True (1) or False (0)	Unit: -	Default: by the status when starting
Size: 1 bit (BOOL)	Access: RO	PDO map: Possible
Sub-index 17: Result Notification Bit		
Range: True (1) or False (0)	Unit: -	Default: False (0)
Size: 1 bit (BOOL)	Access: RO	PDO map: Possible
Sub-index 18 to 32: Control Reserve Bit 18 to 32		
Range: True (1) or False (0)	Unit: -	Default: False (0)
Size: 1 bit (BOOL)	Access: RO	PDO map: Possible

- This object is used to get the status of the Sensor Controller.
- Command Completion bit: ON during command execution.
- BUSY bit: ON during command or measurement execution.
- Trigger Ready bit: ON when Trigger signal can be input.
- Overall Judgment bit: ON when the overall judgment is NG.
- Run Mode bit: The signal turns ON when the Sensor Controller is in Run mode (In a measurement capable state with *RUN signal output* checked in the Layout settings for the currently displayed line).
- Trigger Ack bit: The signal turns ON when the Sensor Controller receives the Trigger signal.
- Command Ready bit: ON when a control command can be executed.
- Shutter Output bit: ON when the imaging elements have completed exposure.
- Flow Command Completion bit: ON when execution of a command that was executed during execution of PLC Link, Fieldbus, or normal flow control has been completed.

- Flow Command Busy bit: ON during execution of a command that was input during execution of PLC Link, Fieldbus, or normal flow control.
- Flow Command Wait bit: ON while waiting for command input during execution of PLC Link, Fieldbus, normal flow control.
- Error Status bit: ON when the Sensor Controller has detected an error.
- Result Notification bit: ON when the Sensor Controller completes data output.
- When you use the Sysmac Studio, the sub-index 1 including the above all bits is mapped.

6001 hex	Command Code Echo Back		
Range: -	Unit: -	Default: 00000000 hex	
Size: 4 bytes (U32)	Access: RO	PDO map: Possible	

- The executed command code is stored.

6002 hex	Response Code		
Range: -	Unit: -	Default: 00000000 hex	
Size: 4 bytes (U32)	Access: RO	PDO map: Possible	

- The command execution results are stored. (OK: 00000000 hex, NG: FFFFFFFF hex)

6003 hex	Response Data		
Sub-index 0: Number of entries			
Range: -	Unit: -	Default: 01 hex	
Size: 1 byte (U8)	Access: RO	PDO map: Not possible	
Sub-index 1: Response Data			
Range: -	Unit: -	Default: 00000000 hex	
Size: 4 bytes (BOOL)	Access: RO	PDO map: Possible	

- The response data of results from command execution are stored. (E.g.: The scene number is stored when the command "Get scene number" is performed.)

6004 hex	Error Code		
Range: -	Unit: -	Default: 00000000 hex	
Size: 4 bytes (U32)	Access: RO	PDO map: Possible	

6005 hex	DINT Result Data		
Sub-index 0: Number of entries			
Range: -	Unit: -	Default: 00 hex	
Size: 1 byte (U8)	Access: RO	PDO map: Not possible	
Sub-index 1 to 64: DINT Result Data 0-63			
Range: -	Unit: -	Default: 00000000 hex	
Size: 4 bytes (BOOL)	Access: RO	PDO map: Possible	

- The output data is stored.

6006 hex	LREAL Result Data		
Sub-index 0: Number of entries			
Range: -	Unit: -	Default: 00 hex	
Size: 1 byte (U8)	Access: RO	PDO map: Not possible	
Sub-index 1 to 32: LREAL Result Data 0-31)			
Range: -	Unit: -	Default: 00000000 hex	

Size: 8 bytes (U8)	Access: RO	PDO map: Possible
--------------------	------------	-------------------

- The output data is stored.

6007 hex	User Output Area	
Sub-index 0: Number of entries		
Range: -	Unit: -	Default: 00 hex
Size: 1 byte (U8)	Access: RO	PDO map: Not possible
Sub-index 1: User Output Area 0		
Range: -	Unit: -	Default: 00000000 hex
Size: 4 bytes (INT32)	Access: RO	PDO map: Possible
Sub-index 2: User Output Area 1		
Range: -	Unit: -	Default: 00000000 hex
Size: 4 bytes (INT32)	Access: RO	PDO map: Possible
Sub-index 3: User Output Area 2		
Range: -	Unit: -	Default: 00000000 hex
Size: 4 bytes (INT32)	Access: RO	PDO map: Possible
Sub-index 4: User Output Area 3		
Range: -	Unit: -	Default: 00000000 hex
Size: 4 bytes (INT32)	Access: RO	PDO map: Possible
Sub-index 5: User Output Area 4		
Range: -	Unit: -	Default: 00000000 hex
Size: 4 bytes (INT32)	Access: RO	PDO map: Possible
Sub-index 6: User Output Area 5		
Range: -	Unit: -	Default: 00000000 hex
Size: 4 bytes (INT32)	Access: RO	PDO map: Possible

- The User Output Area is stored.

7000 hex	Control Flag	
Sub-index 0: Number of entries		
Range: -	Unit: -	Default: 00 hex
Size: 1 byte (U8)	Access: RO	PDO map: Not possible
Sub-index 1: Command Request Bit		
Range: True (1) or False (0)	Unit: -	Default: False (0)
Size: 1 bit (BOOL)	Access: RW	PDO map: Possible
Sub-index 2: Trigger Bit		
Range: True (1) or False (0)	Unit: -	Default: False (0)
Size: 1 bit (BOOL)	Access: RW	PDO map: Possible
Sub-index 3 to 8: Control Reserve Bit 3 to 8		
Range: True (1) or False (0)	Unit: -	Default: False (0)
Size: 1 bit (BOOL)	Access: RW	PDO map: Possible
Sub-index 9: Flow Command Request Bit		
Range: True (1) or False (0)	Unit: -	Default: False (0)
Size: 1 bit (BOOL)	Access: RW	PDO map: Possible
Sub-index 10 to 15: Control Reserve Bit 10 to 15		
Range: True (1) or False (0)	Unit: -	Default: False (0)
Size: 1 bit (BOOL)	Access: RW	PDO map: Possible
Sub-index 16: Error Clear Bit		

Range: True (1) or False (0)	Unit: -	Default: False (0)
Size: 1 bit (BOOL)	Access: RW	PDO map: Possible
Sub-index 17: Result Set Request Bit		
Range: True (1) or False (0)	Unit: -	Default: False (0)
Size: 1 bit (BOOL)	Access: RW	PDO map: Possible
Sub-index 18 to 32: Control Reserve Bit 18 to 32		
Range: True (1) or False (0)	Unit: -	Default: False (0)
Size: 1 bit (BOOL)	Access: RW	PDO map: Possible

- This object controls the Sensor Controller.
- Command Request bit: Turned ON to execute a command.
- Trigger bit: Turned ON to execute a measurement.
- Flow Command Request bit: Turned ON to execute a command during execution of PLC Link, Fieldbus, or normal flow control.
- Error Clear bit: Turned ON to clear the Error Status bit (3001 hex, sub-index 17).
- Result Set Request bit: Turned ON to request data output.
- When you use the Sysmac Studio, the sub-index 1 including the above all bits are mapped.

7001 hex	Command Code	
Range: -	Unit: -	Default: 00000000 hex
Size: 4 bytes (BOOL)	Access: RW	PDO map: Possible

- A command code such as *Switch Scene* is stored.

7002 hex	Command parameter	
Sub-index 0: Number of entries		
Range: -	Unit: -	Default: 00 hex
Size: 1 byte (U8)	Access: RO	PDO map: Not possible
Sub-index 1: Command Parameter 0		
Range: -	Unit: -	Default: 00000000 hex
Size: 4 bytes (INT32)	Access: RW	PDO map: Possible
Sub-index 2: Command Parameter 1		
Range: -	Unit: -	Default: 00000000 hex
Size: 4 bytes (INT32)	Access: RW	PDO map: Possible
Sub-index 3: Command Parameter 2		
Range: -	Unit: -	Default: 00000000 hex
Size: 4 bytes (INT32)	Access: RW	PDO map: Possible
Sub-index 4: Command Parameter 3		
Range: -	Unit: -	Default: 00000000 hex
Size: 4 bytes (INT32)	Access: RW	PDO map: Possible

- The command parameter is stored. (E.g. The scene number is stored when the command “Switch scene” is performed.)



Precautions for Correct Use

Since Command Parameter 3 is the reserved area, it is unavailable. Use Command Parameter 0 to 2.

7003 hex	User Input Area
----------	-----------------

Sub-index 0: Number of entries			
Range: -	Unit: -	Default: 00 hex	
Size: 1 byte (U8)	Access: RO	PDO map: Not possible	
Sub-index 1: User Input Area 0			
Range: -	Unit: -	Default: 00000000 hex	
Size: 4 bytes (INT32)	Access: RW	PDO map: Possible	
Sub-index 2: User Input Area 1			
Range: -	Unit: -	Default: 00000000 hex	
Size: 4 bytes (INT32)	Access: RW	PDO map: Possible	
Sub-index 3: User Input Area 2			
Range: -	Unit: -	Default: 00000000 hex	
Size: 4 bytes (INT32)	Access: RW	PDO map: Possible	
Sub-index 4: User Input Area 3			
Range: -	Unit: -	Default: 00000000 hex	
Size: 4 bytes (INT32)	Access: RW	PDO map: Possible	
Sub-index 5: User Input Area 4			
Range: -	Unit: -	Default: 00000000 hex	
Size: 8 bytes (U8)	Access: RW	PDO map: Possible	
Sub-index 6: User Input Area 5			
Range: -	Unit: -	Default: 00000000 hex	
Size: 8 bytes (U8)	Access: RW	PDO map: Possible	

- The User Input Area is stored.

8000 hex	Image Processing Results Output		
Sub-index 0: Number of entries			
Range: -	Unit: -	Default: 03 hex	
Size: 1 byte (U8)	Access: RO	PDO map: Not possible	
Sub-index 1: Switch of handshake mode			
Range: -	Unit: -	Default: 00 hex	
Size: 1 bit (BOOL)	Access: RW	PDO map: Possible	
Sub-index2: Result Valid period			
Range: -	Unit: -	Default: 02 hex	
Size: 4 bytes (INT32)	Access: RW	PDO map: Possible	
Sub-index 3: Result Notification Time			
Range: -	Unit: -	Default: 01 hex	
Size: 4 bytes (INT32)	Access: RW	PDO map: Possible	

In multiple-line used, objects have been prepared for each line as shown below.

- Line 1 : 6010 hex (Status Signals) to 6016 hex (Image Processing Results Real Number Data)
7010 hex (Control Signals) to 7012 hex (Command Parameter)
8010 hex (Image Processing Results Output Settings)
- Line 2 : 6020 hex (Status Signals) to 6026 hex (Image Processing Results Real Number Data)
7020 hex (Control Signals) to 7022 hex (Command Parameter)
8020 hex (Image Processing Results Output Settings)
- Line 3 : 6030 hex (Status Signals) to 6036 hex (Image Processing Results Real Number Data)
7030 hex (Control Signals) to 7032 hex (Command Parameter)
8030 hex (Image Processing Results Output Settings)

- Line 4 : 6040 hex (Status Signals) to 6046 hex (Image Processing Results Real Number Data)
7040 hex (Control Signals) to 7042 hex (Command Parameter)
8040 hex (Image Processing Results Output Settings)
- Line 5 : 6050 hex (Status Signals) to 6056 hex (Image Processing Results Real Number Data)
7050 hex (Control Signals) to 7052 hex (Command Parameter)
8050 hex (Image Processing Results Output Settings)
- Line 6 : 6060 hex (Status Signals) to 6066 hex (Image Processing Results Real Number Data)
7060 hex (Control Signals) to 7062 hex (Command Parameter)
8060 hex (Image Processing Results Output Settings)
- Line 7 : 6070 hex (Status Signals) to 6076 hex (Image Processing Results Real Number Data)
7070 hex (Control Signals) to 7072 hex (Command Parameter)
8070 hex (Image Processing Results Output Settings)

F000 hex	Modular Device Profile		
Sub-index 0: Number of entries			
Range: -	Unit: -	Default: 05 hex	
Size: 1 byte (U8)	Access: RO	PDO map: Not possible	
Sub-index 1: Index distance			
Range: -	Unit: -	Default: 10 hex	
Size: 2 bytes (U16)	Access: RO	PDO map: Not possible	
Sub-index 2: Maximum number of modules			
Range: -	Unit: -	Default: 08 hex	
Size: 2 bytes (U16)	Access: RO	PDO map: Not possible	
Sub-index 3: General configuration			
Range: -	Unit: -	Default: 00 hex	
Size: 4 bytes (U32)	Access: RO	PDO map: Not possible	
Sub-index 4: General information			
Range: -	Unit: -	Default: 00 hex	
Size: 4 bytes (U32)	Access: RO	PDO map: Not possible	
Sub-index 5: Module PDO Group of device			
Range: -	Unit: -	Default: 00 hex	
Size: 2 bytes (U16)	Access: RO	PDO map: Not possible	

F010 hex	Module Profile List		
Sub-index 0: Number of entries			
Range: -	Unit: -	Default: 08 hex	
Size: 1 byte (U8)	Access: RO	PDO map: Not possible	
Sub-index 1: Profile information of the module on position 1			
Range: -	Unit: -	Default: 00 hex	
Size: 4 bytes (U32)	Access: RO	PDO map: Not possible	
Sub-index 2: Profile information of the module on position 2			
Range: -	Unit: -	Default: 00 hex	
Size: 4 bytes (U32)	Access: RO	PDO map: Not possible	
Sub-index 3: Profile information of the module on position 3			
Range: -	Unit: -	Default: 00 hex	
Size: 4 bytes (U32)	Access: RO	PDO map: Not possible	
Sub-index 4: Profile information of the module on position 4			
Range: -	Unit: -	Default: 00 hex	
Size: 4 bytes (U32)	Access: RO	PDO map: Not possible	

Sub-index 5: Profile information of the module on position 5			
Range: -	Unit: -	Default: 00 hex	
Size: 4 bytes (U32)		Access: RO	PDO map: Not possible
Sub-index 6: Profile information of the module on position 6			
Range: -	Unit: -	Default: 00 hex	
Size: 4 bytes (U32)		Access: RO	PDO map: Not possible
Sub-index 7: Profile information of the module on position 7			
Range: -	Unit: -	Default: 00 hex	
Size: 4 bytes (U32)		Access: RO	PDO map: Not possible
Sub-index 8: Profile information of the module on position 8			
Range: -	Unit: -	Default: 00 hex	
Size: 4 bytes (U32)		Access: RO	PDO map: Not possible

F030 hex	Configured Module Ident List1		
Sub-index 0: Number of entries			
Range: -	Unit: -	Default: 08 hex	
Size: 1 byte (U8)		Access: RO	PDO map: Not possible
Sub-index 1: Module Ident of the module configured on position 1			
Range: -	Unit: -	Default: 00 hex	
Size: 4 bytes (U32)		Access: RW	PDO map: Not possible
Sub-index 2: Module Ident of the module configured on position 2			
Range: -	Unit: -	Default: 00 hex	
Size: 4 bytes (U32)		Access: RW	PDO map: Not possible
Sub-index 3: Module Ident of the module configured on position 3			
Range: -	Unit: -	Default: 00 hex	
Size: 4 bytes (U32)		Access: RW	PDO map: Not possible
Sub-index 4: Module Ident of the module configured on position 4			
Range: -	Unit: -	Default: 00 hex	
Size: 4 bytes (U32)		Access: RW	PDO map: Not possible
Sub-index 5: Module Ident of the module configured on position 5			
Range: -	Unit: -	Default: 00 hex	
Size: 4 bytes (U32)		Access: RW	PDO map: Not possible
Sub-index 6: Module Ident of the module configured on position 6			
Range: -	Unit: -	Default: 00 hex	
Size: 4 bytes (U32)		Access: RW	PDO map: Not possible
Sub-index 7: Module Ident of the module configured on position 7			
Range: -	Unit: -	Default: 00 hex	
Size: 4 bytes (U32)		Access: RW	PDO map: Not possible
Sub-index 8: Module Ident of the module configured on position 8			
Range: -	Unit: -	Default: 00 hex	
Size: 4 bytes (U32)		Access: RW	PDO map: Not possible

F050 hex	Detected Module Ident List1		
Sub-index 0: Number of entries			
Range: -	Unit: -	Default: 08 hex	
Size: 1 byte (U8)		Access: RO	PDO map: Not possible
Sub-index 1: Module Ident of the module configured on position 1			
Range: -	Unit: -	Default: 00 hex	

Size: 4 bytes (U32)	Access: RO	PDO map: Not possible
Sub-index 2: Module Ident of the module configured on position 2		
Range: -	Unit: -	Default: 00 hex
Size: 4 bytes (U32)	Access: RO	PDO map: Not possible
Sub-index 3: Module Ident of the module configured on position 3		
Range: -	Unit: -	Default: 00 hex
Size: 4 bytes (U32)	Access: RO	PDO map: Not possible
Sub-index 4: Module Ident of the module configured on position 4		
Range: -	Unit: -	Default: 00 hex
Size: 4 bytes (U32)	Access: RO	PDO map: Not possible
Sub-index 5: Module Ident of the module configured on position 5		
Range: -	Unit: -	Default: 00 hex
Size: 4 bytes (U32)	Access: RO	PDO map: Not possible
Sub-index 6: Module Ident of the module configured on position 6		
Range: -	Unit: -	Default: 00 hex
Size: 4 bytes (U32)	Access: RO	PDO map: Not possible
Sub-index 7: Module Ident of the module configured on position 7		
Range: -	Unit: -	Default: 00 hex
Size: 4 bytes (U32)	Access: RO	PDO map: Not possible
Sub-index 8: Module Ident of the module configured on position 8		
Range: -	Unit: -	Default: 00 hex
Size: 4 bytes (U32)	Access: RO	PDO map: Not possible

2-2 Communicating by PLC Link

This section describes the communication settings, communication specifications (PLC I/O memory areas and communication commands used in PLC communications), and timing charts during communications, which are required for PLC Link communications between the Sensor Controller and an external device.

2-2-1 Communications Processing Flow

The Sensor Controller communicates with external devices using Ethernet or RS-232C through PLC Link communications.

In Ethernet communications, PLC uses UDP/IP or TCP/IP protocol in PLC Link.



Precautions for Correct Use

- PLC Link communications can be performed via Ethernet or RS-232C, but not both at the same time.
- The Sensor Controller will be a client when you connect with PLC Link via TCP/IP protocol.
- Multiple Sensor Controllers and multiple lines cannot be connected with UDP/IP communications. For multiple Sensor Controllers, or multiple lines, use TCP/IP.
- Do not duplicate settings of FINS/UDP ports in CJ/NJ series to the Sensor Controller Output port number when you use UDP/IP communication to connect OMRON PLC CJ series or NJ/NX series via Ethernet.
- If you connect multiple Sensor Controllers to a FINS/UDP port, PLC communication may be disabled. A PLC link error may occur.
- When PLC CJ series or Machine Automation Controllers of the NJ/NX series produced by OMRON are connected to the Sensor Controllers, use TCP. If you used UDP, PLC Link communications will not be established properly and a PLC Link error may occur.

PLC Link communications allow the PLC to use command and response control method, and data output method after measurements. (Both methods can be performed at once.)

In PLC Link communications, the following three communication areas are set in the PLC.

Command/response method	(1) Command Area	This area is used that you write control commands to perform for the Sensor Controller.
	(2) Response Area	This area is used to read the performed results of the control commands written in the Command Area.
Data output after measurement	(3) Data Output Area	This area is used to read the data output after measurement was performed.

The above three communication areas are assigned to the PLC's I/O memory by setting the *area type* and *address* during setting the communication specifications for the Sensor Controller.

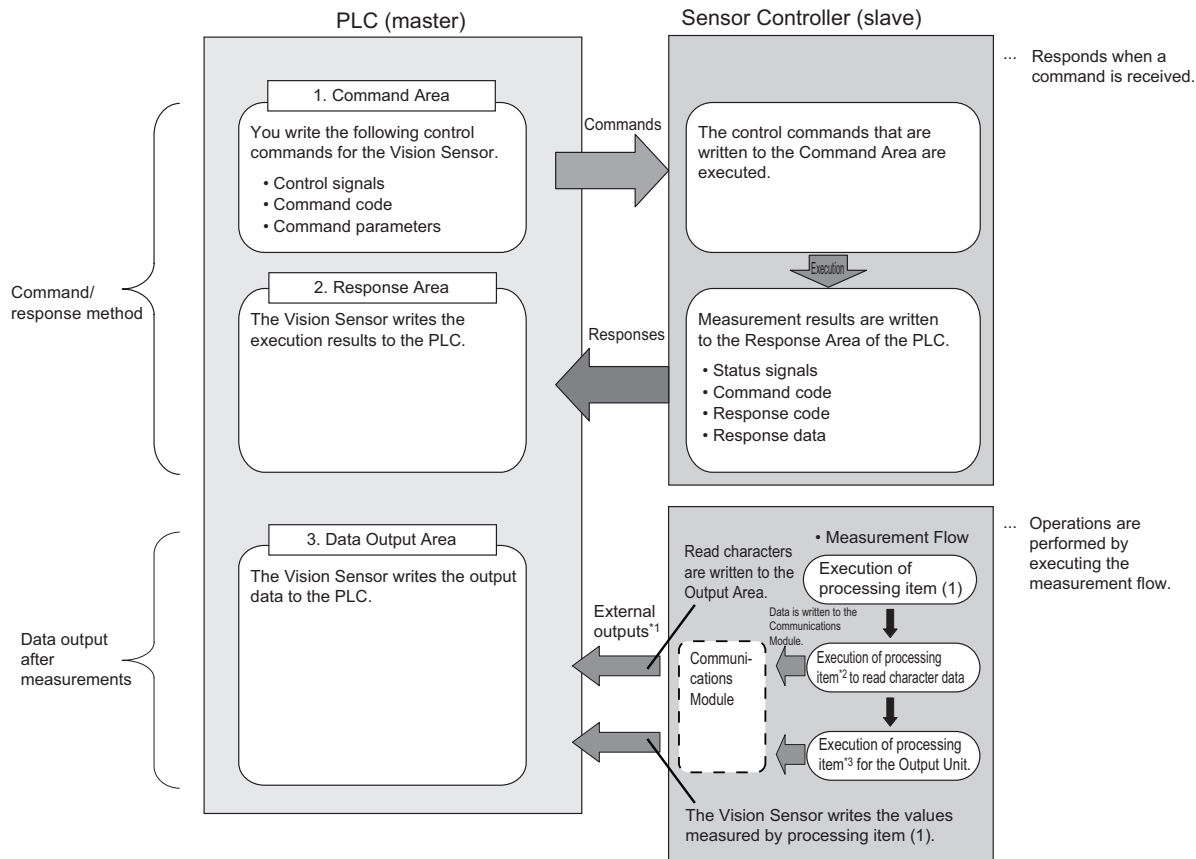

- *1 : You can use output controls (handshaking) to prevent output data from being externally output from the communications buffer until the Controller (master) turns ON the Result Set Request (DSA) signal to request the output data.
- *2 : The following processing items are used to read characters:
Character inspection, Barcode, 2Dcode, and OCR
- *3 : For details of the Output Units outputting measurement data, refer to *Settings Required for Data Output* on page 1-20.



Additional Information

The PLC Link protocol communicates using three link areas: Command Area, Response Area, and Data Output Area. It is different from the serial PLC Link protocol used to inter-connect OMRON PLCs serially.



Precautions for Correct Use

In the default settings for PLC Link communications, the data output processing method is set to the same processing used for models prior to the FZ4 series. This setting synchronizes the measurement processing and data output processing so that all data output processing finishes when measurement finishes. However, this makes the overall processing time for the measurement flow longer. If required for your application, change the communications settings to *Asynchronous Output* mode, which performs measurement processing and data output processing in parallel. For details, refer to *Asynchronous Output* on page 2-154.

2-2-2 Communications Settings

The following settings are required to use PLC Link.

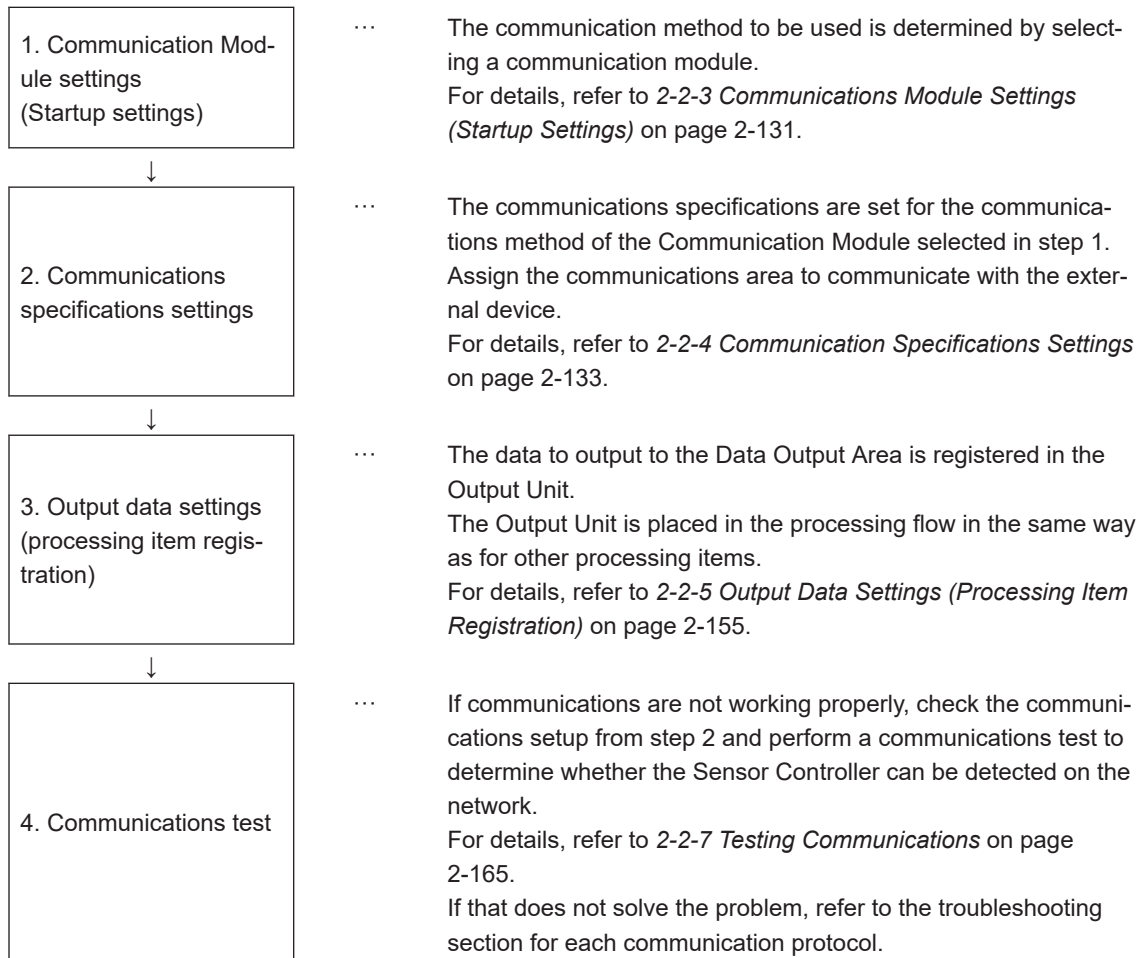

2-2-3 Communications Module Settings (Startup Settings)

The communication method used for communication with the Sensor Controller is selected from the communication modules.

- 1 On the Main window, click **Tool - System Settings** to open the system settings.
- 2 On the Multiview Explorer on the left, select **System settings - Startup - Startup setting** and then click the **Communication** tab.

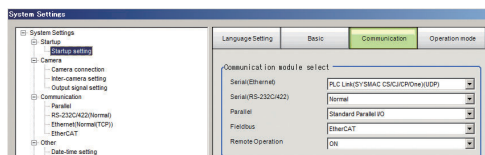

- 3 Select one of the following Communication Modules based on the communication method used to connect with the Sensor Controller and the Unit to be connected, and then click **Apply**.

Communications Module	Description
Serial (Ethernet)	Performs PLC Link communications via an Ethernet connection.
PLC Link (SYMAC CS/CJ/CP/One) (UDP)	Select this communication module to communicate with an OM-RON PLC using the UDP communication protocol.
PLC Link (SYMAC CS/CJ/CP/One) (TCP)	Select this communication module to communicate with an OM-RON PLC using the TCP communication protocol.
PLC Link (MELSEC QnU/Q/QnAS) (UDP)	Select this communication module to communicate with a Mitsubishi Electric PLC using the UDP communication protocol.
PLC Link (MELSEC QnU/Q/QnAS) (TCP)	Select this communication module to communicate with a Mitsubishi Electric PLC using the TCP communication protocol.
PLC Link (JEPMC MP)	Select this Communications Module to communicate with a Yaskawa Electric PLC.
Serial (RS-232C/422)	Performs PLC Link communications using an RS-232C/422 connection. *1
PLC Link (SYMAC CS/CJ/CP/One)	Select this communication module to communicate with an OM-RON PLC.
PLC Link (MELSEC QnU/Q/QnAS)	Select this communication module to communicate with a Mitsubishi Electric PLC.

*1. RS-422 is unavailable in the MELSEC Q series and the FH/FHV series.



Additional Information

Normally select UDP communication module when serial is set as Ethernet. Select TCP communication module if that is the recommended method for your particular communication environment.

- 4 Click **Data save** in the Toolbox Pane.

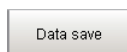

- 5 On the Main window, click **Function - System restart**.

- 6** Click **OK** in the System restart dialog box to restart the Sensor Controller.
When the Sensor Controller was restarted, the set Communication Module will operate with the default settings.
- 7** Set the IP address and other parameters for external devices such as a PLC.



Precautions for Correct Use

After you set the Communication Module, always click **Data save** and then restart the Sensor Controller. If the settings are not saved and the Sensor Controller is not restarted, the new Communication Module settings will not be enabled



Additional Information

You can save the Communication Module settings to a file.
Use the *System data* or *System + Scene group 0 data* option for *saving settings to a file*.
For details, Refer to *Saving Settings Data to the Controller RAM Disk or an External Storage Device* in the *Vision System FH/FHV Series User's Manual (Cat. No. Z365)*.

2-2-4 Communication Specifications Settings

Here, set the communication specifications such as the link areas, baud rate, and data length.

The communication settings are performed for Ethernet and RS-232C separately.

If communications were not established even though the settings have been performed, check the setting details and communication status.

For details, refer to *2-2-7 Testing Communications* on page 2-165.



Precautions for Correct Use

- The settings dialog box for the communication specifications will change depending on the Communication Module that you use.
Before you set the communication specifications, select the Communication Module to use with the Sensor Controller in the startup settings.
For details, refer to *2-2-3 Communications Module Settings (Startup Settings)* on page 2-131.
After you selected the Communication Module, save the settings to the Sensor Controller and restart it.
If you do not restart the Sensor Controller, the selected Communication Module will not be enabled.
- Use the same communication settings for the Sensor Controller and the external device.
- Do not input signals to Ethernet from an external device while setting the Ethernet system settings.

Connecting via Ethernet

- 1** On the Main window, click **Tool - System Settings** to open the system settings.
Select **System Settings** and then select **Communication** → **Ethernet (PLC Link (SYSMAC CS/CJ/CP/One))**, **Ethernet (PLC Link (MELSEC QnU/Q/QnAS))**, or **Ethernet (PLC Link (JEPMC MP))**.
The Ethernet view is displayed.
- 2** In the communication setting area, set each items.
In the case of Ethernet (PLC Link (SYSMAC CS/CJ/CP/One) (UDP)):

Address setting				
<input type="radio"/> Obtain an IP address automatically				
<input checked="" type="radio"/> Use the following IP address				
IP address:	10	5	5	100
Subnet mask:	255	255	255	0
Default gateway:	10	5	5	100
DNS server:	10	5	5	100
Preferred WINS server:	0	0	0	0
Alternate WINS server:	0	0	0	0

Address setting 2				
<input type="radio"/> Obtain an IP address automatically				
<input checked="" type="radio"/> Use the following IP address				
IP address:	10	5	6	100
Subnet mask:	255	255	255	0
Default gateway:	10	5	6	100
DNS server:	10	5	6	100
Preferred WINS server:	0	0	0	0
Alternate WINS server:	0	0	0	0

Input/Output setting				
Output IP address:	0	0	0	0
Input/Output port No.:	9600			



Additional Information

- Sensor Controllers of the FH-2000 / FH-5000 series have two Ethernet ports. Set the settings for the two Ethernet ports as follows:
 - Communication Module Settings:
Use the same settings for both ports
 - IP Address Setting:
Set a different IP address for each Ethernet port.
The IP address for the top Ethernet port is set in *Address setting*, and the IP address for the bottom Ethernet port is set in *Address setting 2*. Note that the Sensor Controller prioritizes the bottom port, so when there is a high network load, communication on the top port may be delayed or in some cases communication data may be lost. By using both Ethernet ports simultaneously, you can use the bottom port for PLC Link, Non-procedure, EtherNet/IP, or PROFINET communications with an external device such as a PLC and the top port for FTP or remote operation communications with an external device.
- The following Sensor Controller type has one Ethernet port:
 - FH-L/FHV series
In this case, the IP address of the Ethernet port is set in *Address setting 2*

Setting item	Setting value [Factory default]	Description
Address Settings Address Settings is only for the following series: FH-2000 / FH-5000 series		Set the IP address for the upper Ethernet port on the Sensor Controller.
	<ul style="list-style-type: none"> Obtain an IP address automatically. [Use the following IP address] 	Set the IP address for the Sensor Controller. When <i>Obtain an IP address automatically</i> is selected, the IP address of the Sensor Controller will be automatically obtained. When <i>Use the following IP address</i> is selected, set the IP address, subnet mask, and the default gateway address.
IP Address	a.b.c.d a: 1 to 223 b: 0 to 255 c: 0 to 255 d: 0 to 254 [10.5.5.100]	Enter the IP address for the Sensor Controller.
Subnet mask	0.0.0.0 to 255.255.255.255 [255.255.255.0]	Enter the subnet mask address.
Default gateway	a.b.c.d a: 1 to 223 b: 0 to 255 c: 0 to 255 d: 0 to 255 [10.5.5.100]	Enter the default gateway address.
DNS server	a.b.c.d a: 1 to 223 b: 0 to 255 c: 0 to 255 d: 0 to 255 [10.5.5.100]	Enter the DNS server address.
Preferred WINS server	a.b.c.d a: 1 to 223 b: 0 to 255 c: 0 to 255 d: 0 to 255 [0.0.0.0]	Enter the WINS server address.
Alternate WINS server	a.b.c.d a: 1 to 223 b: 0 to 255 c: 0 to 255 d: 0 to 255 [0.0.0.0]	Enter the WINS server address.

Setting item	Setting value [Factory default]	Description
Address Settings 2 Address Settings is only for the following series: FH-2000 / FH-5000 / FH-L / FHV series		Set the IP address for the lower Ethernet port on the Sensor Controller.

Setting item	Setting value [Factory default]	Description
	<ul style="list-style-type: none"> Obtain an IP address automatically. [Use the following IP address] 	Same as "Address Settings".
IP Address	a.b.c.d a: 1 to 223 b: 0 to 255 c: 0 to 255 d: 0 to 254 [10.5.6.100]	
Subnet mask	0.0.0.0 to 255.255.255.255 [255.255.255.0]	
Default gateway	a.b.c.d a: 1 to 223 b: 0 to 255 c: 0 to 255 d: 0 to 255 [10.5.6.100]	
DNS server	a.b.c.d a: 1 to 223 b: 0 to 255 c: 0 to 255 d: 0 to 255 [10.5.6.100]	
Preferred WINS server	a.b.c.d a: 1 to 223 b: 0 to 255 c: 0 to 255 d: 0 to 255 [0.0.0.0]	
Alternate WINS server	a.b.c.d a: 1 to 223 b: 0 to 255 c: 0 to 255 d: 0 to 255 [0.0.0.0]	Enter the WINS server address.

Setting item	Setting value [Factory default]	Description
--------------	------------------------------------	-------------

Input and Output settings

Output IP Address/TCP Server*1	a.b.c.d a: 1 to 223 b: 0 to 255 c: 0 to 255 d: 0 to 254 [0.0.0.0] / [10.5.5.101]*1	Enter the IP address for the output destination.
--------------------------------	--	--

Setting item	Setting value [Factory default]	Description
Input/Output port No.	0 to 65,535 ^{*2} [9,600] / [9,876] ^{*3}	Set the port number to use for the data input and output with the Sensor Controller.

- *1. When the TCP is used for the connection, *TCP Server* is displayed. Factory default settings are [10.5.5.101].
- *2. When the UDP is used for the connection, do not set the port numbers from "9,700" to "9,700 + line number" .
- *3. When the TCP is used for the connection, Factory default settings are [9,876].



Precautions for Correct Use

- If the operation mode is set to **Multi-line Random-trigger Mode**, set a different I/O port number for each line.
- Change the IP address and subnet mask for **Address setting** and **Address setting 2** as required so that each designate a different network address. If the same network address were specified, communications may not be performed correctly.
- Be sure to change the output IP address from its factory default value in accordance with your network environment.

3 Click **PLC Link**.

The PLC Link view is displayed.

4 Set the following items.

Some setting items vary depending on the selected communication module.

Communicating with an OMRON PLC

(When **PLC Link (Sysmac CS/CJ/CP/One)** is selected for the communication module.)

Setting item	Setting value [Factory default]	Description
Command Area		

Setting item	Setting value [Factory default]	Description
Areas	<ul style="list-style-type: none"> • [Channel Area (CIO)] • Work Area (WR) • Holding Bit Area (HR) • Auxiliary Bit Area (AR) • Data Memory Areas (DM) • Extended Data Memory Areas (EM) (EM0 to EMC) 	<p>Set the Command Area.</p> <p>The range of the available area varies depending on the PLC types to be connected. Check the specifications of the PLC to be connected.</p>
Address	0 to 99,999 [0]	Set the first channel address of the Command Area.
Response Area		
Areas	<ul style="list-style-type: none"> • [Channel Area (CIO)] • Work Area (WR) • Holding Bit Area (HR) • Auxiliary Bit Area (AR) • Data Memory Areas (DM) • Extended Data Memory Areas (EM) (EM0 to EMC) 	<p>Set the Response Area.</p> <p>The range of the available area varies depending on the PLC types to be connected. Check the specifications of the PLC to be connected.</p>
Address	0 to 99,999 [100]	Set the first channel address of the Response Area.
Data Output Area		
Areas	<ul style="list-style-type: none"> • [Channel Area (CIO)] • Work Area (WR) • Holding Bit Area (HR) • Auxiliary Bit Area (AR) • Data Memory Areas (DM) • Extended Data Memory Areas (EM) (EM0 to EMC) 	<p>Set the Data Output Area.</p> <p>The range of the available area varies depending on the PLC types to be connected. Check the specifications of the PLC to be connected.</p>
Address	0 to 99,999 [200]	Set the first channel address of the Data Output Area.

Setting item	Setting value [Factory default]	Description
Output Control	<ul style="list-style-type: none"> None [Handshaking] 	<p>Set whether to provide an interlock with the PLC when the data is performed.</p> <p>None: Data is output regardless of the status for signals from the PLC. The GATE is always OFF.</p> <p>Handshaking: Data is output after the DSA signal from the PLC was checked.</p>
Asynchronous Output *2	<ul style="list-style-type: none"> Selected [Not selected] 	<p>Selected: Measurement processing and data output processing are performed in parallel. The data output processing does not affect the processing time of the measurement flow.</p> <p>[Not selected] Measurement processing and data output processing are synchronized so that all data output processing is completed at the measurement end. This increases the overall processing time for the measurement flow. For details, refer to <i>Asynchronous Output</i> on page 2-154.</p>
Retry interval [ms]	0 to 999,999 [10,000]	<p>Set the time until when a timeout error will occur because the PLC Link communications are not established with incorrect communication settings or communication cables broken.*1</p> <p>After a timeout error occurred, communications with the destination device will be attempted with the interval time set in the <i>Retry interval</i>.</p> <p>For details, refer to <i>Data Output Control with Handshaking</i> on page 1-24.</p>
Retry Interval 2 [ms]	0 to 999,999 [10,000]	<p>When the PLC Link communications fail due to a temporary response delay affected by heavy network loads and the PLC internal status, the command will be re-transmitted to the destination device after the time set in the <i>Retry Interval 2</i> passed.</p> <p>Set the shorter time in the <i>Retry Interval 2</i> than that in the <i>Retry Interval</i>.</p> <p>Normally use the default values.</p>

Setting item	Setting value [Factory default]	Description
Polling Cycle [ms]	-1 to 999,999 [0]	-1: When this value is set, polling will not be performed in normal operation. This setting eliminates influence to measurement processing time due to communications (polling) in normal operation. Although commands will not be performed, data output and flow control can be performed. 0 to 999,999: Set the interval at which the Sensor Controller checks that the Command Execute (EXE) signal from an external device such as PLC, switches from OFF to ON.

*1. In the communications using *Handshaking*, a timeout error will also occur if any of the following operations were not performed within the time set this *Retry interval* as well..

- If the DSA signal were not turned ON even after a certain time passed from when measurement has been completed.
- If the DSA signal did not switch from ON to OFF even after a certain time passed from when the GATE signal has switched from OFF to ON.
- If the DSA signal did not switch from OFF to ON even after a certain time passed from when the GATE signal has switched from ON to OFF.

*2:



Precautions for Correct Use

Always set the output control to *Handshaking* for asynchronous output. If you set the output control to *None*, operation will be fixed at the following values: Output time: 100 [ms], Output period: 200 [ms].

If you need a shorter output time and output period when the output control is set to *None*, uncheck the asynchronous output option.

Communicate with a Mitsubishi Electric PLC

(When **PLC Link (MELSEC/QnU/Q/QnAS)** is selected for the communication module.)

Setting item	Setting value [Factory default]	Description
Frame type	<ul style="list-style-type: none"> [3E frame] 4E frame 	Match the settings with those on the destination PLC.
Command Area		
Areas	<ul style="list-style-type: none"> [Data register] File register Link register 	Set the Command Area. The range of the available area varies depending on the PLC types to be connected. Check the specifications of the PLC to be connected.
Address	0 to 99,999 [0]	Set the first channel address of the Command Area.
Response Areas		
Areas	<ul style="list-style-type: none"> [Data register] File register Link register 	Set the Response Area. The range of the available area varies depending on the PLC types to be connected. Check the specifications of the PLC to be connected.
Address	0 to 99,999 [100]	Set the first channel address of the Response Area.
Data Output Area		
Areas	<ul style="list-style-type: none"> [Data register] File register Link register 	Set the Data Output Area. The range of the available area varies depending on the PLC types to be connected. Check the specifications of the PLC to be connected.
Address	0 to 99,999 [200]	Set the first channel address of the Data Output Area.

Setting item	Setting value [Factory default]	Description
Output Control	<ul style="list-style-type: none"> None [Handshaking] 	<p>Set whether to provide an interlock with the PLC when the data is performed.</p> <p>None: Data is output regardless of the status for signals from the PLC. The GATE is always OFF.</p> <p>Handshaking: Data is output after the DSA signal from the PLC was checked.</p>
Asynchronous Output *2	<ul style="list-style-type: none"> Selected [Not selected] 	<p>Selected: Measurement processing and data output processing are performed in parallel. The data output processing does not affect the processing time of the measurement flow.</p> <p>[Not selected] Measurement processing and data output processing are synchronized so that all data output processing is completed at the measurement end. This increases the overall processing time for the measurement flow.</p> <p>For details, refer to <i>Asynchronous Output</i> on page 2-154.</p>
Retry interval [ms]	0 to 999,999 [10,000]	<p>Set the time until when a timeout error will occur because the PLC Link communications are not established with incorrect communication settings or communication cables broken.*1</p> <p>After a timeout error occurred, communications with the destination device will be attempted with the interval time set in the <i>Retry interval</i>.</p> <p>For details, refer to <i>Data Output Control with Handshaking</i> on page 1-24.</p>
Retry Interval 2 [ms]	0 to 999,999 [10,000]	<p>When the PLC Link communications fail due to a temporary response delay affected by heavy network loads and the PLC internal status, the command will be re-transmitted to the destination device after the time set in the <i>Retry Interval 2</i> passed.</p> <p>Set the shorter time in the <i>Retry Interval 2</i> than that in the <i>Retry Interval</i>.</p> <p>Normally use the default values.</p>

Setting item	Setting value [Factory default]	Description
Polling Cycle [ms]	-1 to 999,999 [0]	-1: When this value is set, polling will not be performed in normal operation. This setting eliminates influence to measurement processing time due to communications (polling) in normal operation. Although commands will not be performed, data output and flow control can be performed. 0 to 999,999: Set the interval at which the Sensor Controller checks that the Command Execute (EXE) signal from an external device such as PLC, switches from OFF to ON.

- *1. In the communications using *Handshaking*, a timeout error will also occur if any of the following operations were not performed within the time set this *Retry interval* as well..
- If the DSA signal were not turned ON even after a certain time passed from when measurement has been completed.
 - If the DSA signal did not switch from ON to OFF even after a certain time passed from when the GATE signal has switched from OFF to ON.
 - If the DSA signal did not switch from OFF to ON even after a certain time passed from when the GATE signal has switched from ON to OFF.

*2:



Precautions for Correct Use

Always set the output control to *Handshaking* for asynchronous output. If you set the output control to *None*, operation will be fixed at the following values: Output time: 100 [ms], Output period: 200 [ms].

If you need a shorter output time and output period when the output control is set to *None*, uncheck the asynchronous output option.

Communicating with a Yaskawa Electric PLC

(When **PLC Link (JEPMC MP)** is selected for the Communication module.)

Setting item	Setting value [Factory default]	Description
Command Area		
Areas	Data register	Set the Command Area. The range of the available area varies depending on the PLC types to be connected. Check the specifications of the PLC to be connected.
Address	0 to 99,999 [0]	Set the first channel address of the Command Area.
Response Areas		
Areas	Data register	Set the Response Area. The range of the available area varies depending on the PLC types to be connected. Check the specifications of the PLC to be connected.
Address	0 to 99,999 [100]	Set the first channel address of the Response Area.
Data Output Area		
Areas	Data register	Set the Data Output Area. The range of the available area varies depending on the PLC types to be connected. Check the specifications of the PLC to be connected.
Address	0 to 99,999 [200]	Set the first channel address of the Data Output Area.

Setting item	Setting value [Factory default]	Description
Output Control	<ul style="list-style-type: none"> None [Handshaking] 	<p>Set whether to provide an interlock with the PLC when the data is performed.</p> <p>None: Data is output regardless of the status for signals from the PLC. The GATE is always OFF.</p> <p>Handshaking: Data is output after the DSA signal from the PLC was checked.</p>
Asynchronous Output *2	<ul style="list-style-type: none"> Selected [Not selected] 	<p>Selected: Measurement processing and data output processing are performed in parallel. The data output processing does not affect the processing time of the measurement flow.</p> <p>[Not selected] Measurement processing and data output processing are synchronized so that all data output processing is completed at the measurement end. This increases the overall processing time for the measurement flow. For details, refer to <i>Asynchronous Output</i> on page 2-154.</p>
Retry interval [ms]	0 to 999,999 [10,000]	<p>Set the time until when a timeout error will occur because the PLC Link communications are not established with incorrect communication settings or communication cables broken.*1</p> <p>After a timeout error occurred, communications with the destination device will be attempted with the interval time set in the <i>Retry interval</i>.</p> <p>For details, refer to <i>Data Output Control with Handshaking</i> on page 1-24.</p>
Retry Interval 2 [ms]	0 to 999,999 [10,000]	<p>When the PLC Link communications fail due to a temporary response delay affected by heavy network loads and the PLC internal status, the command will be re-transmitted to the destination device after the time set in the <i>Retry Interval 2</i> passed.</p> <p>Set the shorter time in the <i>Retry Interval 2</i> than that in the <i>Retry Interval</i>.</p> <p>Normally use the default values.</p>

Setting item	Setting value [Factory default]	Description
Polling Cycle [ms]	-1 to 999,999 [0]	-1: When this value is set, polling will not be performed in normal operation. This setting eliminates influence to measurement processing time due to communications (polling) in normal operation. Although commands will not be performed, data output and flow control can be performed. 0 to 999,999: Set the interval at which the Sensor Controller checks that the Command Execute (EXE) signal from an external device such as PLC, switches from OFF to ON.

- *1. In the communications using *Handshaking*, a timeout error will also occur if any of the following operations were not performed within the time set this *Retry interval* as well..
- If the DSA signal were not turned ON even after a certain time passed from when measurement has been completed.
 - If the DSA signal did not switch from ON to OFF even after a certain time passed from when the GATE signal has switched from OFF to ON.
 - If the DSA signal did not switch from OFF to ON even after a certain time passed from when the GATE signal has switched from ON to OFF.

*2:



Precautions for Correct Use

Always set the output control to *Handshaking* for asynchronous output. If you set the output control to *None*, operation will be fixed at the following values: Output time: 100 [ms], Output period: 200 [ms].

If you need a shorter output time and output period when the output control is set to *None*, uncheck the asynchronous output option.

- 5 Click **Apply** to apply the settings.
Click **Close** to close the System Settings dialog box.

Connecting via RS-232C

- 1 On the Main window, click **Tool - System Settings** to open the system settings. Select **System Settings** and then select **Communication** → **RS-232C/422 (PLC Link (SYSMAC CS/CJ/CP/One))** or **RS-232C/422 (PLC Link (MELSEC QnU/Q/QnAS))**. The serial interface window is displayed.
- 2 In the communication setting area, set each items.

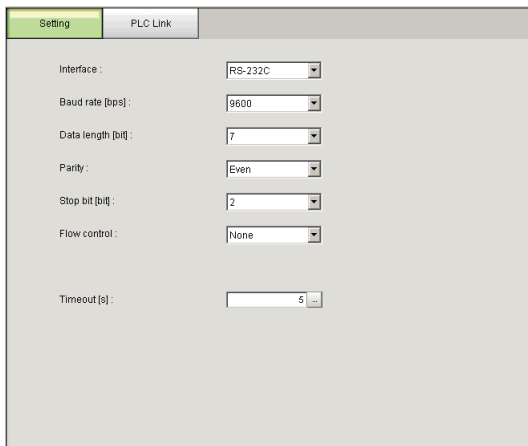

Setting item	Set value [Factory default]	Description
Interface	<ul style="list-style-type: none"> • [RS-232C • RS-422*3 	Align the communication specifications with the PLC. When you connect an OMRON's PLC, set it to <i>Host Link</i> communications.
Baud rate [bps]*1	<ul style="list-style-type: none"> • 2,400 • 4,800 • [9,600] • 19,200 • 38,400 • 57,600 • 115,200 	Align the communication specifications with the PLC.
Data length [bit]*2	<ul style="list-style-type: none"> • [7] • 8 	Align the communication specifications with the PLC.
parity	<ul style="list-style-type: none"> • None • Odd • [Even] 	
Stop bit [bit]	<ul style="list-style-type: none"> • 1 • [2] 	
Flow control	<ul style="list-style-type: none"> • [None] • Xon/Xoff 	None: The software does not perform the flow control. If the time in which there is no response from external devices reaches the timeout setting time, a timeout error occurs and an error message is displayed in the window. Moreover, the parallel interface ERROR signal turns ON. Xon/Xoff The software performs the flow control. Data is transmitted according to the Xon/Xoff codes from external devices.
Timeout [s]	<ul style="list-style-type: none"> • 1 to 120 • [5] 	Set the time in which a timeout error will occur.

*1. If a baud rate of 38,400 bps or higher were selected, communications may not be established well depending on the cable length because communication speeds or 20 Kbps are not defined in RS-232C standards. In this case, set it to 19,200 bps or lower baud rate.
 *2. With the RS-232C MELSEC Q series, set the data length to 8.
 *3. RS-422 is unavailable in the MELSEC Q series and the FH/FHV series.

3 Click **PLC Link**.
 The PLC Link view is displayed.

4 Set the following items.

Some setting items vary depending on the selected communication module.

Communicating with an OMRON PLC

(When **PLC Link (Sysmac CS/CJ/CP/One)** is selected for the communication module.)

Setting item	Setting value [Factory default]	Description
Command Area		
Areas	<ul style="list-style-type: none"> • [Channel Area (CIO)] • Work Area (WR) • Holding Bit Area (HR) • Auxiliary Bit Area (AR) • Data Memory Areas (DM) • Extended Data Memory Areas (EM) (EM0 to EMC) 	Set the Command Area.
Address	0 to 99,999 [0]	Set the first channel address of the Command Area.
Response Area		
Areas	<ul style="list-style-type: none"> • [Channel Area (CIO)] • Work Area (WR) • Holding Bit Area (HR) • Auxiliary Bit Area (AR) • Data Memory Areas (DM) • Extended Data Memory Areas (EM) (EM0 to EMC) 	Set the Response Area.
Address	0 to 99,999 [100]	Set the first channel address of the Response Area.
Data Output Area		

Setting item	Setting value [Factory default]	Description
Areas	<ul style="list-style-type: none"> • [Channel Area (CIO)] • Work Area (WR) • Holding Bit Area (HR) • Auxiliary Bit Area (AR) • Data Memory Areas (DM) • Extended Data Memory Areas (EM) (EM0 to EMC) 	Set the Data Output Area.
Address	0 to 99,999 [200]	Set the first channel address of the Data Output Area.

Setting item	Setting value [Factory default]	Description
Output Control	<ul style="list-style-type: none"> • None • [Handshaking] 	<p>Set whether to provide an interlock with the PLC when the data is performed.</p> <p>None: Data is output regardless of the status for signals from the PLC. The GATE is always OFF.</p> <p>Handshaking: Data is output after the DSA signal from the PLC was checked.</p>
Asynchronous Output *2	<ul style="list-style-type: none"> • Selected • [Not selected] 	<p>Selected: Measurement processing and data output processing are performed in parallel. The data output processing does not affect the processing time of the measurement flow.</p> <p>[Not selected] Measurement processing and data output processing are synchronized so that all data output processing is completed at the measurement end. This increases the overall processing time for the measurement flow.</p> <p>For details, refer to <i>Asynchronous Output</i> on page 2-154.</p>
Retry interval [ms]	0 to 999,999 [10,000]	<p>Set the time until when a timeout error will occur because the PLC Link communications are not established with incorrect communication settings or communication cables broken.*1</p> <p>After a timeout error occurred, communications with the destination device will be attempted with the interval time set in the <i>Retry interval</i>.</p> <p>For details, refer to <i>Data Output Control with Handshaking</i> on page 1-24.</p>

Setting item	Setting value [Factory default]	Description
Retry Interval 2 [ms]	0 to 999,999 [10,000]	When the PLC Link communications fail due to a temporary response delay affected by heavy network loads and the PLC internal status, the command will be re-transmitted to the destination device after the time set in the <i>Retry Interval 2</i> passed. Set the shorter time in the <i>Retry Interval 2</i> than that in the <i>Retry Interval</i> . Normally use the default values.
Polling Cycle [ms]	-1 to 999,999 [0]	-1: When this value is set, polling will not be performed in normal operation. This setting eliminates influence to measurement processing time due to communications (polling) in normal operation. Although commands will not be performed, data output and flow control can be performed. 0 to 999,999: Set the interval at which the Sensor Controller checks that the Command Execute (EXE) signal from an external device such as PLC, switches from OFF to ON.

- *1. In the communications using *Handshaking*, a timeout error will also occur if any of the following operations were not performed within the time set this *Retry interval* as well..
- If the DSA signal were not turned ON even after a certain time passed from when measurement has been completed.
 - If the DSA signal did not switch from ON to OFF even after a certain time passed from when the GATE signal has switched from OFF to ON.
 - If the DSA signal did not switch from OFF to ON even after a certain time passed from when the GATE signal has switched from ON to OFF.

*2:



Precautions for Correct Use

Always set the output control to *Handshaking* for asynchronous output. If you set the output control to *None*, operation will be fixed at the following values: Output time: 100 [ms], Output period: 200 [ms].

If you need a shorter output time and output period when the output control is set to *None*, uncheck the asynchronous output option.

Communicate with a Mitsubishi Electric PLC

(When PLC Link (MELSEC/QnU/Q/QnAS) is selected for the communication module.)

Setting item	Setting value [Factory default]	Description
Frame type	<ul style="list-style-type: none"> • [3E frame] • 4E frame 	Match the settings with those on the destination PLC.
Command Area		

Setting item	Setting value [Factory default]	Description
Areas	<ul style="list-style-type: none"> [Data register] File register Link register 	Set the Command Area. The range of the available area varies depending on the PLC types to be connected. Check the specifications of the PLC to be connected.
Address	0 to 99,999 [0]	Set the first channel address of the Command Area.
Response Areas		
Areas	<ul style="list-style-type: none"> [Data register] File register Link register 	Set the Response Area. The range of the available area varies depending on the PLC types to be connected. Check the specifications of the PLC to be connected.
Address	0 to 99,999 [100]	Set the first channel address of the Response Area.
Data Output Area		
Areas	<ul style="list-style-type: none"> [Data register] File register Link register 	Set the Data Output Area. The range of the available area varies depending on the PLC types to be connected. Check the specifications of the PLC to be connected.
Address	0 to 99,999 [200]	Set the first channel address of the Data Output Area.

Setting item	Setting value [Factory default]	Description
Output Control	<ul style="list-style-type: none"> None [Handshaking] 	Set whether to provide an interlock with the PLC when the data is performed. None: Data is output regardless of the status for signals from the PLC. The GATE is always OFF. Handshaking: Data is output after the DSA signal from the PLC was checked.
Asynchronous Output *2	<ul style="list-style-type: none"> Selected [Not selected] 	Selected: Measurement processing and data output processing are performed in parallel. The data output processing does not affect the processing time of the measurement flow. [Not selected] Measurement processing and data output processing are synchronized so that all data output processing is completed at the measurement end. This increases the overall processing time for the measurement flow. For details, refer to <i>Asynchronous Output</i> on page 2-154.

Setting item	Setting value [Factory default]	Description
Retry interval [ms]	0 to 999,999 [10,000]	Set the time until when a timeout error will occur because the PLC Link communications are not established with incorrect communication settings or communication cables broken. ^{*1} After a timeout error occurred, communications with the destination device will be attempted with the interval time set in the <i>Retry interval</i> . For details, refer to <i>Data Output Control with Handshaking</i> on page 1-24.
Retry Interval 2 [ms]	0 to 999,999 [10,000]	When the PLC Link communications fail due to a temporary response delay affected by heavy network loads and the PLC internal status, the command will be re-transmitted to the destination device after the time set in the <i>Retry Interval 2</i> passed. Set the shorter time in the <i>Retry Interval 2</i> than that in the <i>Retry Interval</i> . Normally use the default values.
Polling Cycle [ms]	-1 to 999,999 [0]	-1: When this value is set, polling will not be performed in normal operation. This setting eliminates influence to measurement processing time due to communications (polling) in normal operation. Although commands will not be performed, data output and flow control can be performed. 0 to 999,999: Set the interval at which the Sensor Controller checks that the Command Execute (EXE) signal from an external device such as PLC, switches from OFF to ON.

*1. In the communications using *Handshaking*, a timeout error will also occur if any of the following operations were not performed within the time set this *Retry interval* as well..

- If the DSA signal were not turned ON even after a certain time passed from when measurement has been completed.
- If the DSA signal did not switch from ON to OFF even after a certain time passed from when the GATE signal has switched from OFF to ON.
- If the DSA signal did not switch from OFF to ON even after a certain time passed from when the GATE signal has switched from ON to OFF.

*2:



Precautions for Correct Use

Always set the output control to *Handshaking* for asynchronous output. If you set the output control to *None*, operation will be fixed at the following values: Output time: 100 [ms], Output period: 200 [ms].

If you need a shorter output time and output period when the output control is set to *None*, uncheck the asynchronous output option.

- 5 Click **Apply** to apply the settings.
Click **Close** to close the System Settings dialog box.

Asynchronous Output

In *Asynchronous output*, measurement flow and data output processing are performed in parallel. The data output processing does not affect the measurement flow processing.

Clear the option for *Asynchronous output* when you want to perform output in the same way as for FZ4 series and former models. This enables synchronous output, which means that the subsequent measurement flow is continuously performed only after the data output processing for the current measurement flow was completed. Although all data output processing finishes at measurement end, this increases the overall processing time for the measurement flow.

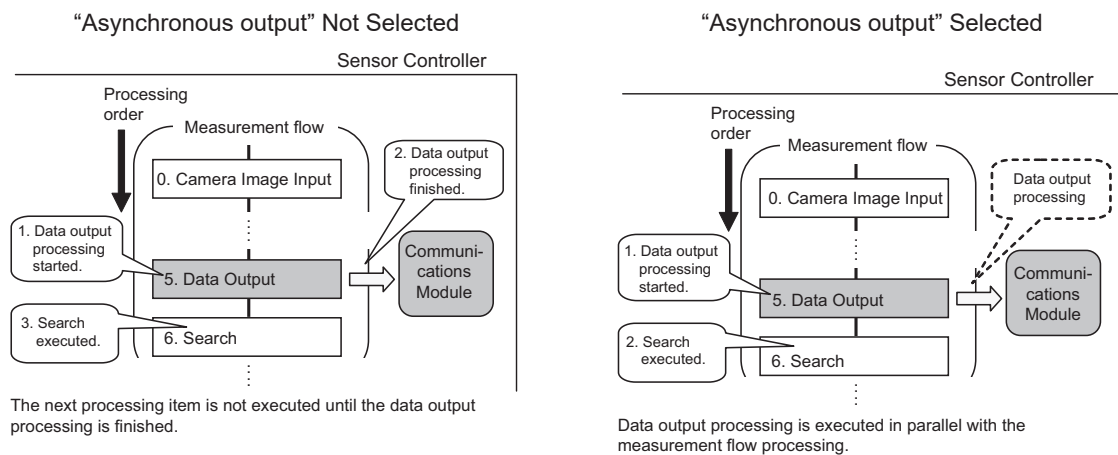

Precautions for Correct Use

Always set the output control to *Handshaking* for asynchronous output. If you set the output control to *None*, operation will be fixed at the following values: Output time: 100 [ms], Output period: 200 [ms].

If you need a shorter output time and output period when the output control is set to *None*, uncheck the asynchronous output option.

2-2-5 Output Data Settings (Processing Item Registration)

Here, set the output items and output format to be used in PLC Link.

This processing item is not available in the FHV series. When you set output data in the FHV series, refer to *2-2-6 Setting Output Data (Numerical Values and Character Strings)* on page 2-159.



Additional Information

When outputting characters read by a processing item such as Barcode, these settings are set in the processing item used to read the characters (Character Inspection, Barcode, or 2DCode). Refer to the descriptions for each processing item for details on the character output settings and output format. (Reference Manual (Cat. No. Z341).)

- *Character Inspection*
Refer to *Character Inspection* in the *Vision System FH/FHV Series Processing Items*
- *Barcode*
Refer to *Barcode* in the *Vision System FH/FHV Series Processing Items*
- *2DCode*
Refer to *2DCode* in the *Vision System FH/FHV Series Processing Items*
- *OCR*
Refer to *OCR* in the *Vision System FH/FHV Series Processing Items*

Registering Processing Items

Register the processing items for data output in the measurement flow.

- 1 Click **Edit flow** in the Toolbox Pane.
- 2 Select the **Data Output** processing item in the processing item tree.

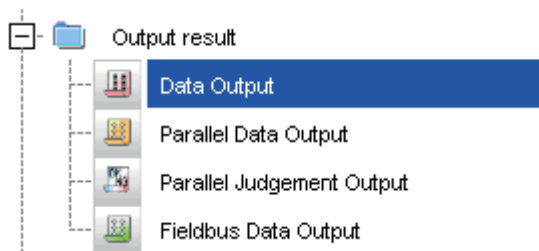

- 3 Click **Append**.
The **Data Output** processing item is added at the bottom of the unit list (flow).

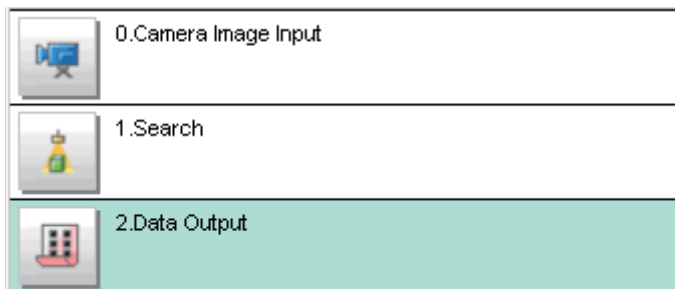

- 4 Click *Data Output*  icon and set the data output items and data format.
For details of the settings, refer to the following.
Registering the Items to Output on page 2-156



Additional Information

- The number of items that can be output in a single data output processing item is 8 to 256. If you need to output more data items, use more than one Output Unit. If multiple Output Units are registered in the same measurement flow, the data is output to the same destination. If you do not control the output, the output data that was output first will be overwritten by the output data that is output after it. Use one of the following methods to read each set of output data.

Offset	You can offset the location where the output data is written in the Data Output Area for each Output Unit. Set the Offset for the Data Output processing item. For details, refer to <i>Output Format (Data Output)</i> on page 2-330.
Controlling data output with handshaking	If handshaking is used to control data output, the timing of outputting the data is controlled by I/O signals. Each time that data is output, read the output data and move it to a different part of I/O memory in the PLC. For details on handshaking, refer to <i>Data Output Control with Handshaking</i> on page 1-24.

- Data is output in the order that data output is registered in the measurement flow, i.e., the timing is different for each data output processing item. (Data output is executed in the order that it is executed in the measurement flow.)
For details, refer to *Outputting the Measurement Data* on page 1-18.

Registering the Items to Output

Set the output data with expressions.

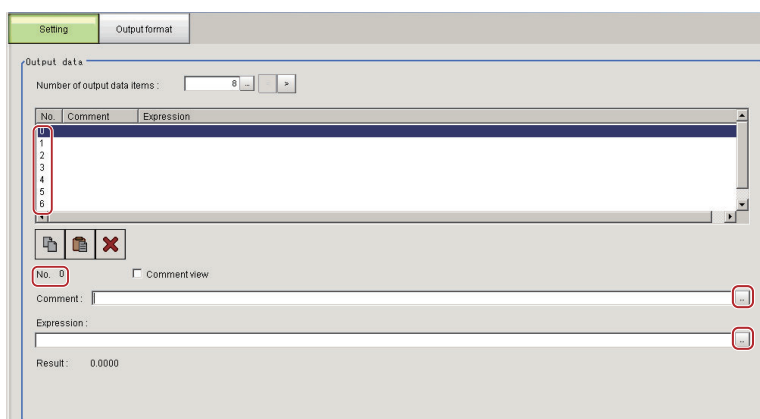

- Click Data Output  icon in the measurement unit list (flow).
- In the Item tab area, click **Setting**.



- In the list, click the output data number to set the expression. The selected output data number is displayed under the list.
- Click  next to the expression text box and set the expression.



Specify the processing items, measurement results, and measurement data in the expression. Arithmetic or function calculations can be applied to the measurement data to output. For details of the calculation settings, refer to *Calculation* in the *Vision System FH/FHV Series Processing Items Reference Manual (Cat. No. Z341)*.

- 5 Click  for the **Comment** text box and enter the description for the expression. The entered comment will be displayed in the detailed results area on the Main window. For example, *Test* was entered as the comment for the expression 0, *Test* will be displayed instead of *Expression 0* in the detailed results areas on the Main window.
- 6 When you want to output more than nine items, click  under the **Number of output data items** and change the number of output items for the Output Unit. By default you can output up to eight items, but you can change this to output a maximum of 256 output data items (Max. 1,024 bytes).
- 7 Repeat step 3 to 5 to set expressions for all of the required output data numbers.



Additional Information

If you delete one of the expressions that is set for output data 0 through 255, the output numbers for all expressions after the deleted expression will stay the same. However, the actual data output will be output as though the list has been shifted forward for the number of expressions that have been deleted.

To prevent data from being written to the wrong locations, use copy and paste to manually shift the expressions after the deleted number forward.

Example: If the Expression for Output 1 Is Deleted

Output Item Settings

No.	Comment	Expression
0	Reference SX	U1.SX
1	Reference SY	U1.SY
2	Reference an...	U1.ST
3		
4		

Data Output Destination (Data Output Area)

First word	Bit	
	15	to 0
+10	DATA1 (Reference SX)	
+11		
+12	DATA2 (Reference SY)	
+13		
+14	DATA3 (Reference angle ST)	
+15		



Output 1 is deleted.

Output Item Settings

No.	Comment	Expression
0	Reference SX	U1.SX
1		
2	Reference an...	U1.ST
3		
4		

Data Output Destination (Data Output Area)

First word	Bit	
	15	to 0
+10	DATA1 (Reference SX)	
+11		
+12	DATA3 (Reference angle ST)	
+13		
+14		
+15		

The output numbers assigned to the expressions remain the same, but the data output location is shifted forward for data 3.

Output Format (Data Output)

- 1 Click Data Output  icon in the measurement unit list (flow).
- 2 In the item tab area, click **Output format**.
- 3 In the Output Setting Area, select the communication method.

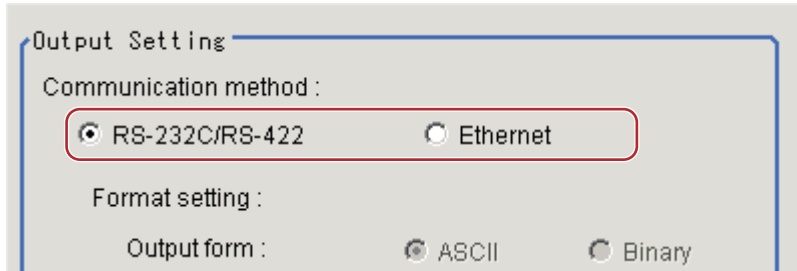

Setting item	Setting value [Factory default]	Description
Communication method	[RS-232C/RS-422]	Communications are performed via the RS-232C/RS-422 connection. *1
	Ethernet	Communications are performed via the Ethernet connection.

*1. RS-422 is unavailable in the MELSEC Q series and the FH/FHV series.

- 4 Set the output format for the data to be output.

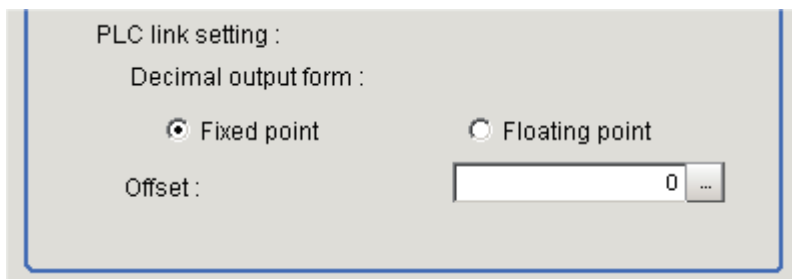

Setting item	Setting value [Factory default]	Description
PLC Link setting		Specifies the output format for the PLC Link.
Decimal output format	<ul style="list-style-type: none"> • [Fixed point] • Floating point 	Use the floating point when you need precision up to four digits decimal point. <ul style="list-style-type: none"> • Fixed point Data is output multiplied by 1,000. ex.: For 123.456, it will be 0001E240 hex. • Floating point Data is output in floating point format. ex.: For -123.4567, it will be C2F6E979 hex.
Offset	0 to 99,999 [0]	Set the number of offset channels in the Data Output Area.

2-2-6 Setting Output Data (Numerical Values and Character Strings)

Registering Processing Items

Register the processing items for data output in the measurement flow.

- 1 In the Main window, click **Edit flow** in the Toolbox Pane.
- 2 Click **Result output (I/O)** in the processing item tree.

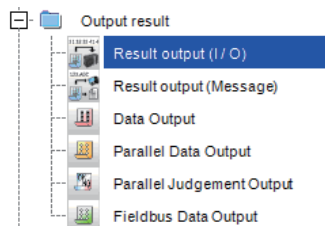

- 3 Click **Append**.
The **Result output (I/O)** processing item is added at the bottom of the unit list (flow).

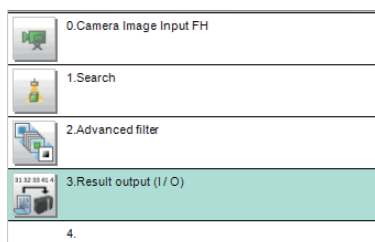

- 4 Click **Result output (I/O)**  icon in the unit list (flow) or **Set** to set the output device and the output data.

出力先を設定する

Here, set a communication method when data is output.

- 1 Click **Result output (I/O)**  icon in the unit list (flow) or **Set** to set the output device and the output data.
The **Result output (I/O)** setting window is displayed.

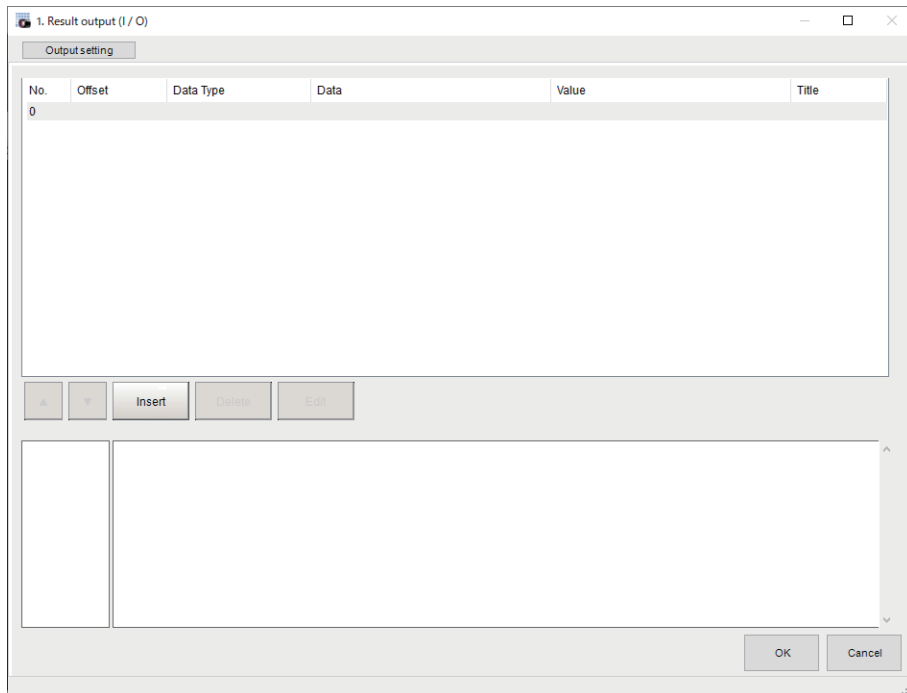

- 2** Click **Output setting**.
The **Output setting** window is displayed.

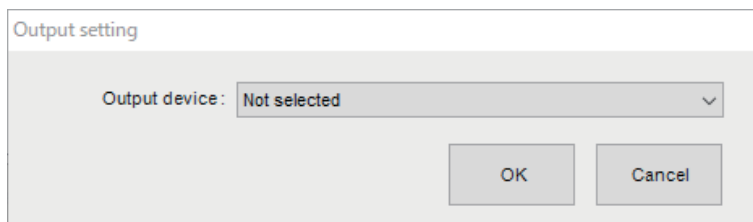

- 3** Click at the right side of the **Output device**. If communicating via RS-232C, select *Serial(Ethernet)*. If communicating via RS-232C, select *Serial(RS-232C/422)*.

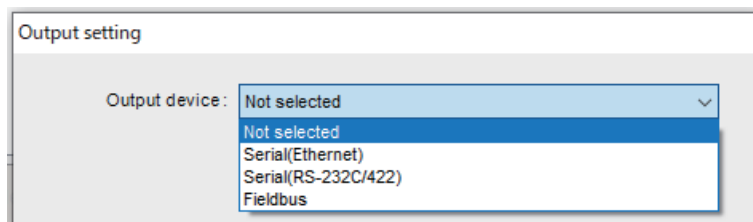

Precautions for Correct Use

- The displayed output device is determined based on the selection of **Communication module** in the **System settings** in the item tab.
- Executing measurements without an output device selected causes a failure (NG: No measurement) in the judgment of the processing unit.

Setting the Output Data

Here, set the data to output such as processing item data or fixed character strings.

- 1 In the item tab area, click **Output data**.
The **Result output (I/O)** setting window is displayed.

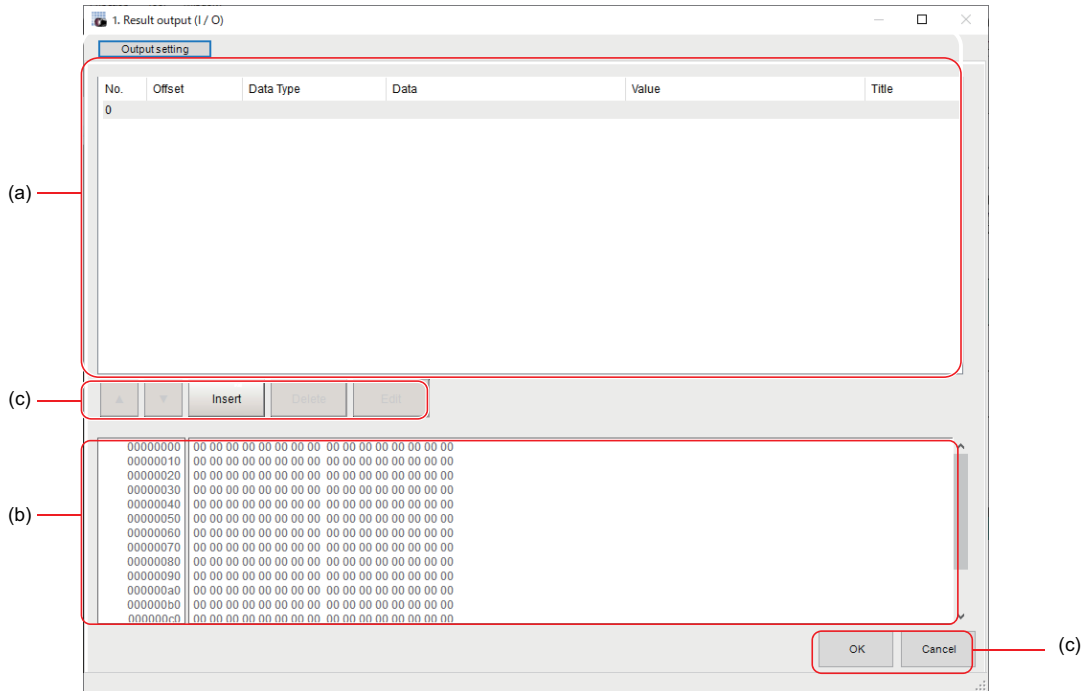

- a) Setting data display area
The No. (output number), Offset (indicating the byte position from the beginning), Data type (integer, double, string), Data, Value, and Title (data description) are displayed in this area. A value is displayed when a variable is assigned to data.
- b) Output data display area
Contents in the output data display area in binary (hex) are displayed in this area.
- c) Button

Button	Description
	Moves the selected data up one position.
	Moves the selected data down one position.
	Adds new data to the selected data position.
	Deletes the selected data. The following data moves up after the deletion.
	Edits the selected data.
	Saves the current settings and returns to the previous view.
	Discards the current settings and returns to the previous view.

- 2 In the list, select the output data number to set the output and then click **Insert**.
The following **Output data editing** dialog box is displayed.

Setting item	Setting value [Factory default]	Description
Data type	<ul style="list-style-type: none"> Integer Double String 	Sets the data type.
Data	—	There are two input methods.*1 <ul style="list-style-type: none"> Enter strings directly Assign variables
Title	—	Enters the description for data.
String settings		Valid when <i>String</i> is selected in the “Data type”.
Size	0 to 4,095 [10]	Sets the number of characters. The number of characters that can be output depends on the data size setting for the tag and tag-set settings in the PLC.
Character code	[0]	Sets the code page according to the language to be used.

*1. Any arithmetic expression cannot be used. If it is used, it will be handled as character strings.

- Character code: Specify the following code page for each language.

Language	Code page	Language	Code page	Language	Code page
Japanese	932	English	1252	Chinese (simplified)	936
German	1252	French	1252	Chinese (traditional)	950
Italian	1252	Spanish	1252	Korean	949
Vietnamese	1258	Polish	1250		

- The default 0 is no language-dependent letters in ANSI code page.
- If non-existing code page is selected, corresponding data is handled as invalid data (NULL).

- 3** Click  at the right side of the **Data type** text box to select the data to output. *Integer*, *Double*, or *String* are selectable.

Data type	Description
Integer	<ul style="list-style-type: none"> Entered data is handled as four-byte data. Allowable entering range is a range of signed INT. When string variables are specified for data, character strings like digits which can be converted into numerical values will be converted and output. When decimal digits are included, they are truncated. Moreover, they are handled as “0” if they are not convertible.

Data type	Description
Double	<ul style="list-style-type: none"> Entered data is handled as eight-byte data. The allowable entering range is a range of eight-byte floating decimal value. When string variables are specified for data, character strings like digits which can be converted into numerical values will be converted and output. Moreover, they are handled as "0" if they are not convertible.
String	<ul style="list-style-type: none"> Entered data is set based on specified <i>Size</i>. Example: Size is four and the entered data is ABCD. ABCD → ABC+NULL The number of allowable entering characters is up to 4,095. If this limit is exceeded, nothing is displayed and output. When NULL is included in the entered character string, the character string following NULL is not output. The following escape sequence codes can be entered. The entered escape sequence codes are handled as fixed character strings. \N: Carriage return, \r: Line feed, \t: Tab, \xXX: ASCII code specified by "XX" (numerical value), \": Double quotation mark, \: Backslash

4 Enter data into *Data* text box.

Data that can be output with one data No. is a range only to be handled as one string.

- 1) When directly entering an output content into the **Data** text box.

A string enclosed with " " (double quotation marks) handled as one string and the rest following it is not output.

Example: "AA"TEST → only "AA" is output.

- 2) In the case where assignment variable is assigned o data:

Directly enter a variable name (Scene variable: SC.~) or specify a variable in *Variable*

assignment window displayed by clicking .

- Only one variable is valid for one data No.
Example: SC.A\$+SC.B\$ → Only SC.A\$ is output.
- When a fixed string, e.g. AA, is entered before a variable, the subsequent variable is also handled as a fixed string.
Example: AA+SC.AA& → "AA+SC.AA&"
- When "String" is selected in the "Data type" but "Integer" or "Double" is set to the variable, then the variable is converted to a string and then output.

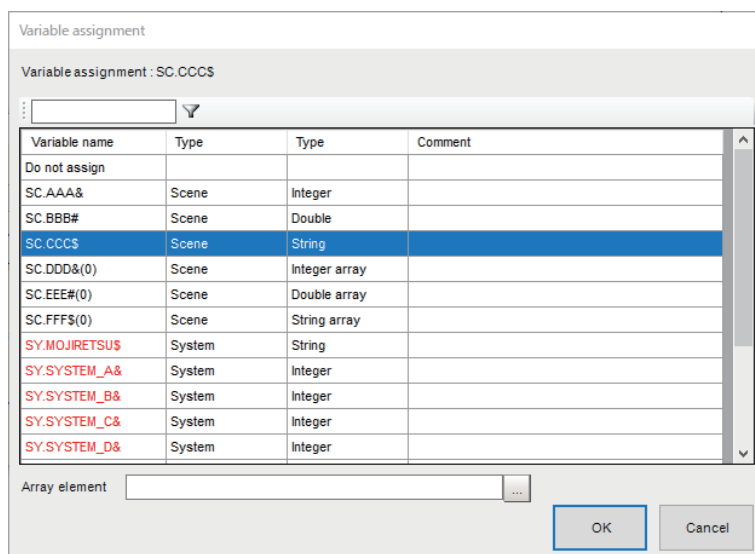

- 5 Enter *Title* that indicates the content of output data.
- 6 When *String* is selected in *Data type*, the following items in *String setting* area also needs to be set.

String setting

Size:

Character code:

When using language dependent characters, please specify the code page according to that language.

Example:

1. Result output (I / O)

Output setting

No.	Offset	Data Type	Data	Value	Title
0	0	Double	SYSTEM_A&	173	
1	8	String	SYMOJIRETSU\$	FH/FJ-XXX	
2	18	Double	111.409385069345		
3	26	String	aiueo		
4	36	Integer	1234		
5					

▲ ▼ Insert Delete Edit

```

00000000 00 00 00 00 00 a0 65 40
00000010 ae 13 8f 5d 33 da 5b 40 61 69 75 65 6f 00
00000020 00 00 00 00 d2 04 00 00 00 00 00 00 00 00 00 00
00000030 00 00 00 00 00 00 00 00 00 00 00 00 00 00 00
00000040 00 00 00 00 00 00 00 00 00 00 00 00 00 00 00
00000050 00 00 00 00 00 00 00 00 00 00 00 00 00 00 00
00000060 00 00 00 00 00 00 00 00 00 00 00 00 00 00 00
00000070 00 00 00 00 00 00 00 00 00 00 00 00 00 00 00
00000080 00 00 00 00 00 00 00 00 00 00 00 00 00 00 00
00000090 00 00 00 00 00 00 00 00 00 00 00 00 00 00 00
000000a0 00 00 00 00 00 00 00 00 00 00 00 00 00 00 00
000000b0 00 00 00 00 00 00 00 00 00 00 00 00 00 00 00
000000c0 00 00 00 00 00 00 00 00 00 00 00 00 00 00 00
    
```

OK Cancel

- 7 Click **OK** in the end of entering data to close the settings.

2-2-7 Testing Communications

Here, check whether or not the PLC Link communication settings are correct.

For the communication settings, refer to *2-2-4 Communication Specifications Settings* on page 2-133.

If communications cannot be established after the setup, use the following procedures to check the setting details and the communication status.

Communicating via Ethernet

● Before Testing Communications

Here, *Serial (Ethernet) - PLC Link (SYSMAC CS/CJ/CP/One) (UDP)* communication module is used as an example to describe the procedures.

When checking the communication settings, stop the program on the external device such as a PLC.

● Checking Communication Settings

Use the following procedures to check whether or not the communication settings are correct.

The screenshot shows three configuration windows. The first, 'Address setting', has 'Use the following IP address' selected with values: IP address: 10.5.5.100, Subnet mask: 255.255.255.0, Default gateway: 10.5.5.100, DNS server: 10.5.5.100, Preferred WINS server: 0.0.0.0, Alternate WINS server: 0.0.0.0. The second, 'Address setting 2', has the same selection with values: IP address: 10.5.6.100, Subnet mask: 255.255.255.0, Default gateway: 10.5.6.100, DNS server: 10.5.6.100, Preferred WINS server: 0.0.0.0, Alternate WINS server: 0.0.0.0. The third, 'Input/Output setting', has 'Output IP address' set to 0.0.0.0 and 'Input/Output port No.' set to 9900.

1. On the Main Window, select [Tool] – [System Settings]. Select [System data], and then select [Communication] – [PLC Link (SYSMAC CS/CJ/CP/One) (UDP)].

2. Set the IP address of the Sensor Controller. The default settings are as follows:
Address setting: 10.5.5.100
Address setting 2: 10.5.6.100

3. Sets IP address for PLC communication to the [Output IP address].

4. Set the port number to use for data I/O with the PLC in [Input port/Output port No.]. Set the same number as the destination PLC.



Precautions for Correct Use

Be sure to match the settings on the PLC for the *Output IP address* and *Input port/Output port No.*. If these settings do not match those on the PLC, PLC Link Error will be displayed on the Sensor Controller.

5. Click the [PLC Link settings] tab.
6. Set the area settings.
Match these settings with those on the destination PLC.
7. Set the output control.
Set whether to provide an interlock with the PLC when performing data output.
8. This completes the Controller settings.

● Checking the Communication Status

Use the ping command to check whether or not the Sensor Controller exists on the Ethernet network.

With it, check that the Sensor Controller IP address has been correctly set and is correctly connected to the Ethernet network.



Additional Information

The ping command uses the ICMP protocol to send a response request to a device connected through an Ethernet network and determines the time required to respond to that request. If you properly receive a response from the destination device, the network connection and network settings are correctly set.

- 1 Connect the Sensor Controller and a computer with an Ethernet cable.
Set the high-order digits of the computer IP address to the same values as the Sensor Controller and the low-order one digit to a different value.

<IP Address Setting Example>

Device	Example
Sensor Controller	10.5.5.100 (default)
Computer	10.5.5.101

- 2 Open the Windows command prompt on the computer and perform the ping command.
At the > prompt, type *ping*, followed by a space and the Sensor Controller IP address, and then press *Enter*.
Example:
C:\>ping 10.5.5.100
- 3 After a few seconds, *Reply from* followed by the IP address of the Sensor Controller (e.g., 10.5.5.100) are displayed, it means that the Sensor Controller is connected to the Ethernet network properly.

Example:

Reply from 10.5.5.100: byte=32

Time<1 ms TTL=128

If anything other than *Reply from* is displayed:

The Sensor Controller is not connected to the Ethernet network for some reason. Check the following.

- Are the high-order three digits of the IP addresses for the computer and the Sensor Controller the same?
- Is the Ethernet cable correctly connected?

- 4** Use the ping command to check the communication status of the external device such as a PLC as well.

After you have confirmed the communication status as described above, transmit a measurement command to the Sensor Controller in practice to check the communication operations as the Vision Sensor.

● Get the Communication log

You can get the Communication log between the PLC and the Sensor Controller. When making inquiries, it will be easier to identify the cause.

When making inquiries, contact one of our branches or regional offices with the log file and the following information.

- Behavior to be investigated.
- Manufacturer and model of your PLC
- FH model, software version, and PLC link communication settings
- Command executed
- Log file when normal and log file when there is a problem

Multiple log files are created.

Please send us the log file that corresponds to the time you executed the command.

The contents of the communication log are command level information.



Additional Information

You can save the command-level Communication log in text format.

- Formats :
<Date and time (up to ms)>;<SEND/RCV>;<Data contents (Hex, spaced every 4 digits)>
- Example :
2019/06/0510:28:31.123;SEND;5000 00FF FF03 000C 0014 0001 0400 0064 0000 A801 00



Precautions for Correct Use

When turning off the power, stop the communication log acquisition. Data can be corrupted or lost.

- 1** On the Main window, click **Tool - System Settings** to open the system settings. Select **System Settings** and then select **Communication** → **Ethernet (PLC Link (SYSMAC CS/CJ/CP/One))**, **Ethernet (PLC Link (MELSEC QnU/Q/QnAS))**, or **Ethernet (PLC Link (JEPMC MP))**.

2 Click **Communication log**.

The Communication log view is displayed.

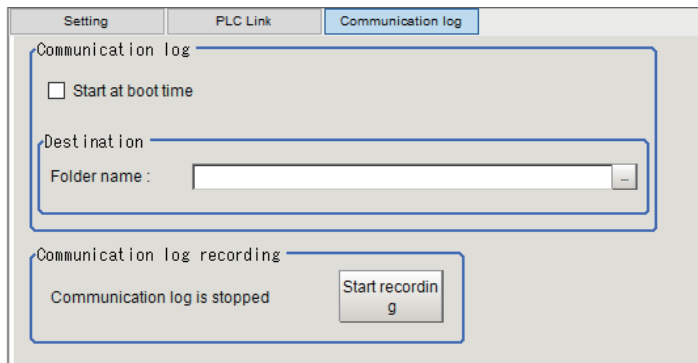
**3** Set the following items.

Setting item	Settin value [Factory default]	Description
Communication log		
Start at boot time	<ul style="list-style-type: none"> Selected [Not selected] 	Select this check box to save, from the next startup, the Communication log recorded since the startup to a file.
Folder name :	-	Select the folder in which to save the Communication log file.
Communication log recording	<ul style="list-style-type: none"> [Communication log is stopped] Communication log is being recordec 	The current acquisition status of the Communication log is displayed. You can click the Start recording / Recording stop button to change the acquisition status. When turning off the power, stop the communication log acquisition.

**Additional Information**

To save the Communication log on each line in Multi-line Random-trigger Mode, set the destination folder for each line to a separate folder.

4 Click **Apply** to apply the settings.

Click **Close** to close the System Settings dialog box.

Communicating via RS-232C

● Before Testing Communications

Here, Serial (RS-232C/422) - PLC Link (SYSMAC CS/CJ/CP/One) (UDP) communication module is used as an example to describe the procedures.

When checking the communication settings, stop the program on the external device such as a PLC.

● **Checking Communication Settings**

Use the following procedures to check whether or not the communication settings are correct.

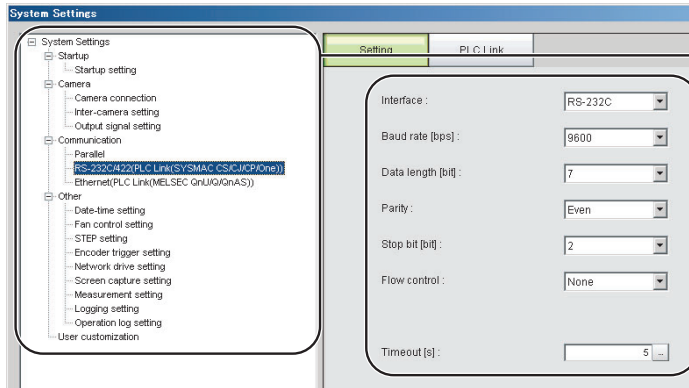

1. On the Main Window, select [Tool] – [System Settings]. Select [System data] from the tree on the left, and then select [Communication] – [RS-232C/422 (PLC Link (SYSMAC CS/CJ/CP/One))].

2. Set these settings based on the communications specifications.

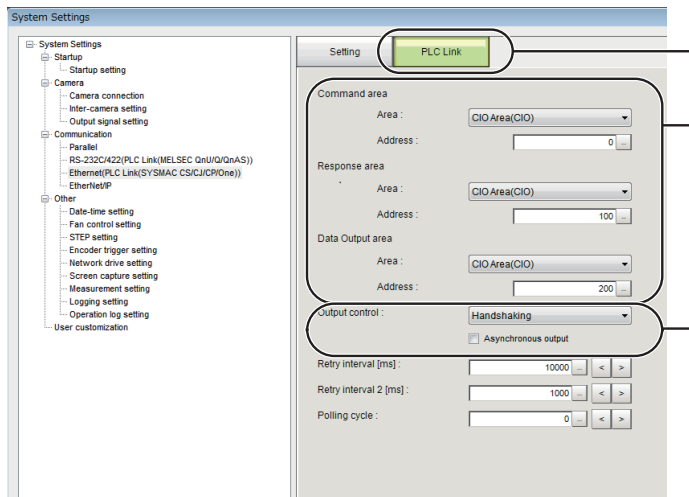

3. Click the [PLC Link settings] tab.

4. Set the area settings. Set these settings based on the connected PLC.

5. Set the output control. Set whether to provide an interlock with the PLC when performing data output.

6. This completes the Sensor Controller settings.

● **Checking the Communication Status**

- 1 Connect the Sensor Controller and PLC with a RS-232C cable.
- 2 When the cable is not connected, check that an error message of *PLC Link Error* will be displayed on the Sensor Controller screen.
- 3 When the cable is connected properly, check that the error message of *PLC Link Error* will disappear.

(At the longest, the message should disappear after the time set as the “Retry interval” passed.)

If the error message of *PLC Link Error* did not disappear, the PLC Link settings are incorrect. Check the following.

- Are the communication parameters for connected devices properly set?
- Is the cable correctly connected?
- Are all cables wired correctly?

After you have confirmed the communication status as described above, transmit a measurement command to the Sensor Controller in practice to check the communication operations as the Vision Sensor.

2-2-8 Memory Allocation

Here, describe allocation for each area for Command Area, Response Area, and Data Output Area.

● Command Area (External Device such as a PLC to Sensor Controller)

First channel in Command Area	Bit																Event name
	15	14	13	12	11	10	9	8	7	6	5	4	3	2	1	0	
+0								X								E	Control input (2CH)
+1								E								X	
+2	CMD-CODE																Command Code (2CH)
+3																	
+4	CMD-PARAM																Command parameters (Variable length)
+5																	
+6																	
+7																	
+8																	
+9																	
+10																	
.																	
.																	
.																	

Signal	Signal name	Function
EXE	Command Request Bit	Performs a command. For details, refer to <i>2-2-11 Command List</i> on page 2-177.
DSA	Data Output Request Bit	Requests the next data output. For details, refer to <i>2-2-5 Output Data Settings (Processing Item Registration)</i> on page 2-155.
XEXE	Flow Command Request Bit	Performs a flow command.
CMD-CODE	Command Code	Stores the command code.
CMD-PARAM	Command parameters	Store the command parameters.

● Response Area (Sensor Controller to External Device such as a PLC)



Additional Information

The order in which data is stored depends on the manufacturer of the connected external device such as an external device such as a PLC.

For details, refer to *A-1-1 Parameter Notation Examples for Command Control* on page A-2.

First channel in Response Area	Bit															Name		
	15	14	13	12	11	10	9	8	7	6	5	4	3	2	1		0	
+0						X W A I T	X B U S Y	X F L G								B U S Y	F L G	Control input (2CH)
+1																G A T E		
+2	CMD-CODE															Command Code (2CH)		
+3																		
+4	RES-CODE															Response Code (2CH)		
+5																		
+6	RES-DATA															Response Data (Variable length)		
+7																		
+8																		
+9																		
+10																		
.																		
.																		
.																		

Signal	Signal name	Function
FLG	Command Completion Bit	Turns ON when command execution is completed.
GATE	Data Output Completion Bit	Turns ON when data output is completed.
BUSY	Command Busy Bit	Performs when command execution is in progress.
XFLG	Flow Command Completion Bit	Turns ON when flow command execution is complete.
XBUSY	Flow Command Busy Bit	Turns ON when flow command execution is in progress.
XWAIT	Flow Command Wait Bit	Turns ON when flow command execution is possible.
CMD-CODE	Command Code	Returns the executed command code.
RES-CODE	Response Code	Stores the response for the executed command.

Signal	Signal name	Function
RES-DATA	Response Data	Stores the response data for the executed command.

● **Data Output Area (Sensor Controller to PLC)**

Data to be output into the Data Output Area is not automatically allocated.

Data to be output is individually allocated to an Output Unit

First channel in Data Output Area	Bit														Name
	15	14	13	12	11	10	9	8	7	6	5	4	3	2	
+0	DATA0														Output data 0
+1															
+2	DATA1														Output data 1
+3															
+4	DATA2														Output data 2
+5															
+6	DATA3														Output data 3
+7															
+8	DATA4														Output data 4
+9															
+10	DATA5														Output data 5
+11															
+12	DATA6														Output data 6
+13															
+14	DATA7*1														Output data 7

Signal	Signal name	Function
DATA 0 to 7	Output data 0 to 7*1	The data set in the output processing item is output. When more than one processing item exists, data is overwritten on this area by performing handshaking.

*1. For PLC Link, the number of data items to be output at once can be extended up to 256.
 Set the number of output data items for each *Output Data* processing item.
 By changing the default value for *the number of output data items* in the *Data Output* processing item from 8 to the maximum of 256, you can output up to DATA255.

Data storage in the PLC I/O memory depends on the connected PLC.

For details, refer to Memory Display Image on PLC I/O in the *Vision System FH/FHV Series User's Manual (Cat. No. Z365)*.

2-2-9 I/O Signals

● Input Signals

Signal	Signal name	Function	ON/OFF timing	
			OFF to ON	ON to OFF
EXE	Command Request Signal	The user (PLC) turns this signal ON when issuing a command to the Sensor Controller.	The user (PLC) turns this signal ON when issuing a command (instruct the execution) to the Sensor Controller based on the command code and command parameters.	The user (PLC) switches this signal from ON to OFF when the Sensor Controller turns the Command Completion (FLG) signal ON.*1
DSA (Used only for handshaking output control)	Data Output Request Signal	During handshaking, the user (PLC) issues this signal to the Sensor Controller to request to output externally the measured results performed in the measurement flow. When this signal is ON while an Output Unit (Data Output Unit) in the measurement flow is performed, the Sensor Controller outputs the data of the processing item.	<ul style="list-style-type: none"> The user (PLC) turns this signal ON when requesting the measurement data to output externally. This signal is turned ON at the same time as the Trigger (STEP) or Command Request (EXE) signal switches from OFF to ON. When more than one Output Units is used to output data, turn ON this signal again after the GATE signal for the first data output turns OFF. For details, refer to <i>2-2-14 Timing Chart on page 2-186</i>. 	The user (PLC) switches this signal from ON to OFF when the Sensor Controller turns the Request Completion (EXE) signal ON.*2
XEXE	Flow Command Request Bit	This signal is turned on when a command will be performed while PLC Link flow control is performed.	This signal switches from OFF to ON when an entered command execution is instructed while PLC Link flow control is performed.	This signal switches from ON to OFF when the Flow Command Completion (XFLG) signal is turned ON.

*1. If this EXE signal does not switch from ON to OFF within the "Retry interval" time set in the Ethernet - PLC Link or RS-232C - PLC Link settings after the Command Completion (FLG) signal was turned ON, a timeout error will occur, and the FLG and BUSY signals are forced to be turned OFF.

*2. If this DSA signal does not switch from ON to OFF within the "Retry interval" time set in the Ethernet - PLC Link or RS-232C - PLC Link settings after the Result Completion (GATE) signal was turned ON, a timeout error will occur, and the measurement data prepared for output will be discarded.

● Output Signals

Signal	Signal name	Function	ON/OFF timing	
			OFF to ON	ON to OFF
BUSY	Busy Signal	<p>This signal indicates that external inputs such as a command cannot be accepted. Be sure to issue commands under the condition which this signal is OFF.</p> <p>Note:</p> <ul style="list-style-type: none"> This will not be detected while commands received through any other protocol are processed. <p>(Ex.: This signal remains OFF during measurements with the STEP signal in the Parallel communications.) If you use more than one protocol and need to detect command execution, use the BUSY signal in Parallel.</p> <ul style="list-style-type: none"> “ON” of this signal does not mean that a command is currently performed. To check whether a command is being executed, check the Command Completion (FLG) signal. 	The Sensor Controller turns the signal ON when it receives a command from the user (PLC). (After the EXE signal switches from OFF to ON.)	This signal is turned OFF when the user (PLC) turns the Command Request (EXE) signal.
FLG	Command Completion Signal	The Sensor Controller uses this signal to inform the PLC that a command has been completed.	The signal is turned ON when the Sensor Controller completes execution of a received command.	This signal is turned OFF when the user (PLC) switches the Command Request (EXE) signal from ON to OFF.

Signal	Signal name	Function	ON/OFF timing	
			OFF to ON	ON to OFF
GATE (Used only for handshaking output control)	Data Output Completion Signal	The signal informs the PLC of the timing to load output data. “ON” of this signal indicates that the Sensor Controller is outputting the data. The user (PLC) starts to load data when the signal turns ON.	<ul style="list-style-type: none"> The signal is turned ON after the Sensor Controller performs the Output Unit (Data Output Unit) in the measurement flow *1 and is ready for the data output. Without handshaking, this signal always remains OFF. 	This signal is turned OFF when the user (PLC) switches the Result Set Request (DSA) signal from ON to OFF.
XFLG	Flow Command Completion Bit	This signal indicates that a command performed has been completed during PLC Link flow control performed.	This signal is turned ON when a command performed has been completed (XBUSY switched from ON to OFF) during PLC Link flow control performed.	This signal is turned OFF when the Flow Command Busy (XEXE) signal switches from ON to OFF.
XBUSY	Flow Command Busy Bit	The signal indicates that a command input is in execution during PLC Link flow control performed.	The signal switches from OFF to ON when a command input is in execution during PLC Link flow control performed.	This signal automatically switches from ON to OFF when the Flow command Busy Bit (XEXE) has switched from On to OFF.
XWAIT	Flow Command Wait Bit	This signal indicates that a command input can be accepted during PLC Link flow control performed.	This signal switches from OFF to ON when a command can be entered during PLC Link flow control performed.	This signal switches from ON to OFF when a command cannot be entered during PLC Link flow control performed.

*1. This occurs when the Output Unit is performed after the measurement flow was performed in order from the top, not the moment which measurement execution was completed.

2-2-10 Output Items

Measurement Results for which Output is Possible (Data Output)

The following data can be output using the processing items related to the Result Output. Measurement values are also referred using processing units such as expressions.

Measurement items	Character string	Description
Judgment	JG	Judgment result
Data 0 to 255	D000 to D255	Results of expressions that are set for output data 0 to 255.

External Reference Tables (Fieldbus Data Output)

By specifying a number, the following data can be referred using control commands or processing items having a set and/or get processing unit data function.

Number	Data name	Set/Get	Data range
0	Judgment	Get only	0: No judgment (unmeasured) 1: Judgment result OK -1: Judgment result NG
136	Communication method	Set/Get	0: Ethernet 1: RS-232C
137	Output format	Set/Get	0: ASCII 1: Binary
138	Digits of integer	Set/Get	1 to 10
139	Digits of decimal	Set/Get	0: 0 to 4: 4
140	Minus	Set/Get	0: -, 1: 8
141	Field separator	Set/Get	0: OFF, 1: Comma, 2: Tab, 3: Space, 4: Delimiter
142	Record separator	Set/Get	0: OFF, 1: Comma, 2: Tab, 3: Space, 4: Delimiter
143	0 (zero) suppress	Set/Get	0: No, 1: Yes
144 to 147	Output IP Address 1 to 4 (Only for <i>Ethernet</i>)	Set/Get	Destination IP Address
149	Output IP Address Setting (Only for <i>Ethernet</i>) page 2-176	Set/Get	0: Reference to system 1: Individual specification
150	Output format (Fixed or Floating point)	Set/Get	0: Fixed point 1: Floating point
151	Offset	Set/Get	0 to 99999
152	Number of output data items (Only for PLC Link)	Set/Get	8 to 256
153	Plus	Set/Get	0: No, 1: +
1,000 to 1,255	Data 0 to 255	Get only	ASCII -99,999,999.9999 to 999,999,999.9999 Binary -2,147,483.648 to 2,147,483.647

**Additional Information**

If you are using external reference numbers 5 to 12 on an FZ4 series or earlier model, use 1,000 to 1,007 on the FH/FHV series.

2-2-11 Command List

The following tables list the commands used in PLC Link communications.

For details, refer to *A-1-4 Command Details for PLC Link, EtherNet/IP, EtherCAT, and PROFINET* on page A-16.

- **Execution Commands**

First word in Response Area		Function	Reference
+3	+2		
0010	1010	Performs measurement one time.	page A-16
0010	1020	Performs continuous measurement.	page A-16
0010	1030	Ends continuous measurements.	page A-17
0010	1040	Performs test measurement for the specified unit.	page A-17
0010	2010	Clears all measurement result values.	page A-18
0010	3010	Saves the current system data and scene group data in the Sensor Controller.	page A-20
0010	4010	Registers the model again.	page A-21
0010	5010	Shifts the image display position by the specified amount.	page A-22
0010	5020	Zooms the image display in or out by the specified factor.	page A-23
0010	5030	Returns the display position and display magnification to their default values.	page A-24
0010	7010	Copies the scene data.	page A-25
0010	7020	Deletes the scene data.	page A-25
0010	7030	Moves the scene data.	page A-26
0010	8010	Registers the specified image data as a registered image.	page A-27
0010	8020	Loads the specified registered image as the measurement image.	page A-28
0010	9010	Responds to the Response Area +6 and +7 with the data set in the Command Area +4 and +5.	page A-28
0010	A010	Adds a user account to a specified group ID.	page A-29
0010	A020	Deletes a specified user account.	page A-30
0010	B010	Branches to the start of the measurement flow (processing unit 0).	page A-31
0010	F010	Restarts the Sensor Controller.	page A-31

● Commands to Get Status

First word in Response Area		Function	Reference
+3	+2		
0020	1000	Gets the current scene number.	page A-32
0020	2000	Gets the current scene group number.	page A-32
0020	4000	Gets the number of the layout that is currently displayed.	page A-33
0020	5010	Gets the number of the Unit that is currently displayed in the specified image display window.	page A-34
0020	5020	Gets the sub-image number that is currently displayed in the specified image display window.	page A-34
0020	5030	Gets the image mode for the specified image display window.	page A-35
0020	7010	Gets the input status (prohibited/permitted) for the Communications Modules.	page A-36
0020	7020	Gets the output status (prohibited/permitted) to an external device.	page A-36
0020	8010	Gets the ON/OFF status for the specified parallel I/O terminal.	page A-37
0020	8020	Gets the ON/OFF status of all parallel terminals except for DI terminals.	page A-39
0020	8030	Gets the ON/OFF status of all parallel DI terminals.	page A-41
0020	9000	Gets the user name for the user account currently logged in.	page A-43
0020	9010	Gets the group ID for the account currently logged in.	page A-43
0020	A000	Gets the current state of the operation log.	page A-44

● Commands to Set Status

First word in Response Area		Function	Reference
+3	+2		
0030	1000	Switches to the specified scene number.	page A-45
0030	2000	Switches to the scene group with the specified number.	page A-45
0030	4000	Sets the layout number and switches the image.	page A-46
0030	5010	Sets the number of the Unit to display in the specified image display window.	page A-47
0030	5020	Sets the number of the sub-image to display in the specified image display window.	page A-47
0030	5030	Sets the image mode for the specified image display window.	page A-48
0030	7010	Permits/prohibits inputs to the Communications Modules.	page A-49
0030	7020	Permits/prohibits outputs to external devices.	page A-49
0030	8010	Sets the ON/OFF status of the specified parallel I/O terminal.	page A-50
0030	8020	Sets the ON/OFF status of all parallel terminals except for DO terminals.	page A-52

First word in Response Area		Function	Reference
+3	+2		
0030	8030	Sets the ON/OFF status of all parallel DO terminals.	page A-54
0030	9000	Switches the currently logged in account.	page A-56
0030	A000	Sets the state of the operation log.	page A-57

● Commands to Read Data

First word in Response Area		Function	Reference
+3	+2		
0040	1000	Gets the specified processing unit data.	page A-58
0040	2000	Gets the date and time.	page A-58
0040	3000	Gets the Sensor Controller version information.	page A-59
0040	4000	Gets settings related to image logging.	page A-60
0040	4010	Gets the image logging folder name.	page A-61
0040	4020	Gets the data logging folder name.	page A-62
0040	4030	Gets the screen capture folder name.	page A-63
0040	4040	Gets the prefix for the file name in which logged images are saved.	page A-63
0040	4050	Gets the conditions set for data logging.	page A-64
0040	4060	Gets the parallel DI terminal offset data that is set.	page A-64

● Commands to Write Data

First word in Response Area		Function	Reference
+3	+2		
0050	1000	Sets the specified unit data.	page A-65
0050	2000	Sets the date and time.	page A-66
0050	4000	Changes the settings related to image logging.	page A-67
0050	4010	Sets the name for the image logging folder.	page A-68
0050	4020	Sets the name for the data logging folder.	page A-69
0050	4030	Sets the name for the screen capture folder.	page A-69
0050	4040	Sets the prefix for the file name in which logged images are saved.	page A-70
0050	4050	Sets the data logging conditions.	page A-70
0050	4060	Sets the parallel DI terminal offset data.	page A-71

● File Load Commands

First word in Response Area		Function	Reference
+3	+2		
0060	1000	Loads the scene data.	page A-72

First word in Response Area		Function	Reference
+3	+2		
0060	2000	Loads the scene group data.	page A-73
0060	3000	Loads the system data.	page A-73
0060	5000	Loads the system + scene group 0 data.	page A-74

● File Save Commands

First word in Response Area		Function	Reference
+3	+2		
0070	1000	Saves the scene data.	page A-75
0070	2000	Saves the scene group data.	page A-75
0070	3000	Saves the system data.	page A-76
0070	4000	Saves the image data stored in the the Sensor Controller's memory.	page A-77
0070	4010	Saves all image data in the Sensor Controller's memory with ifz format in external storage.	page A-77
0070	4020	Saves the last logging image.	page A-78
0070	5000	Saves the system + scene group 0 data that is currently used by the Sensor Controller in a file.	page A-79
0070	6000	Captures the screen.	page A-79

2-2-12 Command Response Processing

About control command response processing, the following timing chart describes the ON/OFF timing of signals related to commands to be input.

● Timing Chart for Command Execution

The Command Request (EXE) signal is used as the trigger to input and execute various commands such as measurement execution stored in advance in the external device (such as a PLC) memory.

The Command Completion (FLG) signal turns ON when execution of the control command is completed. Use this as the trigger to turn OFF the Command Request (EXE) signal.

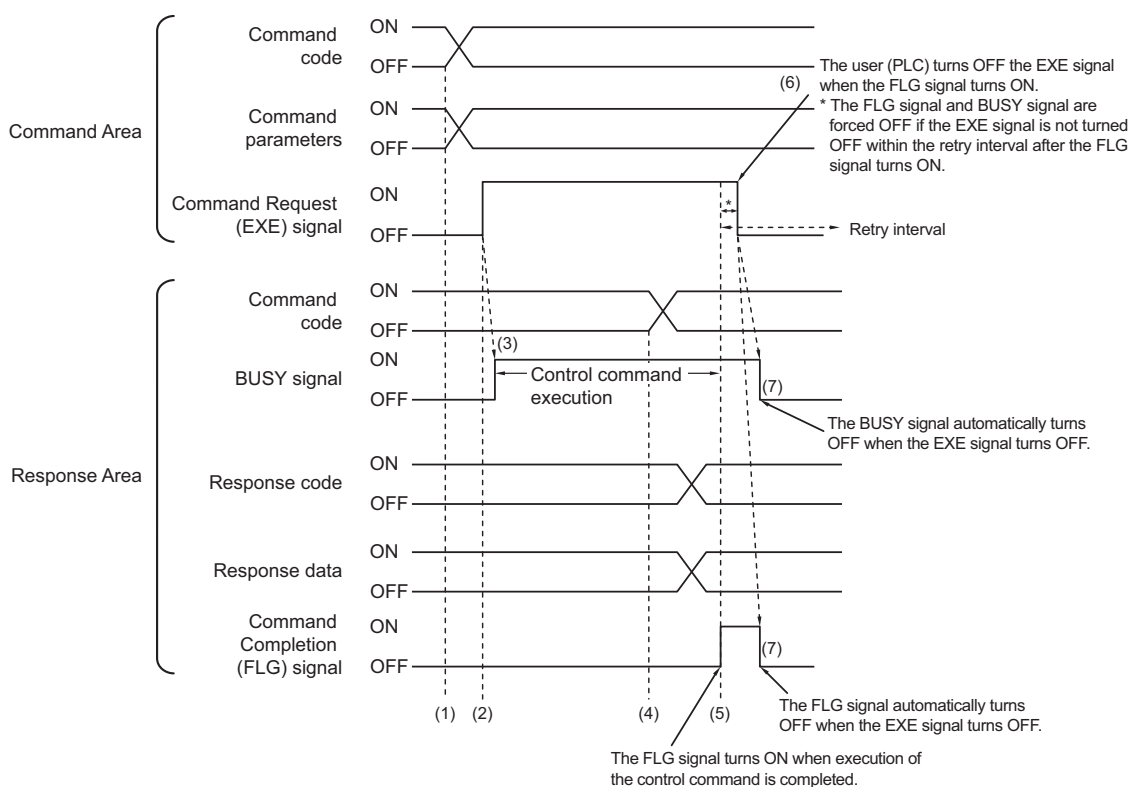

- (1) The external device such as a PLC sets the command code and command parameters.
- (2) After checking that the BUSY signal and the Command Completion (FLG) signal have turned OFF, the PLC turns ON the Command Request (EXE) signal again to instruct the Sensor Controller to perform it.
- (3) When receiving the instruction, the Sensor Controller performs the command and turns ON the BUSY signal.
- (4) When completing the execution, the Sensor Controller sets the command code, response code, and response data.
- (5) The Command Completion (FLG) signal is turned ON.
- (6) The PLC (user) turns OFF the Command Request (EXE) signal when the Command Completion (FLG) signal turns ON.
- (7) When detecting that the Command Request (EXE) signal is OFF, the Sensor Controller automatically turns OFF the Command Completion (FLG) signal and the BUSY signal.

- *1 : A timeout error occurs and the Command Completion (FLG) signal and BUSY signal are forced OFF if the Command Request (EXE) signal is not turned OFF from the PLC (user) within the time set in the PLC Link settings (*Retry interval: 0 to 999999 [ms] for Ethernet PLC Link, or Timeout: 1 to 120 [s] for RS-232C-PLC Link*).

● Timing Chart for Execution of Continuous Measurement Commands (Without handshaking)

Continuous execution is used to repeatedly execute measurement by starting the next measurement operation (image input and measurement processing) as soon as single measurement operation (image input and measurement processing) is completed.

Continuous measurement is started when the Start Continuous Measurements command is executed and ended when the End Continuous Measurements command is executed.

Although the BUSY signal remains OFF during continuous measurement, the Sensor Controller can receive only the End Continuous Measurements command in this state.

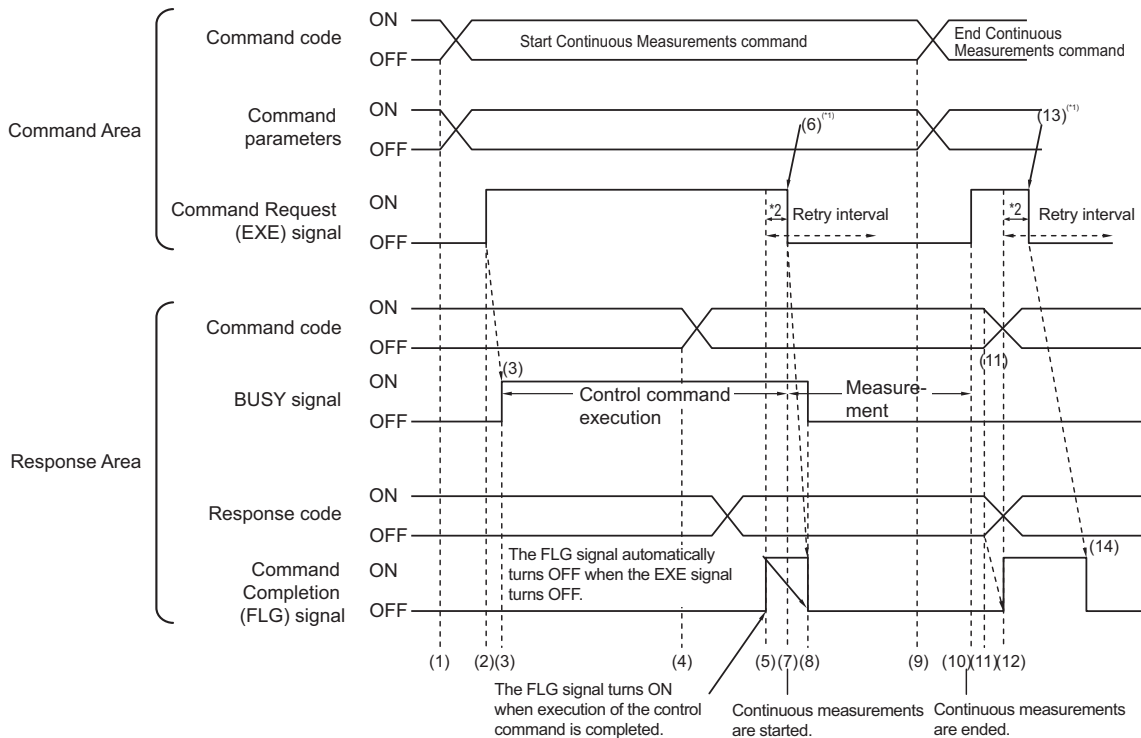

- *1 : When detecting that the Command Completion (FLG) signal turned ON, the PLC (user) turns OFF the Command Request (EXE) signal.

- *2 : The FLG signal and BUSY signal are forced OFF if the EXE signal is not turned OFF within the Retry Interval after the FLG signal turns ON.

<Operation to Start Continuous Measurements>

- (1) The PLC (user) sets the Start Continuous Measurements command code.
- (2) The Command Request (EXE) signal is then turned ON and the instruction is sent to the Sensor Controller.
- (3) When receiving the instruction, the Sensor Controller starts to prepare continuous measurement by turning ON the BUSY signal.
- (4) When completing the preparations for continuous measurement, the Sensor Controller sets the command code and response code. when preparations for continuous measurement have been completed.

- (5) The Command Completion (FLG) signal is turned ON.
 - (6) The PLC (user) turns OFF the Command Request (EXE) signal when the Command Completion (FLG) signal turns ON.
 - (7) After detecting that the Command Request (EXE) signal has turned OFF, the Sensor Controller starts continuous measurement.
 - (8) The Command Completion (FLG) signal and the BUSY signal are then automatically turned OFF.
- *1 : A timeout error occurs and the Command Completion (FLG) signal and BUSY signal are forced OFF if the Command Request (EXE) signal is not turned OFF from the PLC (user) within the time set in the PLC Link settings (*Retry interval: 0 to 999999 [ms]* for Ethernet PLC Link, or *Timeout: 1 to 120 [s]* for RS-232C-PLC Link).

<Operation to End Continuous Measurement>

- (9) The PLC (user) sets the Start Continuous Measurements command code.
- (10) The Command Request (EXE) signal is then turned ON and the instruction is sent to the Sensor Controller.
Continuous measurement are ended.



Additional Information

Continuous measurement is not ended in the middle of measurement. When the End Continuous Measurements command was executed, continuous measurement is ended after the measurement in execution was completed.

<Ending Continuous Measurement>

- (11) The Sensor Controller sets the command code and response code when the continuous measurement stop.
- (12) The Command Completion (FLG) signal is turned ON.
- (13) When detecting that the Command Completion (FLG) signal turns ON, the PLC (user) turns OFF the Command Request (EXE) signal.
- (14) After detecting that the Command Request (EXE) signal has turned OFF, the Sensor Controller automatically turns OFF Command Completion (FLG) signal.



Precautions for Correct Use

- The measurement during continuous measurement is given priority. Therefore, display of the measurement results (total judgment, images, judgment for each processing unit in the flow display, and detailed results) may sometimes not be updated.
- When continuous measurement is ended, the measurement results from the last measurement will be displayed.

2-2-13 Data Output

This section describes the ON/OFF timing for signals related to measurement data output after measurement completion using the following timing chart.

● Without handshaking

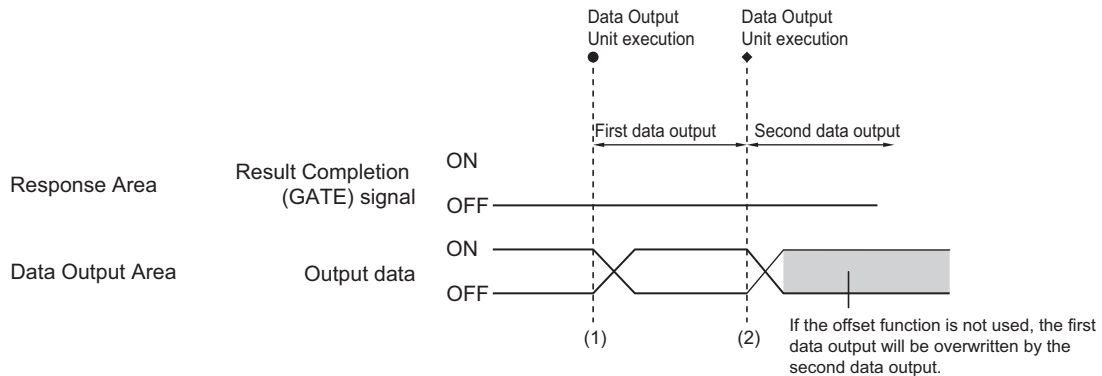

- (1) The Sensor Controller outputs data when the Data Output Unit starts execution.
- (2) Data is output each time that the Data Output Unit is performed for the second time or other Data Output Unit is performed. In that time, the output data for the first time is overwritten.

Therefore, use the offset function of PLC Link when performing multiple Data Output Units without handshaking.

For details, refer to *Output Format (Data Output)* on page 2-330.

● With handshaking

The Result Completion (GATE) signal switches from OFF to ON when the PLC (user) switches the Result Set Request (DSA) signal from OFF to ON.

At that time, data that is possible to output will be output.*1

The PLC (user) switches the DSA signal from ON to OFF under the conditions whether it has received the output data and the Result Completion (GATE) signal has been turned ON.

In the case where multiple Data Output Units perform the data output, the PLC (user) needs to turn the Result Set Request (DSA) signal ON again to instruct next data output when the Sensor Controller switched the Result Completion (GATE) signal from ON to OFF.

*1: Data prepared for output which an Output Unit has been already performed in the measurement flow.

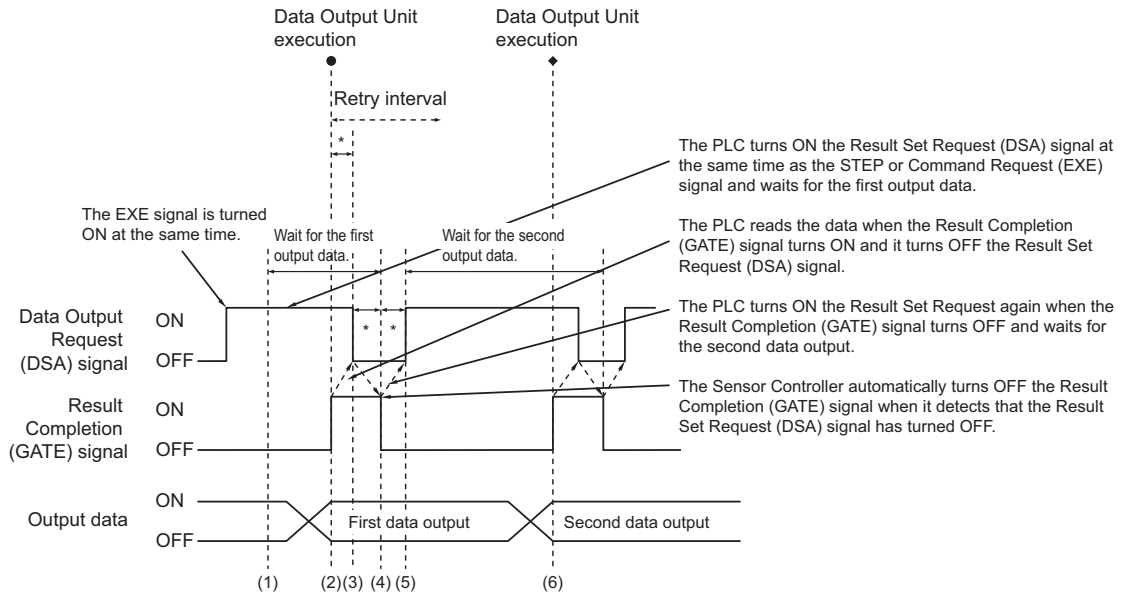

*: A timeout error will occur if the following state exceeds the time, **Retry interval** for Ethernet - PLC Link setting and **Timeout** for RS-232C - PLC Link setting, set in the PLC Link settings.

- If the DSA signal is not turned ON after a certain time passed from when measurement is finished. (Turn the DSA signal ON at the same time as the measurement trigger command is issued.)
- If the DSA signal did not switch from ON to OFF even after a certain time passed from when the GATE signal has switched from OFF to ON.
- If the DSA signal did not switch from OFF to ON even after a certain time passed from when the GATE signal has switched from ON to OFF.

- (1) The PLC (user) turns ON the Command Request (EXE) signal and the Result Set Request (DSA) signal at the same time. The output data for the first Data Output Unit can be surely received.
- (2) The Sensor Controller performs the Data Output Unit in the measurement flow. Since the Result Set Request (DSA) signal is ON, the output data from the Data Output Unit is output to the external device, and the Result Completion (GATE) signal is ON.
- (3) The PLC (user) reads the data when the Result Completion (GATE) signal turns ON and it turns OFF the Result Set Request (DSA) signal.
- (4) The Sensor Controller automatically turns OFF the Result Completion (GATE) signal when it detects that the Result Set Request (DSA) signal has turned OFF.
- (5) If there is more than one Data Output Unit in the measurement flow, the PLC (user) turns ON the Result Set Request (DSA) signal when the Result Completion (GATE) signal turns OFF, and then waits for execution of the next Data Output Unit.
- (6) When the next Data Output Unit is executed, the GATE signal turns ON and the data is output. Receive the second output data and then repeat steps 3 to 5, above. Repeat steps 3 to 5 for any other data outputs.

2-2-14 Timing Chart

This section describes the ON/OFF timing for signals related to the sequence of operation from control command input until measurement data output after measurement completion using the following timing chart.

● Example 1: Inputting a Measurement Command after Switching a Scene without Handshaking

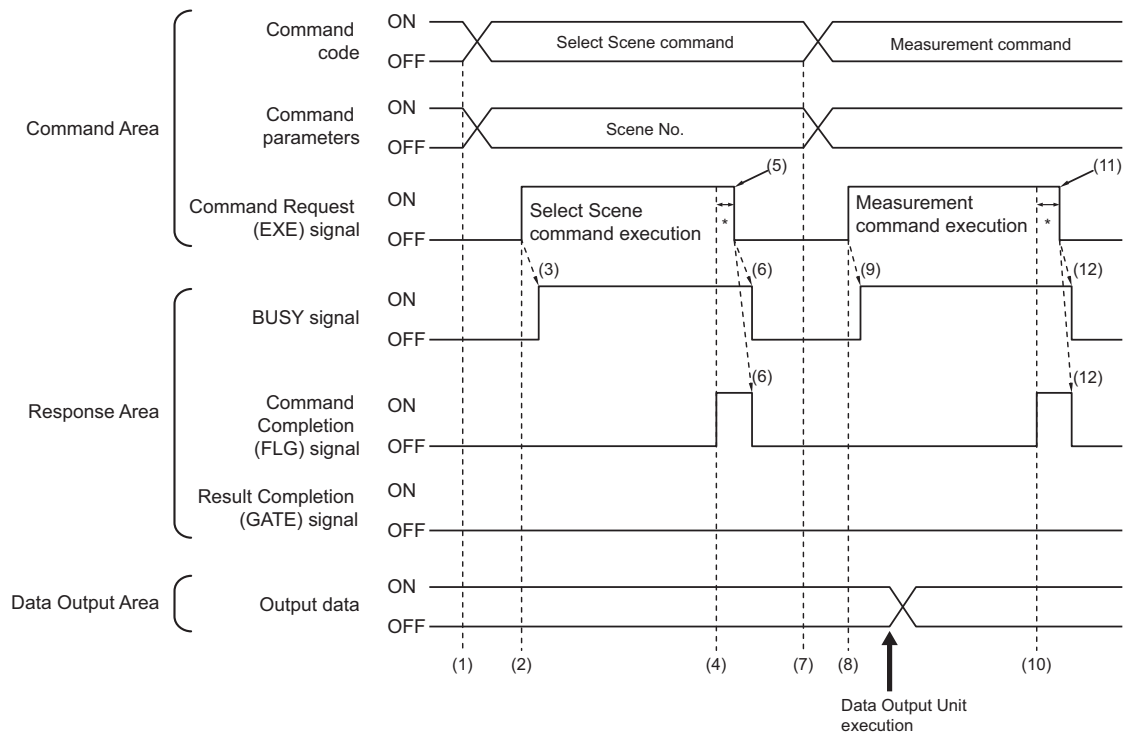

- (1) The external device such as a PLC sets the command code and command parameters for the Switch Scene.
- (2) Next, confirm that the BUSY signal and the Command Completion (FLG) signal have turned OFF and then turn ON the Command Request (EXE) signal. A request is sent to the Sensor Controller.
- (3) The Sensor Controller turns ON the BUSY signal and switches the scene when the request is received.
- (4) The Command Completion (FLG) signal is turned ON when the scene switching is completed.
- (5) The PLC (user) turns the Command Request (EXE) signal OFF when the Command Completion (FLG) signal is switched from OFF to ON.
- (6) When the Sensor Controller detects that the Command Request (EXE) signal is OFF, it automatically turns OFF the Command Completion (FLG) signal and the BUSY signal.
- (7) The measurement command code and command parameters are set from the external device such as a PLC.
- (8) The Command Request (EXE) signal is turned ON to execute the measurement command.



Additional Information

To execute a measurement trigger after changing the scene, first confirm that the Command Completion (FLG) signal and the BUSY signal that turned ON for execution of the Select Scene command have turned OFF.

Also, if the BUSY signal is ON for too little time and the external device cannot read it, increase the time that the BUSY signal is ON for changing scenes so that the external device can read the ON state. To do this, change the *Add time* setting for the *Scene switch time*.

Refer to *Setting the Conditions That Are Related to Operation during Measurement* in the *Vision System FH/FHV Series User's Manual (Cat. No. Z365)*.

- (9) The Sensor Controller turns ON the BUSY signal and executes measurement processing when the request is received.
- (10) The Command Completion (FLG) signal is turned ON when the measurement processing was completed.
- (11) The PLC (user) turns the Command Request (EXE) signal OFF when the Command Completion (FLG) signal turns ON.
- (12) When the Sensor Controller detects that the Command Request (EXE) signal is OFF, it automatically turns OFF the Command Completion (FLG) signal and the BUSY signal.

When the Command Request (EXE) signal does not switch from ON to OFF within the *Retry interval* time set in the Ethernet - PLC Link or the *Timeout* time set in the RS-232C - PLC Link settings, a timeout error will occur, and the FLG and BUSY signals are forced to be turned OFF.

● **Example 2: Outputting Data with more than one Output Unit Without Hand-shaking**

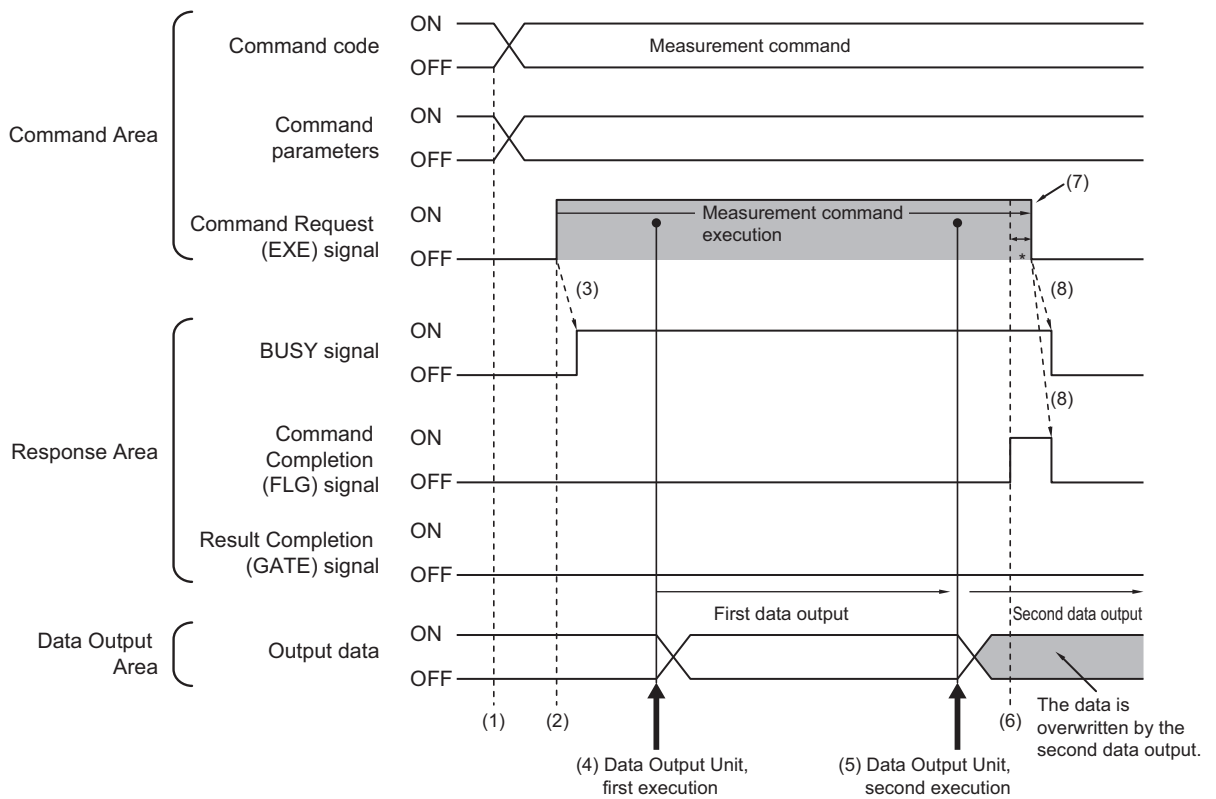

- (1) The measurement command code and command parameters are set from the external device such as a PLC.
- (2) Next, confirm that the BUSY signal and the Command Completion (FLG) signal have turned OFF and then turn ON the Command Request (EXE) signal. A request is sent to the Sensor Controller.

- (3) The Sensor Controller turns ON the BUSY signal and executes measurement processing when the request is received.
- (4) When the first Data Output Unit in the measurement flow is executed, the output data for the first Data Output Unit is output to the position at the specified offset in the Data Output Area.
- (5) When the second Data Output Unit in the measurement flow is executed, the output data for the second Data Output Unit is output to the position at the specified offset in the Data Output Area. If no offset has been set, the data will overwrite the data from the first Data Output Unit in the same Data Output Area.
- (6) The Command Completion (FLG) signal is turned ON when the measurement processing was completed.
- (7) The PLC (user) turns the Command Request (EXE) signal OFF when the Command Completion (FLG) signal turns ON.
- (8) When the Sensor Controller detects that the Command Request (EXE) signal is OFF, it automatically turns OFF the Command Completion (FLG) signal and the BUSY signal.
When the Command Request (EXE) signal does not switch from ON to OFF within the *Retry interval* time set in the Ethernet - PLC Link or the *Timeout* time set in the RS-232C - PLC Link settings, a timeout error will occur, and the FLG and BUSY signals are forced to be turned OFF.



Additional Information

Saving All of the Measurement Results

If you output data from more than one Data Output Unit or for repeatedly measured output data (e.g., for continuous measurements), the same Data Output Area will be overwritten.

If you want to save all output data, use one of the following methods.

Method	Description
Offset (PLC Link Communications Only)	When using more than one Output Unit, you can offset the write destination of the output data for each Output Unit. Set the Offset for the Data Output processing item. For details, refer to <i>Output Format (Data Output)</i> on page 2-158. This function is enabled when you are performing data output from more than one Data Output Unit.
Controlling Data Output with Handshaking	Handshaking lets you control data output by using the GATE signal turning ON as a trigger for the data output timing and by turning ON the DSA signal to read the output data. Each time that data is output (from the second output on), read the output data and move it to a different part of I/O memory in the external device such as a PLC. For details, refer to <i>Data Output Control with Handshaking</i> on page 1-24.

You can compare the received number of output data and the number of measurements for continuous measurements to check if all of the measurement results have been received. Use the following method to check the number of measurements that was actually executed.

- Application Example

Set a calculation to count the number of measurements that are executed in the measurement flow.

If you set something like [DO+1], each time a measurement is executed (each time the measurement flow is executed), 1 will be added to DO, so the present value of DO will give you the actual number of measurements.

2-2-15 PLC Link Troubleshooting

● **Cannot Input to the Sensor Controller (RS-232C Only)**

Problem	Cause	Action
No response is received after sending communication commands.	The wiring is incorrect.	Check the wiring. Check the cable connections.
	The RS-232C settings are incorrect.	Correct the settings.
No response is received after sending communications commands. (Communications were properly working previously.)	Commands are sent while the BUSY signal is ON.	Send commands while the BUSY signal is OFF.
	A cable is broken.	Check the cable connections.
	A connector has been disconnected.	Check the connector connections.

● **No Data is Output from Sensor Controller**

Problem	Cause	Action	
The GATE signal does not turn ON.	Handshaking is disabled. (The GATE signal is not output when handshaking is not set in PLC Link.)	Set handshaking for the output control in the communication settings.	
	The DSA signal is not ON (when handshaking is enabled.)	Turn the DSA signal ON from the PLC.	
Data is not output at all.	Ethernet	The output IP address is incorrect.	Set the output IP address correctly.
	RS-232C	Wrong wiring or A cable is broken.	Check the wiring. Check the cable.
		A connector has been disconnected.	Check the connector connections.
		No Data Output processing items are set in the measurement flow.	Place Data Output processing items in the measurement flow.
	The <i>Output</i> option is not selected in the Adjustment window.	Place a check to the <i>Output</i> option in the Adjustment window.	
Data is sometimes output and sometimes not.	Ethernet	The measurement commands have not been accepted.	If the BUSY signal stays OFF after a measurement command is issued, the measurement command may have not been accepted. Issue measurement commands only when both of the BUSY and FLG signals are OFF.
	RS-232C/422	A cable is broken.	Check the cable.
		The <i>Output</i> option is not selected in the Adjustment window.	Place a check to the <i>Output</i> option in the Adjustment window.
	The measurement commands have not been accepted.	If the BUSY signal stays OFF after a measurement command is issued, the measurement command may have not been accepted. Issue measurement commands only when both of the BUSY and FLG signals are OFF.	

Problem	Cause	Action
The read or collated string is not output.	Character output has not been set.	Set character output in the output parameters for the character output processing items such as Character Inspection, Barcode, 2DCode. (The output for the read or collated string is set in the above processing items, not in the Data Output processing items.)
Although more than one Data Output item is set in the measurement flow, data is received from only the last Data Output Unit in the flow.	The data output by the Data Output Unit has been overwritten by the next Data Output Unit.	Use handshaking to control the data output or use an offset to store all data.

● **A Timeout Error Occurred**

Problem	Cause	Action
A handshaking timeout error occurred.	The timing to switch the DSA signal is too slow. The following patterns are considered. <ul style="list-style-type: none"> • The DSA signal is not turned ON even after measurement has been completed. • The DSA signal is not switched from ON to OFF even after the GATE signal has been turned ON. • The DSA signal is not turned ON even after the GATE signal has been turned OFF. 	Turn the DSA signal ON or OFF within the time set as the timeout.
	The DSA signal is not output or detecting its state by the Sensor Controller is late.	Check the timing when the PLC program instructs to output the DSA signal. The signal may not be received correctly due to noise.

● **Slow Operation**

Problem	Cause	Action
It takes around 10 seconds to perform any PLC Link command.	Communications have timed out.	Set the PLC cycle time as short as possible.
Response and data output is slow.	You try to use a wrong combination for communication protocols such as PLC Link and EtherNet/IP or PLC Link and PROFINET.	Use a proper combination for communication protocols.
	Asynchronous output is selected without output control.	To select asynchronous output, set the output control to [Handshaking]. Clear the option for Asynchronous output if no output control.

- **A PLC Link Error Occurred**

Problem	Cause	Action
A message of "PLC Link Error" is displayed.	You try to use a wrong combination for communication protocols such as PLC Link and EtherNet/IP or PLC Link and PROFINET.	Use a proper combination for communication protocols.
	The communication settings such as the port settings have been changed on the PLC.	Restart the PLC.

- **The Sensor Controller cannot Communicate with a PLC Properly. (Only for Ethernet)**

Problem	Cause	Action
The Sensor Controller cannot communicate with an external device such as a PLC properly. (Only for Ethernet)	The communication settings such as IP address have been changed after the Device information storage tool was performed. (The IP addresses for external devices on the network may have overlapped the IP addresses stored in the Sensor Controller.)	Check that the communication settings such as IP address are correct. (Tool menu - System setting - Communication - Ethernet) Perform the Device information storage tool again. The communication settings in the software will be copied in the Sensor Controller.

2-3 Communicating by EtherNet/IP

This section describes the communication settings, communication specifications, input/output formats, and the communication timing charts during communications, which are required for EtherNet/IP communications between the Sensor Controller and an external device.

2-3-1 Introduction to EtherNet/IP

EtherNet/IP is an industrial multi-vendor network using Ethernet.

The specifications are open standards managed by the ODVA (Open DeviceNet Vendor Association). EtherNet/IP is used in a wide range of industrial devices.

Since EtherNet/IP uses standard Ethernet technology, it can be mixed with various general-purpose Ethernet devices.

EtherNet/IP has mainly the following features.

- **High-speed and high-capacity data exchange through tag data links (Cyclic communication)**
The EtherNet/IP protocol supports Implicit communications, which allows cyclic communication so-called tag data links with EtherNet/IP devices.
- **Tag data links at communication cycle specified for each application regardless of the number of nodes**

Since data is exchanged over the network at the update period set for each connection, the update period for communications will not increase even if the number of nodes is increased. (The concurrency of data in connections is maintained.)

Moreover, the update period can be set for each connection, each application can communicate at its optimum update period. (ex.: Interprocess interlocks can be transferred at high-speed, while production instructions and the status monitor information for production processes are transferred at low-speed.)



Precautions for Correct Use

- On a network to which many devices are connected, performance may drop (e.g., responses may be delayed or packets lost) or communications errors may occur when there is temporarily high traffic on the network. Test the operation under actual conditions before you start actual operation of the system.
- Since a reasonable amount of measurement takt time is required to have stable communications in an operation under high load, verify the operation under the conditions that are to be actually applied.
- Use Ethernet connector 2 (the bottom connector) to perform EtherNet/IP communications with the following series:
 - FH-2000 series
 - FH-5000 series
 You cannot use EtherNet/IP communications with Ethernet connector 1 (the top connector).
- Connection using Multi-line Random Trigger Mode is not possible with the external device such as a PLC. In Multi-line Random Trigger Mode, the sensor controller assigns a connection to each line. On the external device such as a PLC, multiple connections cannot be set. Check and verify the external device such as a PLC specifications prior to use.
- When using EtherNet/IP communications in Multi-line Random-trigger mode with three lines or more, recommend using FH-5000 series because it is likely to be a high-load state.

2-3-2 Data Exchange with EtherNet/IP

Communications with EtherNet/IP

Data is cyclically exchanged between Ethernet devices on the EtherNet/IP network with tag data links below.

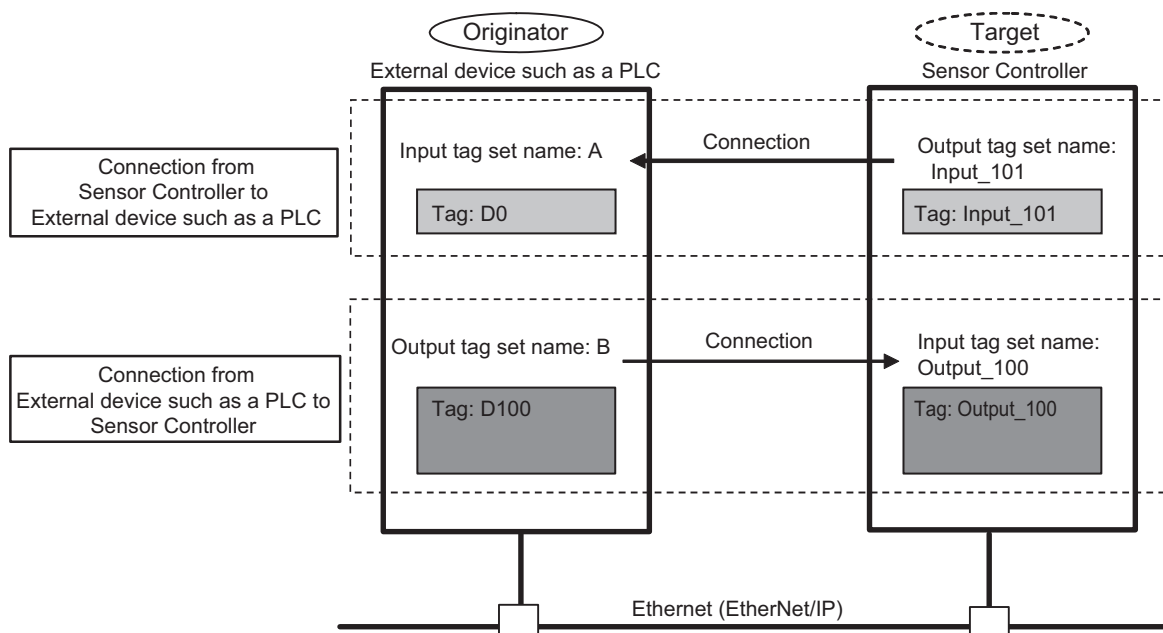

- **Data exchange method**

To exchange data, a connection is opened between two EtherNet/IP devices.

One of the nodes requests the connection to open a connection with a remote node.

The node that requests the connection is called the *Originator*, and the node that receives the request is called the *Target*.

- **Data exchange memory locations**

The memory locations used to exchange data across a connection are specified as tags.

Memory locations or variables can be specified to tags.

These grouped tags are called an output tag set and input tag set respectively.



Additional Information

Message communications are used when communicating with an external device such as a PLC that does not support tag data link communications or when using functions, such as character string output, that are not supported in tag data link communications.

For details of EtherNet/IP message communications, refer to *2-3-19 Communicating with the Sensor Controller using EtherNet/IP Message Communications* on page 2-253.

EtherNet/IP Communication Cycle (RPI)

The tag data link communications by EtherNet/IP update data at a communication interval called RPI (Requested Packet Interval).

All data exchange between the Sensor Controller and an external device such as a PLC is performed at the set RPI.

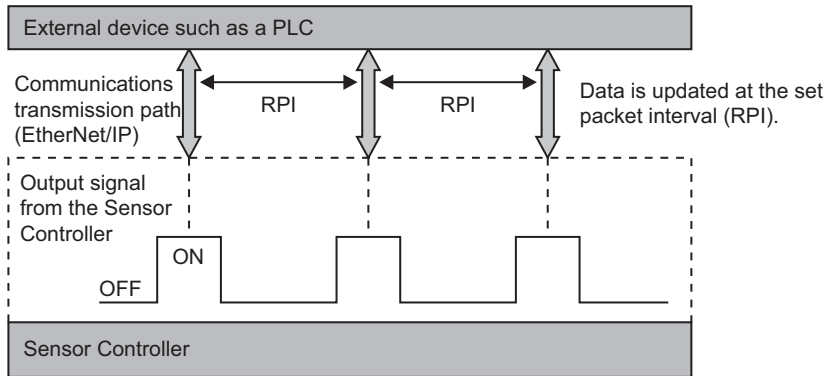

As changes in each signal from the Sensor Controller are also affected by the RPI, the target device sometimes may not detect such changes depending on the RPI timing.

Therefore, set the relationship between the output signals from the Sensor Controller and the RPI as follows.

Duration of change in Sensor Controller signal > RPI



Precautions for Correct Use

Set the RPI to 4 [ms] or higher.

When the RPI is longer than the duration of a Sensor Controller signal change, the signal change may not be detected.

Example 1: Duration of Change in Sensor Controller Signal < RPI

RPI		30 ms
Sensor Controller	Output period	50 ms
	Output time	30 ms (ON: 30 ms, OFF: 20 ms)
	Output control	None

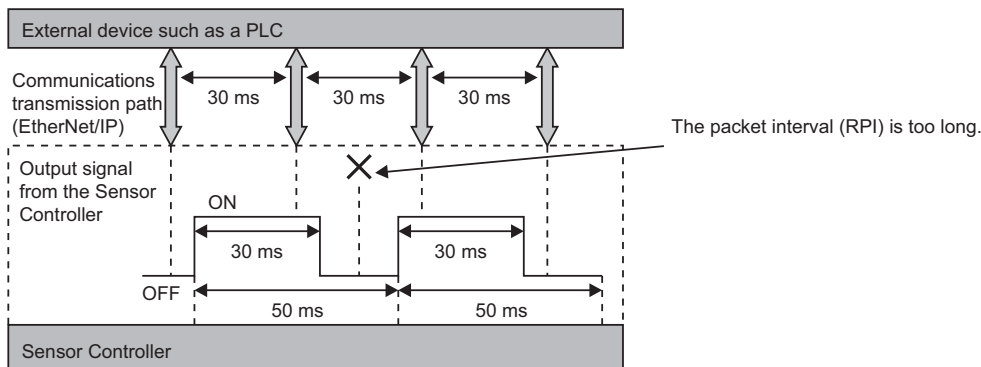

The external device such as a PLC cannot detect some of the output signals from the Sensor Controller.

Example 2: Duration of Change in Sensor Controller Signal > RPI

RPI		10 ms
Sensor Controller	Output period	50 ms
	Output time	30 ms (ON: 30 ms, OFF: 20 ms)
	Output control	None

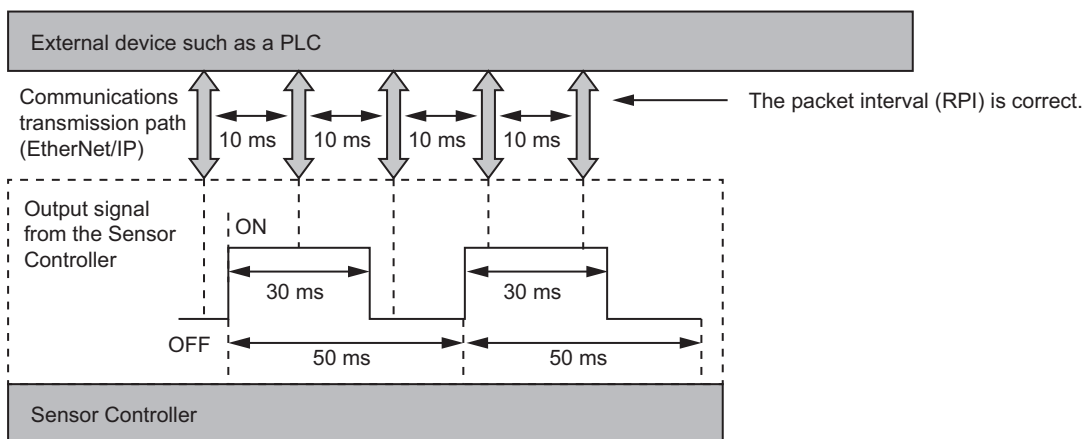

The RPI is shorter than the signal time (GATE OFF: 20 [ms]), so the external device such as a PLC can detect all output signals from the Sensor Controller.



Additional Information

Set the communications settings as follows:

- Sensor Controller communications settings: Set *Output period* and *Output time* in the EtherNet/IP settings.
For details, refer to *Setting the EtherNet/IP Output Specifications* on page 2-204.
- RPI setting: Set the RPI using Support Software that can set tag data link settings (e.g., Network Configurator).
For details, refer to *2-3-8 Setting Tag Data Link* on page 2-208.

2-3-3 EtherNet/IP Communications

With commands and responses via communications between the external device such as a PLC and the Sensor Controller using EtherNet/IP tag data link, the external device such as a PLC can control the Sensor Controller and make it output data after measurements.

The Sensor Controller supports EtherNet/IP conformance tests.

The settings for tag data links are performed with the support software dedicated to it.

When you connect to an OMRON Controller to communicate with it via EtherNet/IP, use the Network Configurator to perform the tag data link settings such as tag, tag set, and connection setting.

This section describes how to use the Network Configurator to perform tag data link settings.

For details of the tag data link settings using Network Configurator, refer to the following manuals.

- *NJ-series CPU Unit Built-in EtherNet/IP Port User's Manual (Cat. No. W506)*
- *CS/CJ series EtherNet/IP Units Operation Manual (Cat. No. W465)*
- *CJ-series EtherNet/IP Units Operation Manual for NJ-series CPU Unit (Cat. No. W495)*



Precautions for Correct Use

- Since a reasonable amount of measurement takt time is required to have stable communications in an operation under high load, verify the operation under the conditions that are to be actually applied.
- On a network to which many devices are connected, performance may drop (e.g., responses may be delayed or packets lost) or communications errors may occur when there is temporarily high traffic on the network. Test the operation under actual conditions before you start actual operation of the system.
- When the measurement interval is short, the measurement processing load is high, or command processing for operations such as scene group changing is time-consuming, the Sensor Controller prioritizes measurement processing and control processing over communication processing. As a result, communication between an external device and the Sensor Controller may be temporarily interrupted, and a communication error may occur.

In this case, set the communication error timeout time longer than the Sensor Controller's processing time, or lengthen the measurement interval. Set the communication error timeout time in the tag data link connection settings*1 as follows:

Timeout value > Measurement time on Sensor Controller.

*1: Use Support Software, such as the Network Configurator, to change the tag data link connection settings.

For details of setting the tag data links using the Network Configurator, refer to 2-3-8 *Setting Tag Data Link* on page 2-208.

2-3-4 Communications Processing Flow

In EtherNet/IP communications, the following five communication areas are set in the external device such as a PLC.

Input tag set for the Sensor Controller	(1) Command Area (Command/response method)	This area is used that you write control commands to perform for the Sensor Controller.
	(2) User Input Area 0	This area is used that you write the data that you defined for the Sensor Controller.
Output connection to external device such as a PLC	(3) Response Area (Command/response method)	This area is used that the Sensor Controller writes the results which the control commands written in the Command Area were performed.
	(4) Data Output Area (Data output after measurement)	This area is used that the Sensor Controller writes the output data accompanied with the measurement after measurement performed.
	(5) User Output Area	This area is used that the Sensor Controller writes the data that you defined.

The above five areas are set by Support Software that can perform tag data link settings such as Sysmac Studio Ver. 1.10 or later, or Network Configurator. How to specify is either I/O memory addresses or variable names.

For details of the tag data link settings by Network Configurator, refer to *2-3-8 Setting Tag Data Link* on page 2-208.

Moreover, when a non-OMRON PLC or EtherNet/IP unit is connected, download the EDS file for the Sensor Controller from our OMRON website and follow the procedures in the user's manual for the external devices to be connected and in the instruction for the software to set tag data link.

The flow of EtherNet/IP communications between an external device such as a PLC and the Sensor Controller is as follows.

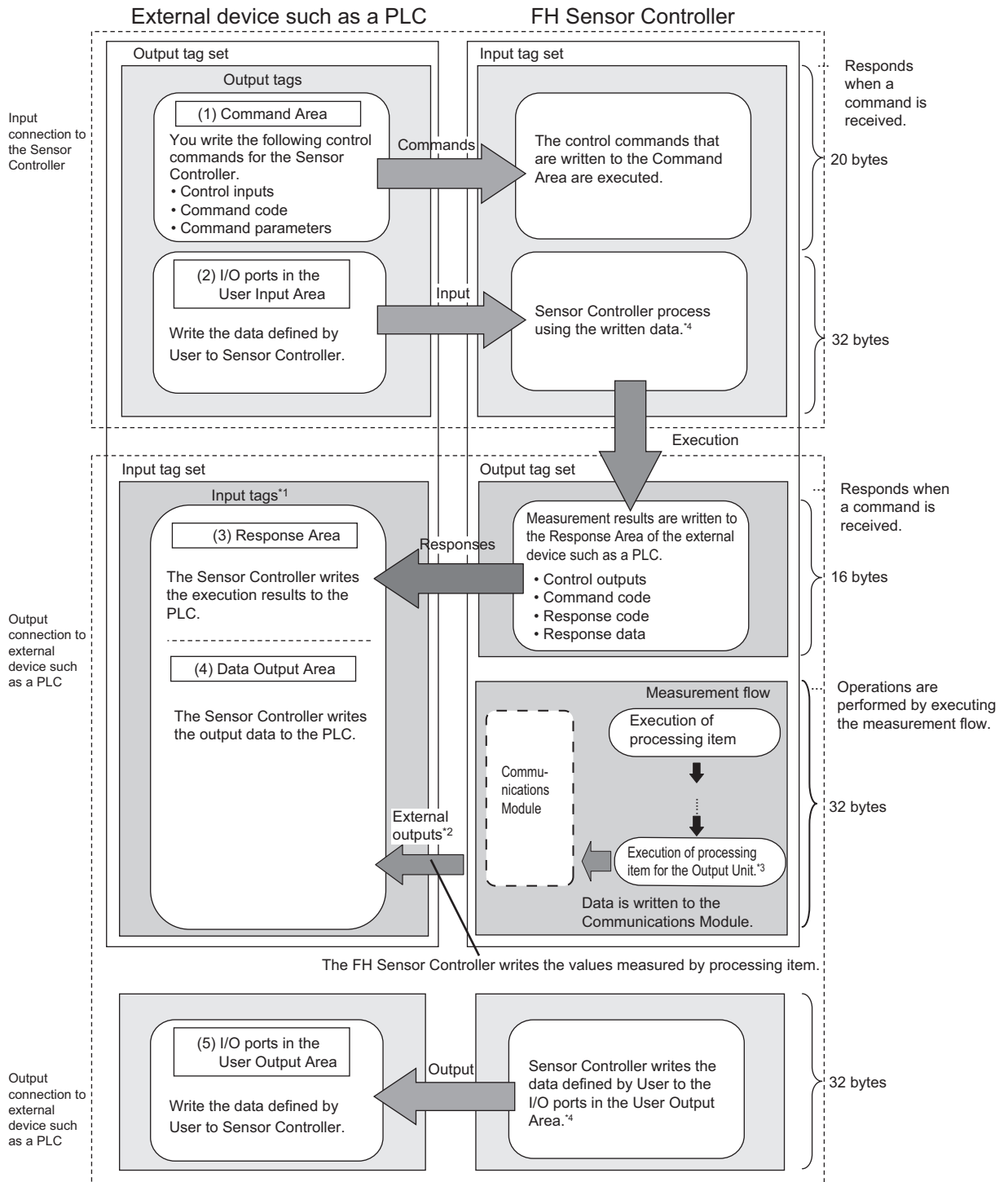

- *1 : The Response Area (3) and Data Output Area (4) are assigned to continuous memory addresses or to variables.
- *2 : You can use output controls (handshaking) to prevent output data from being externally output from the communications buffer until the PLC (master) turns ON the Result Set Request (DSA) signal to request the output data.
- *3 : For details of the Output Units outputting measurement data, refer to *Settings Required for Data Output* on page 1-20.
- *4 : Use the Macro Customization Function to input and output to the User Area. For details of the Macro Customization Function, refer to *EtherNet/IP communication of the IO Module List* in the *Vision System FH/FHV Macro Customize Functions Programming Manual (Cat. No. Z367)*.

2-3-5 Communications Settings

The following settings are required to use EtherNet/IP communications.

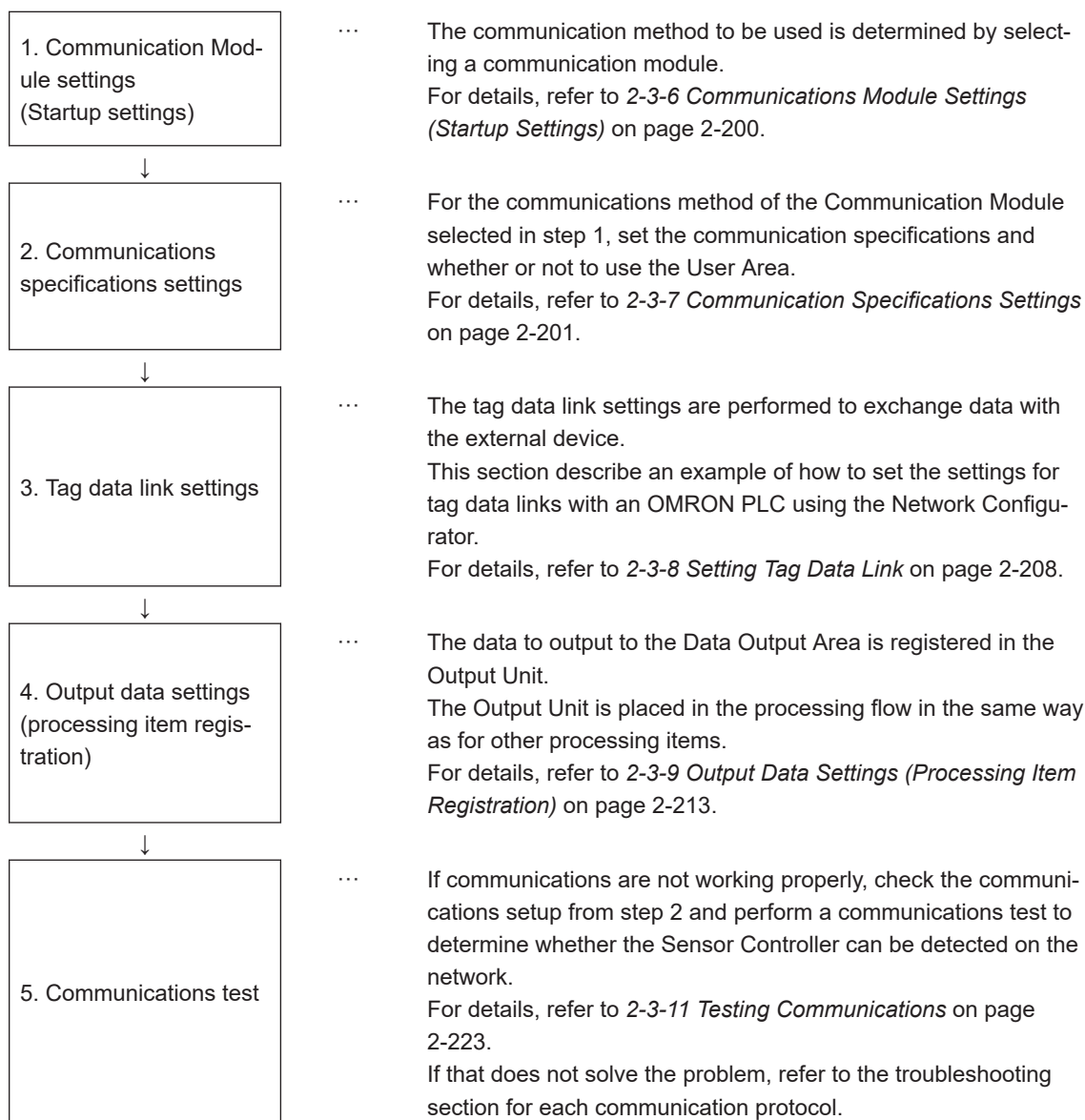

2-3-6 Communications Module Settings (Startup Settings)

The communication method used for communication with the Sensor Controller is selected from the communication modules.

- 1 On the Main window, click **Tool - System Settings** to open the system settings.
- 2 On the Multiview Explorer on the left, select **System settings - Startup - Startup setting** and then click the **Communication** tab.

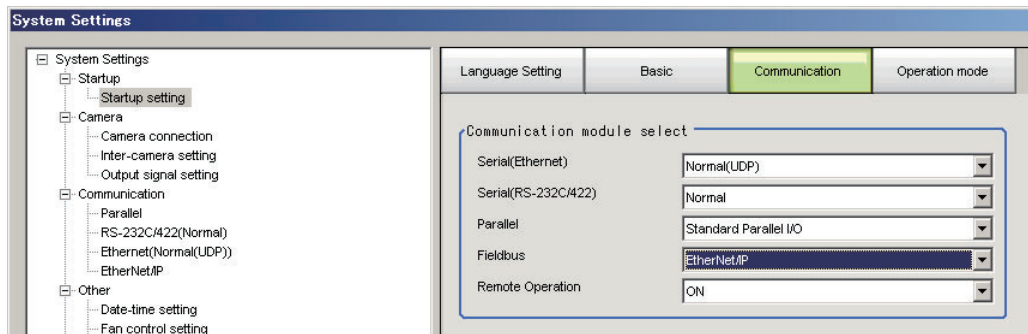

- 3 In the Communication Module Selection Area, select *EtherNet/IP* in the *Fieldbus*, and then click **Apply**.
- 4 Click **Data save** in the Toolbox Pane.

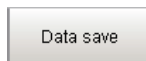

- 5 On the Main window, click **Function - System restart**.
- 6 Click **OK** in the System restart dialog box to restart the Sensor Controller. When the Sensor Controller was restarted, the set Communication Module will operate with the default settings.
- 7 Set the IP address and other parameters for external devices such as a PLC.



Precautions for Correct Use

After you set the Communication Module, always click **Data save** and then restart the Sensor Controller. If the settings are not saved and the Sensor Controller is not restarted, the new Communication Module settings will not be enabled



Additional Information

You can save the Communication Module settings to a file. Use the *System data* or *System + Scene group 0 data* option for *saving settings to a file*. For details, Refer to *Saving Settings Data to the Controller RAM Disk or an External Storage Device* in the *Vision System FH/FHV Series User's Manual (Cat. No. Z365)*.

2-3-7 Communication Specifications Settings

Set the output handshaking and output controls for communications.



Precautions for Correct Use

- Set the Communications Module to *EtherNet/IP* in the startup settings before setting the communications specifications.
For details, refer to 2-3-6 *Communications Module Settings (Startup Settings)* on page 2-200. After you select the Communications Module, save the settings to the Sensor Controller and restart the Sensor Controller. If you do not restart the Sensor Controller, the selected Communications Module will not be enabled.
Furthermore, if the operation mode is set to the Multi-line Random-trigger Mode, the Communications Modules for lines 1 and higher must also be set to *EtherNet/IP*.
- When using Multi-line Random-trigger Mode, specify different addresses for the sending and receiving areas for each line.
- After the tag data link was set, the Sensor Controller automatically restarts to reflect the setting.

Setting IP Address

- 1 On the Main window, click **Tool - System Settings** to open the system settings.
- 2 In the tree view on the left, select **System Settings - Communication - Ethernet Normal (xyz)** ("xyz" depends on the Communication Module).
The Ethernet view is displayed.
- 3 Set each item.
 - UDP case



Additional Information

- Sensor Controllers of the FH-2000 / FH-5000 series have two Ethernet ports.
Set the settings for the two Ethernet ports as follows:
 - Communication Module Settings:
Use the same settings for both ports
 - IP Address Setting:
Set a different IP address for each Ethernet port.
The IP address for the top Ethernet port is set in *Address setting*, and the IP address for the bottom Ethernet port is set in *Address setting 2*. Note that the Sensor Controller prioritizes the bottom port, so when there is a high network load, communication on the top port may be delayed or in some cases communication data may be lost. By using both Ethernet ports simultaneously, you can use the bottom port for PLC Link, Non-procedure, EtherNet/IP, or PROFINET communications with an external device such as a PLC and the top port for FTP or remote operation communications with an external device.
- The following Sensor Controller type has one Ethernet port:
 - FH-L/FHV series
 In this case, the IP address of the Ethernet port is set in *Address setting 2*

Setting item	Setting value [Factory default]	Description
Address Settings Address Settings is only for the following series: FH-2000 / FH-5000 series		Set the IP address for the upper Ethernet port on the Sensor Controller.
	<ul style="list-style-type: none"> • Obtain an IP address automatically. • [Use the following IP address] 	Set the IP address for the Sensor Controller. When <i>Obtain an IP address automatically</i> is selected, the IP address of the Sensor Controller will be automatically obtained. When <i>Use the following IP address</i> is selected, set the IP address, subnet mask, and the default gateway address.
IP Address	a.b.c.d a: 1 to 223 b: 0 to 255 c: 0 to 255 d: 0 to 254 [10.5.5.100]	Enter the IP address for the Sensor Controller.
Subnet mask	0.0.0.0 to 255.255.255.255 [255.255.255.0]	Enter the subnet mask address.
Default gateway	a.b.c.d a: 1 to 223 b: 0 to 255 c: 0 to 255 d: 0 to 255 [10.5.5.100]	Enter the default gateway address.
DNS server	a.b.c.d a: 1 to 223 b: 0 to 255 c: 0 to 255 d: 0 to 255 [10.5.5.100]	Enter the DNS server address.

Setting item	Setting value [Factory default]	Description
Preferred WINS server	a.b.c.d a: 1 to 223 b: 0 to 255 c: 0 to 255 d: 0 to 255 [0.0.0.0]	Enter the WINS server address.
Alternate WINS server	a.b.c.d a: 1 to 223 b: 0 to 255 c: 0 to 255 d: 0 to 255 [0.0.0.0]	Enter the WINS server address.

Setting item	Setting value [Factory default]	Description
Address Settings 2 Address Settings is only for the following series: FH-2000 / FH-5000 / FH-L / FHV series		Set the IP address for the lower Ethernet port on the Sensor Controller.
	<ul style="list-style-type: none"> Obtain an IP address automatically. [Use the following IP address] 	
IP Address	a.b.c.d a: 1 to 223 b: 0 to 255 c: 0 to 255 d: 0 to 254 [10.5.6.100]	Same as "Address Settings".
Subnet mask	0.0.0.0 to 255.255.255.255 [255.255.255.0]	
Default gateway	a.b.c.d a: 1 to 223 b: 0 to 255 c: 0 to 255 d: 0 to 255 [10.5.6.100]	
DNS server	a.b.c.d a: 1 to 223 b: 0 to 255 c: 0 to 255 d: 0 to 255 [10.5.6.100]	
Preferred WINS server	a.b.c.d a: 1 to 223 b: 0 to 255 c: 0 to 255 d: 0 to 255 [0.0.0.0]	

Setting item	Setting value [Factory default]	Description
Alternate WINS server	a.b.c.d a: 1 to 223 b: 0 to 255 c: 0 to 255 d: 0 to 255 [0.0.0.0]	Enter the WINS server address.

Setting item	Setting value [Factory default]	Description
Input and Output settings		
Output IP Address/TCP Server* ¹	a.b.c.d a: 1 to 223 b: 0 to 255 c: 0 to 255 d: 0 to 254 [0.0.0.0] / [10.5.5.101]* ¹	Enter the IP address for the output destination.
Input/Output port No.	0 to 65,535* ² [9,600] / [9,876]* ³	Set the port number to use for the data input and output with the Sensor Controller.

*1. When the TCP is used for the connection, *TCP Server* is displayed. Factory default settings are [10.5.5.101].

*2. When the UDP is used for the connection, do not set the port numbers from "9,700" to "9,700 + line number".

*3. When the TCP is used for the connection, Factory default settings are [9,876].

- 4** Click **Apply** to finish the settings.
Click **Close** to close the System Settings dialog.



Precautions for Correct Use

- If the operation mode is set to **Multi-line Random-trigger Mode**, set a different I/O port number for each line.
- Change the IP address and subnet mask for **Address setting** and **Address setting 2** as required so that each designate a different network address. If the same network address were specified, communications may not be performed correctly.
- Be sure to change the output IP address from its factory default value in accordance with your network environment.

Setting the EtherNet/IP Output Specifications

- 1** On the Main window, click **Tool - System Settings** to open the system settings.
- 2** Select **System Settings** → **Communication** → **EtherNet/IP**.
The Ethernet view is displayed.
- 3** Set each item.

Setting

Judge output polarity:

Error output polarity:

Output control:

We recommend the use of "Handshaking".
If "None" is selected, there is a possibility that external device transmit and receive data is not executed properly at high load environment.

Output period [ms]:

Output time [ms]:

Timeout [s]:

Output data size: User Area

Setting item	Setting value [Factory default]	Description
Judge output polarity	<ul style="list-style-type: none"> ON at OK [ON at NG] 	ON at OK: ON when the judgment result is OK. For the overall judgment, ON when all judgment results are OK. ON at NG: ON when the judgment result is NG. For the overall judgment, ON when one of the judgment results is NG.
Error output polarity	<ul style="list-style-type: none"> [ON at error] OFF at error 	ON at error: ON when an error occurs. OFF at error: OFF when an error occurs.
Output control	<ul style="list-style-type: none"> [None] Handshaking 	Set whether to synchronize with the external device when data is output. Normally, select <i>Handshaking</i> . For details, refer to 2-3-17 <i>Data Output</i> on page 2-248. None: The Sensor Controller outputs measurement results without synchronizing with external devices. Handshaking: The Sensor Controller outputs measurement results with synchronizing with external devices.

Setting item	Setting value [Factory default]	Description
Output period [ms]	2.0 to 5,000.0 [10.0]	<p>Valid only when <i>Output control</i> is set to <i>None</i>. Set the cycle by which measurement results are output.</p> <ul style="list-style-type: none"> Set the period so that the interval is longer than the <i>Output time</i>, but less than the measurement interval. Adjust this value based on the RPI (packet interval) communication cycle in the EtherNet/IP connection settings for the external device such as a PLC to be connected. <p>For details, refer to <i>EtherNet/IP Communication Cycle (RPI)</i> on page 2-194.</p>
Output time [ms]	1.0 to 1,000.0 [5.0]	<p>Valid only when <i>Output control</i> is set to <i>None</i>. Set the cycle by which measurement results are output. Set the ON time for the GATE signal. Set the time required for an external device to get measurement results. Adjust this value based on the RPI (packet interval) communication cycle in the EtherNet/IP connection settings for the external device such as a PLC to be connected.</p> <p>For details, refer to <i>EtherNet/IP Communication Cycle (RPI)</i> on page 2-194.</p>
Timeout [s]	0.5 to 120.0 [10.0]	<p>Valid only when <i>Output control</i> is set to <i>Handshaking</i>. A timeout error occurs when no response from external devices is received at the following timing within the time that has been set. In the following cases, a timeout error occurs when the state of each signal does not change within the time that has been set.</p> <ul style="list-style-type: none"> If the DSA signal were not turned ON even after a certain time passed from when measurement has been completed. The DSA signal turns OFF after the GATE flag has turned ON. The DSA signal turns ON after the GATE flag has turned OFF.

Setting item	Setting value [Factory default]	Description
Output data size	Result Data Format 0 (32 bytes) Result Data Format 1 (64 bytes) Result Data Format 2 (128 bytes) Result Data Format 3 (256 bytes)	Set the data size to output as measurement results for each line. The settings are reflected at the restart after they were stored. There are four types in the output data size: 32, 64, 128, and 256 bytes. Result Data Format 0 (32 bytes) Out put data 0 to 7 of 4 bytes can be used and total size of the output data is 32 bytes. Result Data Format 1 (64 bytes) Out put data 0 to 15 of 4 bytes can be used and total size of the output data is 64 bytes. Result Data Format 2 (128 bytes) Out put data 0 to 31 of 4 bytes can be used and total size of the output data is 128 bytes. Result Data Format 3 (256 bytes) Out put data 0 to 63 of 4 bytes can be used and total size of the output data is 256 bytes.
User area	<ul style="list-style-type: none"> • [None] • ON 	Set whether or not to use the User Area (user input and output areas) <ul style="list-style-type: none"> • Data type of User Input Area 0 to 3 is DINT. Data type of User Input Area 4 to 5 is LREAL. • Data type of User Output Area 0 to 3 is DINT. Data type of User Output Area 4 to 5 is LREAL.



Precautions for Correct Use

About Output data size and User Area

All line's Output data size and User Area are necessary to be equal when you select the Multi-line random trigger in Operation mode.

4

- Click **Apply** to apply the settings.
- Click **Close** to close the System Settings dialog box.



Precautions for Correct Use

PLC Connection Timeout Interval

Set the *PLC connection timeout interval* so that it is longer than the *measurement processing time*. For the timeout value, refer to 2-3-3 *EtherNet/IP Communications* on page 2-196.

2-3-8 Setting Tag Data Link

This section describes how to set data links for EtherNet/IP.

The communication areas in the external device such as an external device such as a PLC to data-link with the Sensor Controller are specified as tags (tag sets), and the connections are set for tag data link communications.

When you connect to an OMRON Controller to communicate with it via EtherNet/IP, use the Network Configurator to perform the tag data link settings such as tag, tag set, and connection setting.

Here, describes how to set tag data links using the Network Configurator.

For details of the tag data link settings using Network Configurator, refer to the following manuals.

- *NJ-series CPU Unit Built-in EtherNet/IP Port User's Manual (Cat. No. W506)*
- *CS/CJ series EtherNet/IP Units Operation Manual (Cat. No. W465)*
- *CJ series EtherNet/IP Units Operation Manual for NJ-series CPU Unit (Cat. No. W495)*



Precautions for Correct Use

- When connecting to a CPU Unit of NJ series or CJ series, install the EDS file that defines the connection information for the Sensor Controller to the Support Software (e.g., Network Configurator). Download the EDS file from our OMRON's website.
- After the tag data link was set, the Vision Sensor is automatically restarted to apply the settings.

Settings Tags, Tag Sets, and Connection

Here, set each communication area in the external device such as a PLC as tag data link connections as shown in the following table.

● Tag and Tag Set Settings in the External Device such as a PLC

Setting item	Description	
	Command Area	Response Area and Output Area
Type of tags and tag sets	Output tag set	Input tag set
Name of tags and tag sets	I/O memory addresses or variable names	I/O memory addresses or variable names* ¹

Setting item	Description	
	Command Area	Response Area and Output Area
Data size	<p>The size will be the sum of the size of the Command Area and the User Input Area.</p> <ul style="list-style-type: none"> • 20 bytes (When the User Area is not used.) • 52 bytes (When the User Area is used.) 	<p>The size will be the sum of the size of the Response Area, Data Output Area, and User Output Area.</p> <p>Result Data Format 0 is selected:</p> <ul style="list-style-type: none"> • 48 bytes (When the User Area is not used.) • 80 bytes (When the User Area is used.) <p>Result Data Format 1 is selected:</p> <ul style="list-style-type: none"> • 80 bytes (When the User Area is not used.) • 112 bytes (When the User Area is used.) <p>Result Data Format 2 is selected:</p> <ul style="list-style-type: none"> • 144 bytes (When the User Area is not used.) • 176 bytes (When the User Area is used.) <p>Result Data Format 3 is selected:</p> <ul style="list-style-type: none"> • 272 bytes (When the User Area is not used.) • 304 bytes (When the User Area is used.)

*1. Specify the top of the I/O memory address in the Response Area.
 The Output Area is allocated continuously following the Response Area.
 When a variable name is used for it, the specified variable is allocated as including both the Response Area and Output Area.
 For information about how to access each signal in the communication area assigned to the variable from the user program, refer to *Accessing Communication Areas Using Variables by NJ Series Controllers* on page 2-230.

● **Settings the Sensor Controller (Device parameters Settings)**

- 1** Right-click the Sensor Controller on the network in the Network Configurator and select **Parameter** → **Edit**.
- 2** As the Edit Device Parameter dialog box will open, perform the settings as necessary.

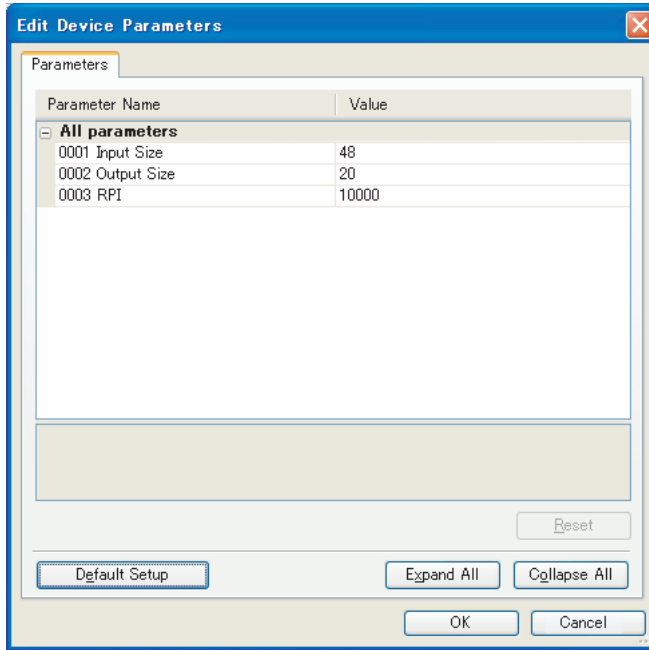

Parameter name	Description	Setting value
0001 Input Size ^{*1}	The size will be the sum of the size of the Response Area, Data Output Area, and User Output Area.	Set one of the following values. Result Data Format 0 is selected: <ul style="list-style-type: none"> • 48 bytes (When the User Area is not used.) • 80 bytes (When the User Area is used.) Result Data Format 1 is selected: <ul style="list-style-type: none"> • 80 bytes (When the User Area is not used.) • 112 bytes (When the User Area is used.) Result Data Format 2 is selected: <ul style="list-style-type: none"> • 144 bytes (When the User Area is not used.) • 176 bytes (When the User Area is used.) Result Data Format 3 is selected: <ul style="list-style-type: none"> • 272 bytes (When the User Area is not used.) • 304 bytes (When the User Area is used.)
0002 Output Size ^{*2}	The size will be the sum of the size of the Command Area and the User Input Area.	Set one of the following values. <ul style="list-style-type: none"> • 20 bytes (When the User Area is not used.) • 52 bytes (When the User Area is used.)
0003 RPI ^{*3}	The required packet interval	10,000

*1. Although the data size can be set up to 502 bytes, use the above setting.

*2. Although the data size can be set up to 502 bytes, use the above setting.

*3. The packet interval (RPI) is set in the connection settings between the external device such as a PLC and the Sensor Controller. No additional setting is required here.

● Connection Settings

Setting item		Description
Originator device (PLC)	Input tag set	External device such as a PLC_tag_set_name - [48 bytes]* ¹
	Connection type	Any (default: Point to Point connection)
	Output tag set	External device such as a PLC_tag_set_name - [20 bytes]* ¹
Target device (Sensor Controller)	Output tag set	Input_101 - [48 Bytes]* ¹
	Input tag set	Output_100 - [20 Bytes]* ¹
Packet interval (RPI)		Any (default: 50.0)* ²
Timeout value		Any (default: Packet interval (RPI) x 4) Set this value so that it is longer than the measurement processing time of the Sensor Controller.

*1. Tags and tag sets in the external device such as a PLC need to be the same.

*2. Adjust the value based on the communication settings of the Sensor Controller such as the output period and output time.

For details, refer to *EtherNet/IP Communication Cycle (RPI)* on page 2-194.



Precautions for Correct Use

- If the CIO memory area that holds contents were not specified when I/O memory addresses are specified for communication areas, the information in each communication area will be cleared when the operating mode of the external device such as a PLC is changed.
- The settings for the following Assembly Object are required to specify instances without using the EDS file.

Assembly Object Settings:

Setting item	Setting value	Description	Size
Instance	100	Output connection (for normal control and for line 0 in Multi-line Random-trigger Mode)	The sum of the size of the Command Area and the User Input Area. *1
	101	Input connection (for normal control and for line 0 in Multi-line Random-trigger Mode)	The sum of the size of the Response Area, Data Output Area, and User Output Area. *2
	102	Output connection (for line 1 in Multi-line Random-trigger Mode)	The sum of the size of the Command Area and the User Input Area. *1
	103	Input connection (for line 1 in Multi-line Random-trigger Mode)	The sum of the size of the Response Area, Data Output Area, and User Output Area. *2
	104	Output connection (for line 2 in Multi-line Random-trigger Mode)	The sum of the size of the Command Area and the User Input Area. *1

Setting item	Setting value	Description	Size
	105	Input connection (for line 2 in Multi-line Random-trigger Mode)	The sum of the size of the Response Area, Data Output Area, and User Output Area. *2
	106	Output connection (for line 3 in Multi-line Random-trigger Mode)	The sum of the size of the Command Area and the User Input Area. *1
	107	Input connection (for line 3 in Multi-line Random-trigger Mode)	The sum of the size of the Response Area, Data Output Area, and User Output Area. *2
	108	Output connection (for line 4 in Multi-line Random-trigger Mode)	The sum of the size of the Command Area and the User Input Area. *1
	109	Input connection (for line 4 in Multi-line Random-trigger Mode)	The sum of the size of the Response Area, Data Output Area, and User Output Area. *2
	110	Output connection (for line 5 in Multi-line Random-trigger Mode)	The sum of the size of the Command Area and the User Input Area. *1
	111	Input connection for line 5)	The sum of the size of the Response Area, Data Output Area, and User Output Area. *2
	112	Output connection for line 6 in Multi-line Random-trigger Mode)	The sum of the size of the Command Area and the User Input Area. *1
	113	Input connection for line 6 in Multi-line Random-trigger Mode)	The sum of the size of the Response Area, Data Output Area, and User Output Area. *2
	114	Output connection for line 7 in Multi-line Random-trigger Mode)	The sum of the size of the Command Area and the User Input Area. *1
	115	Input connection (for line 7 in Multi-line Random-trigger Mode)	The sum of the size of the Response Area, Data Output Area, and User Output Area. *2

*1. 20 bytes (When the User Area is not used.)

52 bytes (When the User Area is used.)

*2. Result Data Format 0 is selected:

48 bytes (When the User Area is not used.)

80 bytes (When the User Area is used.)

Result Data Format 1 is selected:

80 bytes (When the User Area is not used.)

112 bytes (When the User Area is used.)

Result Data Format 2 is selected:

144 bytes (When the User Area is not used.)

176 bytes (When the User Area is used.)
 Result Data Format 3 is selected:
 272 bytes (When the User Area is not used.)
 304 bytes (When the User Area is used.)

2-3-9 Output Data Settings (Processing Item Registration)

Here, set the output items and output format to be used with EtherNet/IP.

This processing item is not available in the FHV series. When you set output data in the FHV series, refer to *2-3-10 Setting Output Data (Numerical Values and Character Strings)* on page 2-217.

Registering Processing Items

Register the processing items for data output in the measurement flow.

- 1 Click **Edit flow** in the Toolbox Pane.
- 2 Select the **Fieldbus Data Output** processing item in the processing item tree.

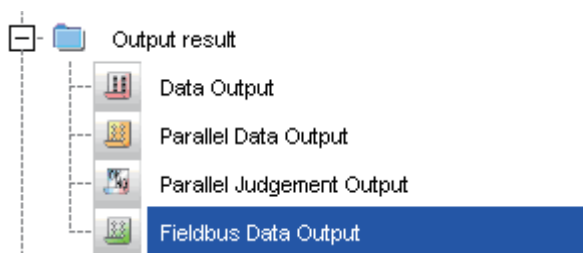

- 3 Click **Append**.
 The **Fieldbus Data Output** processing item is added at the bottom of the unit list (flow).

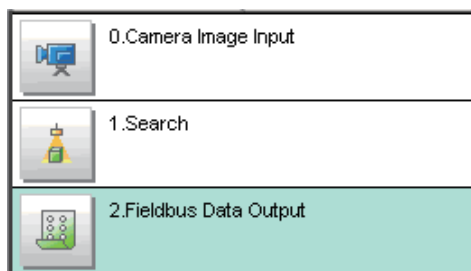

- 4 Click the **Fieldbus Data Output** icon and set the data output items and data format.
 For details of the settings, refer to the following.
Registering the Items to Output on page 2-214



Precautions for Correct Use

Fieldbus Data Output

Perform the communication settings before the settings of Fieldbus Data Output.

Note that if you changed the communication settings after the settings of Fieldbus Data Output, the changed settings will not be displayed on the Fieldbus Data Output setting display.



Additional Information

- The number of outputtable items for single data output processing item is 8 to 64 depending on data output settings in each line. If you need to output more data items, use more than one Output Unit.
However, the data is output to the same destination, so if you do not control the output, the data that was output first will be overwritten by the followed data.
Use the following method to read each set of output data.

Controlling Data Output with Handshaking

When the output control uses handshaking, the output timing of the data can be controlled by I/O signals.
Each time the data is output, read the output data and move it to a different part of the I/O memory in the external device such as a PLC.
For details of handshaking, refer to *Data Output Control with Handshaking* on page 1-24.

- Data is output in the order that processing items for output are registered in the measurement flow, i.e., the timing is different for each data output processing item. (Data output is executed in the order that it is executed in the measurement flow.)
For details, refer to *Outputting the Measurement Data* on page 1-18.

Registering the Items to Output

Set the output data with expressions.

- Click the Fieldbus Data Output  icon in the measurement unit list (flow).
- In the Item tab area, click **Setting**.
- In the list, click the output data number to set the expression.

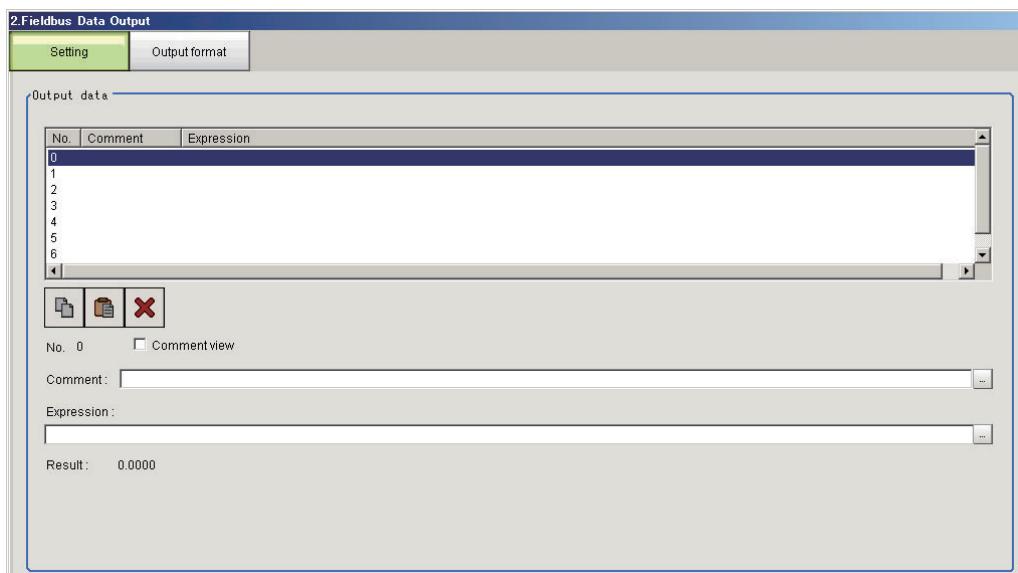

The selected output data number is displayed under the list.

- Click  next to the expression text box and set the expression.



Specify the processing items, measurement results, and measurement data in the expression. Arithmetic or function calculations can be applied to the measurement data to output. For details of the calculation settings, refer to *Calculation* in the *Vision System FH/FHV Series Processing Items Reference Manual (Cat. No. Z341)*.

- 5 Click  for the **Comment** text box and enter the description for the expression. The entered comment will be displayed in the detailed results area on the Main window. For example, *Test* was entered as the comment for the expression 0, *Test* will be displayed instead of *Expression 0* in the detailed results areas on the Main window.
- 6 Repeat step 3 to 5 to set expressions for all of the required output data numbers.



Additional Information

If you delete one of the expressions that is set for output data 0 through 7, the output numbers for all expressions after the deleted expression will stay the same. However, the actual data output will be output as though the list has been shifted forward for the number of expressions that have been deleted.

To prevent data from being written to the wrong locations, use copy and paste to shift the expressions after the deleted number forward.

For details of the Data Output Area, refer to *2-3-12 Memory Allocation* on page 2-226.

Example: If the Expression for Output 1 Is Deleted

Output Item Settings

No.	Comment	Expression
0	Reference SX	U1.SX
1	Reference SY	U1.SY
2	Reference an...	U1.ST
3		
4		

Data Output Destination (Data Output Area)

First word	Bit	
	15	to 0
+8	DATA1 (Reference SX)	
+9		
+10	DATA2 (Reference SY)	
+11		
+12	DATA3 (Reference angle ST)	
+13		



Output 1 is deleted.

Output Item Settings

No.	Comment	Expression
0	Reference SX	U1.SX
1		
2	Reference an...	U1.ST
3		
4		

Data Output Destination (Data Output Area)

First word	Bit	
	15	to 0
+8	DATA1 (Reference SX)	
+9		
+10	DATA3 (Reference angle ST)	
+11		
+12		
+13		

The output numbers assigned to the expressions remain the same, but the data output location is shifted forward for data 3.

Output Format (Fieldbus Data Output)

- 1 Click the Fieldbus Data Output  icon in the measurement unit list (flow).
- 2 In the item tab area, click **Output format**.

3 Select the output format.

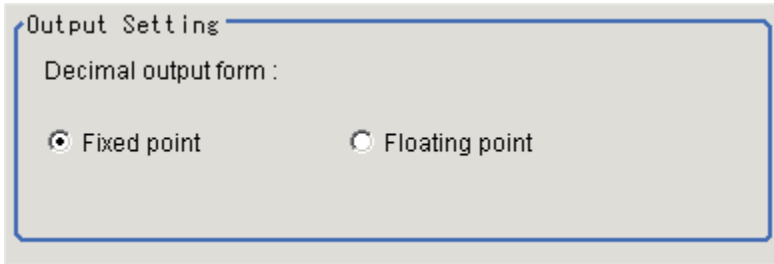

Setting item	Setting value [Factory default]	Description
Decimal output format	<ul style="list-style-type: none"> • [Fixed point] • Floating point 	<ul style="list-style-type: none"> • Fixed point Data is output multiplied by 1,000. ex.: For 123.456, it will be 0001E240 hex. • Floating point Data is output in floating point format. ex.: For -123.4567, it will be C2F6E979 hex.

2-3-10 Setting Output Data (Numerical Values and Character Strings)

Registering Processing Items

Register the processing items for data output in the measurement flow.

- 1 In the Main window, click **Edit flow** in the Toolbox Pane.
- 2 Click **Result output (I/O)** in the processing item tree.

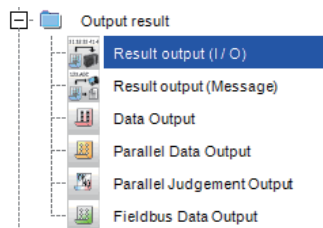

- 3 Click **Append**.
The **Result output (I/O)** processing item is added at the bottom of the unit list (flow).

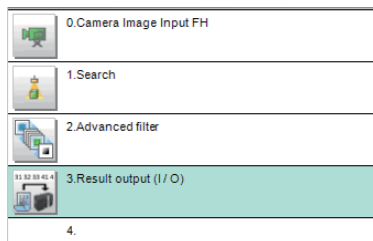

- 4 Click **Result output (I/O)**  icon in the unit list (flow) or **Set** to set the output device and the output data.

Setting the Output Device

Here, set a communication method when data is output.

- 1 Click **Result output (I/O)**  icon in the unit list (flow) or **Set** to set the output device and the output data.
The **Result output (I/O)** setting window is displayed.

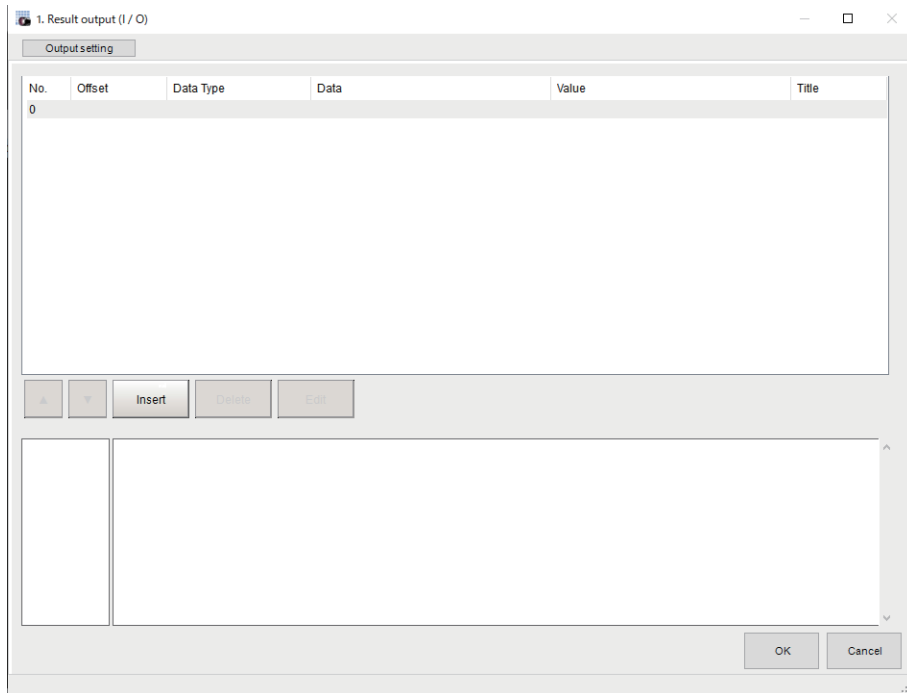

- 2 Click **Output setting**.
The **Output setting** window is displayed.

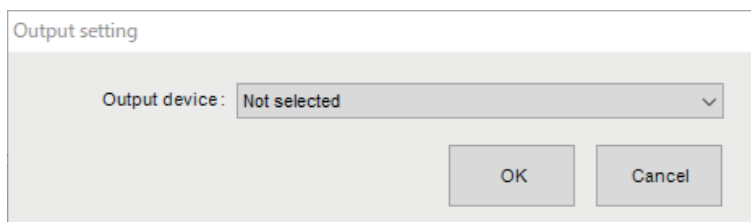

- 3 Click  at the right side of the **Output device**. Select *Fieldbus*.

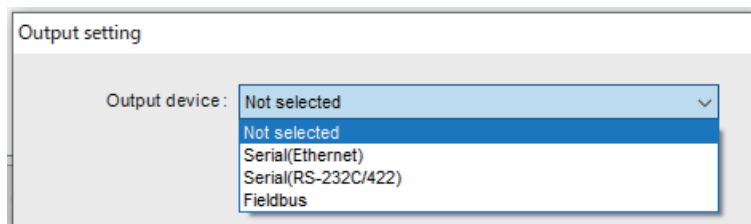



Precautions for Correct Use

- The displayed output device is determined based on the selection of **Communication module** in the **System settings** in the item tab.
- Executing measurements without an output device selected causes a failure (NG: No measurement) in the judgment of the processing unit.

Setting the Output Data

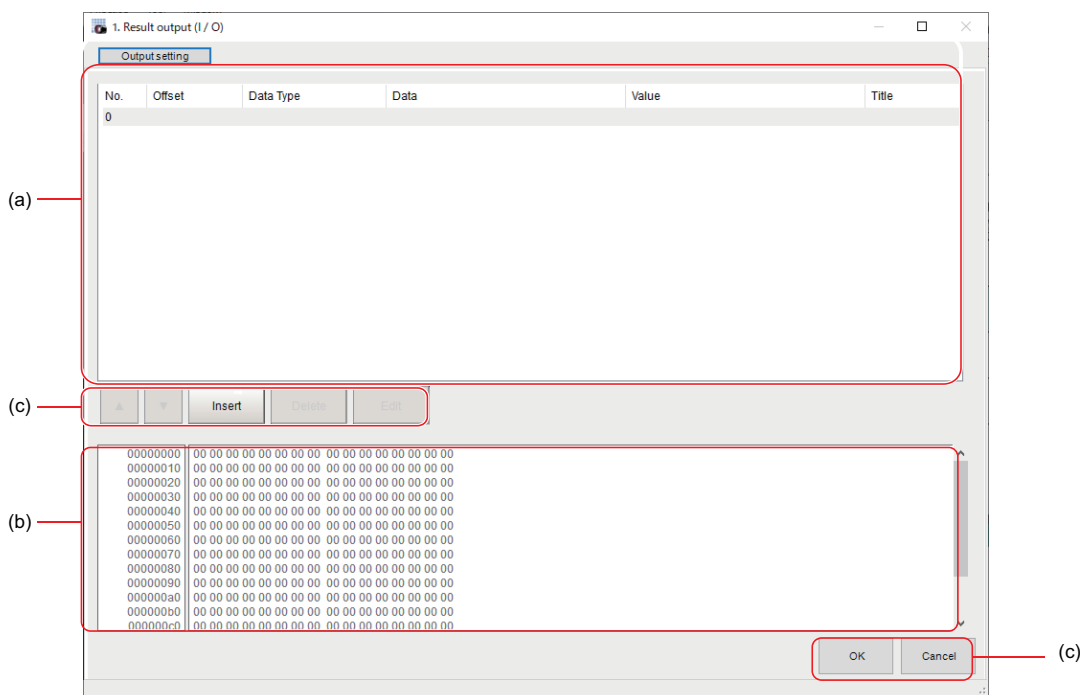

Here, set the data to output such as processing item data or fixed character strings.

- 1 In the item tab area, click **Output data**.
The **Result output (I/O)** setting window is displayed.



- a) Setting data display area
The No. (output number), Offset (indicating the byte position from the beginning), Data type (integer, double, string), Data, Value, and Title (data description) are displayed in this area. A value is displayed when a variable is assigned to data.
- b) Output data display area
Contents in the output data display area in binary (hex) are displayed in this area.
- c) Button

Button	Description
	Moves the selected data up one position.
	Moves the selected data down one position.
	Adds new data to the selected data position.
	Deletes the selected data. The following data moves up after the deletion.
	Edits the selected data.

Button	Description
	Saves the current settings and returns to the previous view.
	Discards the current settings and returns to the previous view.

- 2** In the list, select the output data number to set the output and then click **Insert**.
The following **Output data editing** dialog box is displayed.

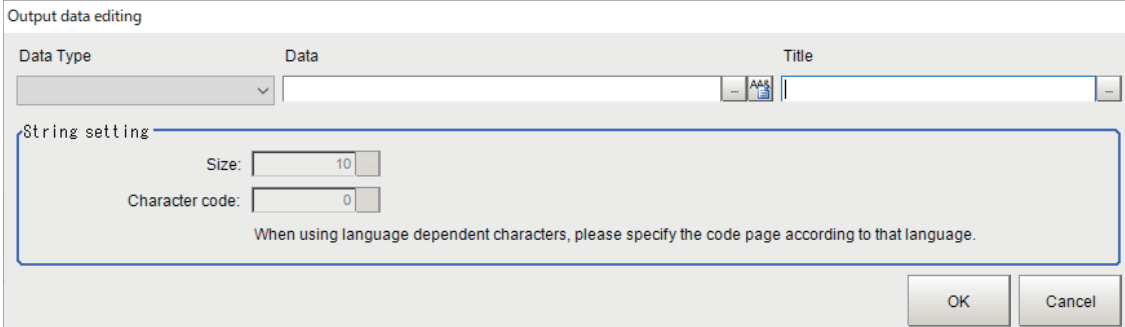

Setting item	Setting value [Factory default]	Description
Data type	<ul style="list-style-type: none"> Integer Double String 	Sets the data type.
Data	—	There are two input methods.*1 <ul style="list-style-type: none"> Enter strings directly Assign variables
Title	—	Enters the description for data.
String settings		Valid when <i>String</i> is selected in the “Data type”.
Size	0 to 4,095 [10]	Sets the number of characters. The number of characters that can be output depends on the data size setting for the tag and tag-set settings in the PLC.
Character code	[0]	Sets the code page according to the language to be used.

*1. Any arithmetic expression cannot be used. If it is used, it will be handled as character strings.

- Character code: Specify the following code page for each language.

Language	Code page	Language	Code page	Language	Code page
Japanese	932	English	1252	Chinese (simplified)	936
German	1252	French	1252	Chinese (traditional)	950
Italian	1252	Spanish	1252	Korean	949
Vietnamese	1258	Polish	1250		

- The default 0 is no language-dependent letters in ANSI code page.
- If non-existing code page is selected, corresponding data is handled as invalid data (NULL).

- 3** Click  at the right side of the **Data type** text box to select the data to output. *Integer*, *Double*, or *String* are selectable.

Data type	Description
Integer	<ul style="list-style-type: none"> Entered data is handled as four-byte data. Allowable entering range is a range of signed INT. When string variables are specified for data, character strings like digits which can be converted into numerical values will be converted and output. When decimal digits are included, they are truncated. Moreover, they are handled as "0" if they are not convertible.
Double	<ul style="list-style-type: none"> Entered data is handled as eight-byte data. The allowable entering range is a range of eight-byte floating decimal value. When string variables are specified for data, character strings like digits which can be converted into numerical values will be converted and output. Moreover, they are handled as "0" if they are not convertible.
String	<ul style="list-style-type: none"> Entered data is set based on specified <i>Size</i>. Example: Size is four and the entered data is ABCD. ABCD → ABC+NULL The number of allowable entering characters is up to 4,095. If this limit is exceeded, nothing is displayed and output. When NULL is included in the entered character string, the character string following NULL is not output. The following escape sequence codes can be entered. The entered escape sequence codes are handled as fixed character strings. \N: Carriage return, \r: Line feed, \t: Tab, \XXX: ASCII code specified by "XX" (numerical value), \": Double quotation mark, \: Backslash

4 Enter data into *Data* text box.

Data that can be output with one data No. is a range only to be handled as one string.

1) When directly entering an output content into the **Data** text box.

A string enclosed with " " (double quotation marks) handled as one string and the rest following it is not output.

Example: "AA"TEST → only "AA" is output.

2) In the case where assignment variable is assigned o data:

Directly enter a variable name (Scene variable: SC.~) or specify a variable in *Variable*

assignment window displayed by clicking .

- Only one variable is valid for one data No.

Example: SC.A\$+SC.B\$ → Only SC.A\$ is output.

- When a fixed string, e.g. AA, is entered before a variable, the subsequent variable is also handled as a fixed string.

Example: AA+SC.AA& → "AA+SC.AA&"

- When "String" is selected in the "Data type" but "Integer" or "Double" is set to the variable, then the variable is converted to a string and then output.

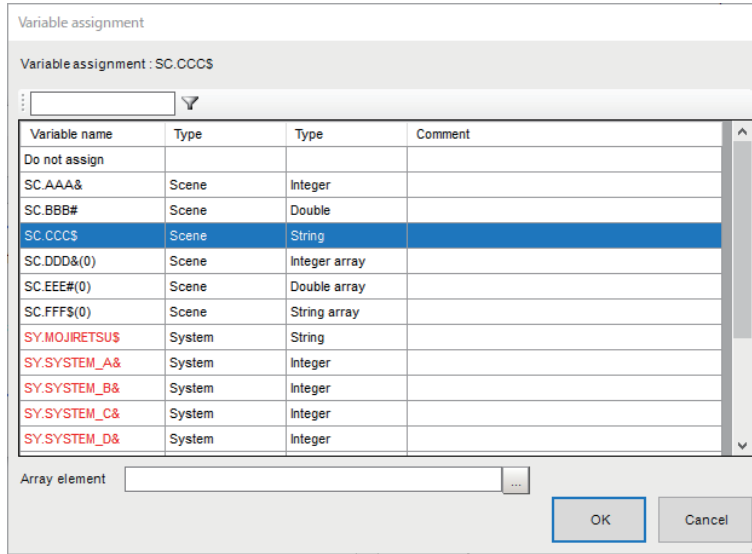

5 Enter *Title* that indicates the content of output data.

6 When *String* is selected in *Data type*, the following items in *String setting* area also needs to be set.

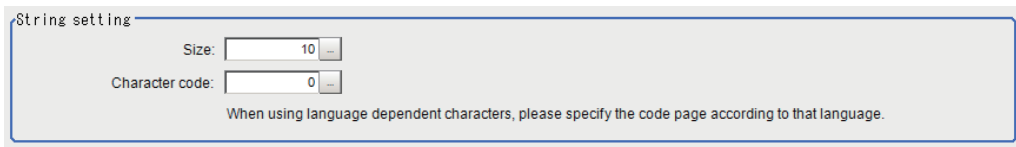

Example:

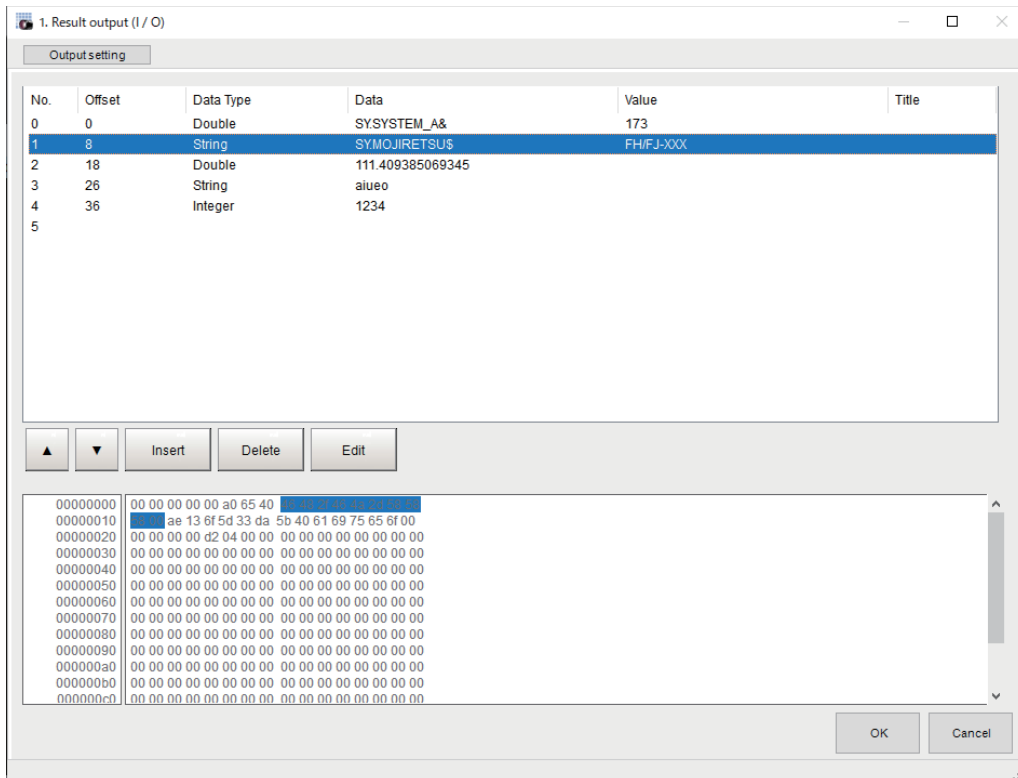

7 Click **OK** in the end of entering data to close the settings.

2-3-11 Testing Communications

Here, check whether or not the EtherNet/IP communication settings are correct.

For the communication settings, refer to 2-3-7 *Communication Specifications Settings* on page 2-201.

If communications cannot be established after the setup, use the following procedures to check the setting details and the communication status.

Before Testing Communications

Here, *Serial (Ethernet) - Normal (UDP)* communication module is used as an example to describe the procedures.

When checking the communication settings, stop the program on the external device such as a PLC.

Checking Communication Settings

Use the following procedures to check whether or not the communication settings are correct.

1. On the Main Window, select [Tool] – [System Settings]. In the tree view on the left, select [System Settings] – [Communication] – [Ethernet Normal (xyz)]. (“xyz” depends on the Communications Module.)
2. Set the IP address of the Sensor Controller. The default settings are as follows:
Address setting: 10.5.5.100
Address setting 2: 10.5.6.100

3. On the Main Window, select [Tool] – [System Settings]. Select [System Settings] – [Communication] – [EtherNet/IP] from the tree view on the left.

4. Click the [Settings] tab.
5. Set the output control. Set whether to provide an interlock with the external device such as a PLC when performing data output.

*** Output Period**

Set the cycle by which measurement results are output.

Set the value so that the interval is longer than the output time and shorter than measurement interval.

Output time

Set the interval during which the GATE signal (the signal that tells the external device such as a PLC when to read the measurement results) is ON.

This interval must be longer than the cycle time of the external device such as a PLC and the EtherNet/IP packet interval (RPI). Set these values so that they satisfy the following relationships:

$$RPI < \text{Output time}$$

$$\text{GATE ON time} = \text{Output time}$$

$$\text{GATE OFF time} = \text{Output period} - \text{Output time}$$

(The output period and output time are only valid when output control is set to [None].)

6. This completes the Controller settings. The external device such as a PLC settings are set next.

Checking the Communication Status

Use the ping command to check whether or not the Sensor Controller exists on the Ethernet network. With it, check that the Sensor Controller IP address has been correctly set and is correctly connected to the Ethernet network.



Additional Information

The ping command uses the ICMP protocol to send a response request to a device connected through an Ethernet network and determines the time required to respond to that request. If you properly receive a response from the destination device, the network connection and network settings are correctly set.

- 1 Connect the Sensor Controller and a computer with an Ethernet cable. Set the high-order digits of the computer IP address to the same values as the Sensor Controller and the low-order one digit to a different value.

<IP Address Setting Example>

Device	Example
Sensor Controller	10.5.5.100 (default)
Computer	10.5.5.101

- 2** Open the Windows command prompt on the computer and perform the ping command. At the > prompt, type *ping*, followed by a space and the Sensor Controller IP address, and then press *Enter*.

Example:

```
C:\>ping 10.5.5.100
```

- 3** After a few seconds, *Reply from* followed by the IP address of the Sensor Controller (e.g., 10.5.5.100) are displayed, it means that the Sensor Controller is connected to the Ethernet network properly.

Example:

```
Reply from 10.5.5.100: byte=32
```

```
Time<1 ms TTL=128
```

If anything other than *Reply from* is displayed:

The Sensor Controller is not connected to the Ethernet network for some reason. Check the following.

- Are the high-order three digits of the IP addresses for the computer and the Sensor Controller the same?
- Is the Ethernet cable correctly connected?

- 4** Use the ping command to check the communication status of the external device such as a PLC as well.

After you have confirmed the communication status as described above, transmit a measurement command to the Sensor Controller in practice to check the communication operations as the Vision Sensor.

2-3-12 Memory Allocation

This section describes the assignments of the Command Area for the input connection to the Sensor Controller and the Response Area and Output Area for the output connection to the external device such as a PLC.

Input Connection to the Sensor Controller (External Device such as a PLC (Originator) to Sensor Controller (Target))

For the input connections to the Sensor Controller, specifies the control inputs, command codes, command parameters, and User Input Area, which are the Command Area parameters.

● Command Area

Set the first channel in Command Area.	Bit																Name
	15	14	13	12	11	10	9	8	7	6	5	4	3	2	1	0	
+0	E R C L R							X E X E							S T E P	E X E	Control input (2 CH)
+1																D S A	
+2	CMD-CODE																Command Code (2 CH)
+3																	
+4	CMD-PARAM																Command parameters (Max. 6 CH)
+5																	
+6																	
+7																	
+8																	
+9																	
+10	User Input Area 0																User Input Area 0
+11																	
+12	User Input Area 1																User Input Area 1
+13																	
+14	User Input Area 2																User Input Area 2
+15																	
+16	User Input Area 3																User Input Area 3
+17																	
+18	User Input Area 4																User Input Area 4
+19																	
+20																	
+21																	

Set the first channel in Command Area.	Bit																Name
	15	14	13	12	11	10	9	8	7	6	5	4	3	2	1	0	
+22	User Input Area 5																User Input Area 5
+23																	
+24																	
+25																	

Signal	Signal name	Function
EXE	Command Execution Bit	Performs a command. For details, refer to 2-3-15 <i>Command List</i> on page 2-240.
DSA	Data Output Request Bit	Requests the next data output. For details, refer to 2-3-9 <i>Output Data Settings (Processing Item Registration)</i> on page 2-213.
STEP	Measure Bit	Performs measurement one time.
XEXE	Flow Command Request Bit	Instructs a command execution during the execution of the Fieldbus flow control.
ERCLR	Error Clear Bit	Clears the error signal (ERR bit). The ERROR signal of the parallel interface and the ERR LED of the indicator light are not cleared.
CMD-CODE	Command Code	Stores the command code.
CMD-PARAM	Command parameters	Stores the command parameters.
User Input Area 0 to 5	User Input Area 0 5	This area is used that you write the data that you defined for the Sensor Controller. <ul style="list-style-type: none"> Data type of User Input Area 0 to 3 is DINT. Data type of User Input Area 4 to 5 is LREAL.

Output Connection to External Device such as a PLC (Sensor Controller (Originator) to External Device such as a PLC (Target))

For output connections to the external device such as a PLC, execution results and output data from the Sensor Controller are set. The execution results such as control outputs, command codes, response codes, and response data are output to the Response Area, and the output data from the Sensor Controller or the User Output Area is output to the Data Output Area.



Additional Information

The order in which data is stored depends on the manufacturer of the connected external device such as an external device such as a PLC.
 For details, refer to A-1-1 *Parameter Notation Examples for Command Control* on page A-2.

● Response Area

First channel in Response Area	Bit															Name						
	15	14	13	12	11	10	9	8	7	6	5	4	3	2	1		0					
+0	E	R	R				X	X	X							A	R	O		B	F	Control output (2 CH)
+1							W	B	F							C	U			U	L	
+2	CMD-CODE															Command Code (2 CH)						
+3																						
+4	RES-CODE															Response Code (2CH)						
+5																						
+6	RES-DATA															Response Data (2 CH)						
+7																						

● Data Output Area

When the User Area is used, data set as the number of output data in the EtherNet/IP output specifications are output followed by the data of the User Output Area. Therefore, the first channel of the User Output Area will be changed according to the number of output data.

The following table indicates the mapping of the Data Output Area and User Output Area when Result Data Format 0 (32 bytes) is selected as the number of the output data.

First channel in Data Output Area	Bit															Name
	15	14	13	12	11	10	9	8	7	6	5	4	3	2	1	
+8	DATA0															Output data 0
+9																
+10	DATA1															Output data 1
+11																
+12	DATA2															Output data 2
+13																
+14	DATA3															Output data 3
+15																
+16	DATA4															Output data 4
+17																
+18	DATA5															Output data 5
+19																
+20	DATA6															Output data 6
+21																

First channel in Data Output Area	Bit															Name
	15	14	13	12	11	10	9	8	7	6	5	4	3	2	1	
+22	DATA7															Output data 7
+23																
+24	User Output Area 0															User Output Area 0
+25																
+26	User Output Area 1															User Output Area 1
+27																
+28	User Output Area 2															User Output Area 2
+29																
+30	User Output Area 3															User Output Area 3
+31																
+32	User Output Area 4															User Output Area 4
+33																
+34																
+35	User Output Area 5															User Output Area 5
+36																
+37																
+38																
+39																

Signal	Signal name	Function
FLG	Command Completion Bit	Turns ON when command execution is completed.
GATE	Data Output Completion Bit	Turns ON when data output is completed.
BUSY	Command Busy Bit	Turns ON when command execution is in progress and turns OFF automatically when the execution was competed.
OR	Overall judgment	Turns ON when the overall judgment is NG. (The OR signal is output only when the <i>Output</i> option is selected in the Adjustment window.)
XFLG	Flow Command Completion Bit	Turns ON when execution of an entered command during the execution for the Fieldbus flow control is completed, i.e. XBUSY: ON to OFF).
XBUSY	Flow Command Busy Bit	Turns ON when an entered command is in execution during the execution of the Fieldbus flow control.
XWAIT	Flow Command Wait Bit	Turns ON when a command can be entered during the execution of the Fieldbus flow control.
RUN	Run Mode	Turns ON when the Sensor Controller is in Run Mode.
ACK	Command Reception bit	Turns ON when Measurement Bit (STEP) or Command Execution Bit is turned ON. Turns OFF after the command execution was completed and either the STEP Bit or EXE Bit is OFF.
ERR	Error Signal	Turns ON when the Sensor Controller detects an error signal. In Multi-line Random-trigger mode, an error for each line is output to the ERR bit of each line. In the case of a system error such as a fan error, it is output to the ERR bit on line 0.
CMD-CODE	Command Code	Returns the executed command code.
RES-CODE	Response Code	Stores the response data for the executed command.

Signal	Signal name	Function
RES-DATA	Response Data	Stores the response data for the executed command.
DATA0 to 7	Output data 0 to 7	Outputs the data set in the output processing item. When more than one processing item exists, data is overwritten on this area by performing handshaking.
User Output Area 0 to 5	User Output Area 0 to 5	This area is used that the Sensor Controller writes the data that you defined using Macro customize functions. • Data type of the User Output Area 0 to 3 is DINT. Data type of the User Output Area 4 to 5 is LREAL.

Accessing Communication Areas Using Variables by NJ Series Controllers

In Controllers of the NJ series, I/O memory addresses assigned to each communication area can be accessed from the user program only via variables.

Follow the procedures below.

● Accessing with Network Variables

Customize and define variables based on the structure of each communication area of the Sensor Controller. Use Sysmac Studio to define the variables.

For operations of Sysmac Studio, refer to *Sysmac Studio Version1 Operation manual (Cat. No. W504)*.

1 Define the data types for the variables.

Define the data types for the variables based on the structure of each communication area of the Sensor Controller.

1) Definition of data type to access a signal

First, define the data type for a BOOL array to access the control signals and status signals.

Here, define the data type called *U_EIPFlag*.

Name of data type: U_EIPFlag

Kind of derived data type: Union

Name of data type	Data type	
U_EIPFlag	UNION	
F	ARRAY[0..31]OF BOOLSpecifies an array of BOOL data from 0 to 31.
W	DWORD32-bit bit string data

2) Definition of data type for each communication area access

Define data types to access each communication area for the Command Area and Response and Output Areas respectively.

Here, define two kinds of data type: *S_EIPOutput* and *S_EIPInput*.

3) • Data type to access the Command Area

Name of data type: S_EIPOutput

Kind of derived data type: Structure

Name of data type	Data type	
S_EIPOutput	STRUCT	
ControlFlag	U_EIPFlagThe data type that was defined above (1)
CommandCode	DWORD32-bit bit string data
CommandParam1	DINT32-bit integer data
CommandParam2	DINT32-bit integer data
CommandParam3	DINT32-bit integer data

- Assignment example for the variable data type according to the Command Area.
For details, refer to *Input Connection to the Sensor Controller (External Device such as a PLC (Originator) to Sensor Controller (Target))* on page 2-226.

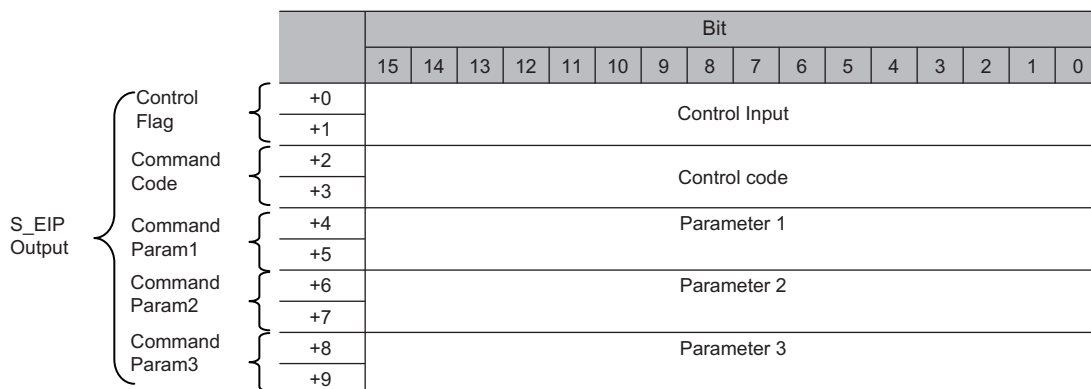

- Data type to access the Response and Output Areas
Name of data type: S_EIPInput
Kind of derived data type: Structure

Name of data type	Data type	
S_EIPInput	STRUCT	
StatusFlag	U_EIPFlagThe data type that was defined above (1)
CommandCodeEcho	DWORD32-bit bit string data
ResponseCode	DWORD32-bit bit string data
ResponseData	DINT32-bit integer data
OutputData	ARRAY[0..7]OF DINTSpecifies an array of DINT data from 0 to 7.

- Assignment example for the variable data type according to the Response and Output Areas.
For details, refer to *Output Connection to External Device such as a PLC (Sensor Controller (Originator) to External Device such as a PLC (Target))* on page 2-227.

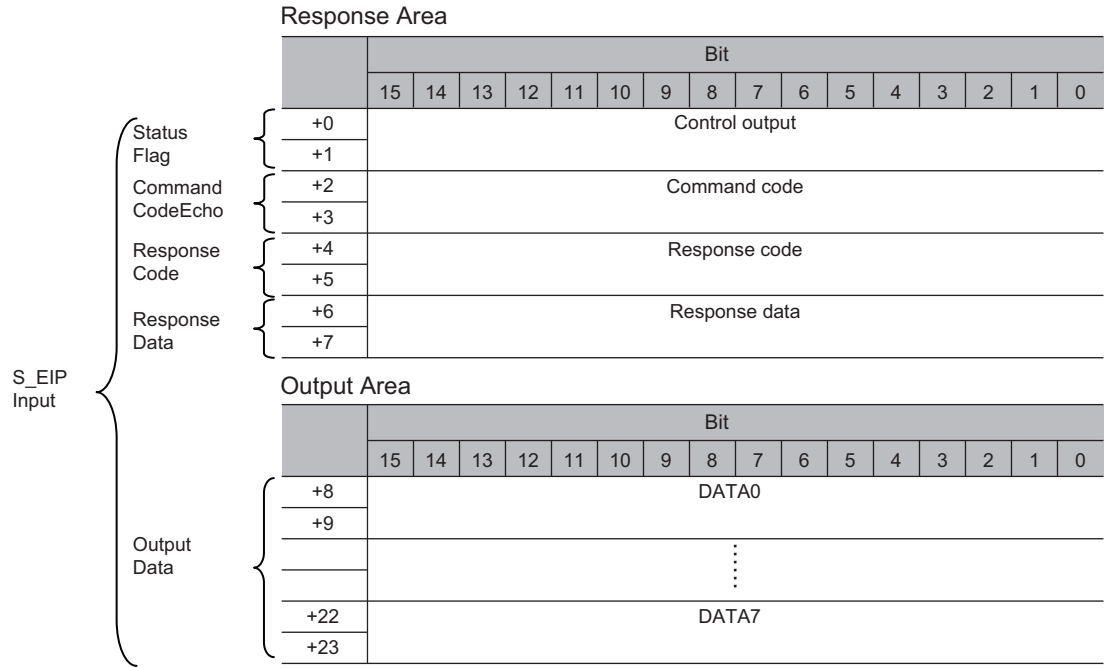

2 Define variables

Define variables to perform data links for data in each communication area through EtherNet/IP communications.

For these variables, the data types defined in step 1 are used.

Variable	Variable type	Network publish attribute	Data type	Application
EIPOutput	Global variable	Output	S_EIPOutput	For data links for the Command Area
EIPInput	Global variable	Input	S_EIPInput	For data links for the Response and Output Areas

3 Export the variables defined by Sysmac Studio.

Export the defined variables to use on the Network Configurator.

An CSV file is created for exporting.

4 Set Network Configurator

- 1) Import the CSV file, which was exported by Sysmac Studio, to Network Configurator. The imported variables are automatically registered as tags.
- 2) Configure the connections as shown below.

Originator device (External device such as a PLC) settings	Target device (Sensor Controller) settings
Input tag set: EIPOutput	Output tag set: Input101
Output tag set: EIPInput	Input tag set: Output100

5 Access each communication area from user program

The defined variables are used to access each communication area of the Sensor Controller as shown below.

- Command Area

Signal name	Variable name
EXE	EIPOutput.ControlFlag.F[0]
STEP	EIPOutput.ControlFlag.F[1]
XEXE	EIPOutput.ControlFlag.F[8]
ERCLR	EIPOutput.ControlFlag.F[15]
DSA	EIPOutput.ControlFlag.F[16]
Command Code	EIPOutput.CommandCode
Command parameter 1	EIPOutput.CommandParam1
Command parameter 2	EIPOutput.CommandParam2
Command parameter 3	EIPOutput.CommandParam3

- Response Area

Signal name	Variable name
FLG	EIPInput.StatusFlag.F[0]
BUSY	EIPInput.StatusFlag.F[1]
OR	EIPInput.StatusFlag.F[3]
RUN	EIPInput.StatusFlag.F[4]
ACK	EIPInput.StatusFlag.F[5]
XFLG	EIPInput.StatusFlag.F[8]
XBUSY	EIPInput.StatusFlag.F[9]
XWAIT	EIPInput.StatusFlag.F[10]
ERR	EIPInput.StatusFlag.F[15]
GATE	EIPInput.StatusFlag.F[16]
Command Code	EIPInput.CommandCodeEcho
Response Code	EIPInput.ResposeCode
Response Data	EIPInput.ResposeData

- Output area

Signal name	Variable name
Output data 1	EIPInput.OutputData[0]
.	.
.	.
.	.
Output data 8	EIPInput.OutputData[7]

● Specify the I/O memory addresses to access each communication area

By setting AT specifications to variables, assigned destination to each communication area can be specified in the unit of the I/O memory address.

- 1 Setting the tag sets (by Network Configurator)

Directly specify the tag names in the PLC by using the I/O memory addresses that each communication area is assigned to. (The output tags are specified for the input connections to the Sensor Controller and the input tags are specified for the output connections to the PLC.)

Setting example

Tag kind	Assigned I/O memory address
Output tag	D0
Input tag	D100

2 Setting Variables (by Sysmac Studio)

Define variables with AT (assigned destination) specifications to the I/O memory addresses assigned to each communication area as shown below.

Setting example

Variable	AT specification
a	D0.0
b	D0.1
c	D0.15
d	D1.0

3 Setting Connections

Configure the connections as shown below.

Originator device (PLC) settings	Target device (Sensor Controller) settings
Input tag set: D0	Output tag set: Input101
Output tag set: D100	Input tag set: Output100

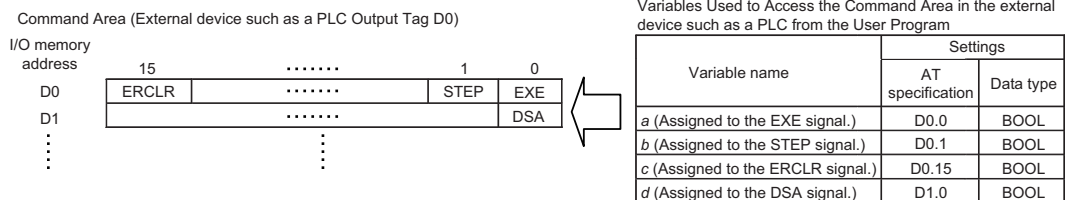

2-3-13 I/O Signals

The following tables list the signals used to control I/O for EtherNet/IP.

Input Signals

Signal	Signal name	Function	ON/OFF timing	
			OFF to ON	ON to OFF
EXE	Command Request Signal	The user (PLC) turns this signal ON when issuing a command to the Sensor Controller.	The user (PLC) turns this signal ON when issuing a command (instruct the execution) to the Sensor Controller based on the command code and command parameters.	The user (PLC) switches this signal from ON to OFF when the Sensor Controller turns the Command Completion (FLG) signal ON.*1
DSA (Used only for handshaking output control)	Data Output Request Signal	During handshaking, the user (PLC) issues this signal to the Sensor Controller to request to output externally the measured results performed in the measurement flow. When this signal is ON while an Output Unit (Fieldbus Data Output Unit) in the measurement flow is performed, the Sensor Controller outputs the data of the processing item.	<ul style="list-style-type: none"> The user (PLC) turns this signal ON when requesting the measurement data to output externally.*3 This DSA signal is turned ON at the same time as the Trigger (STEP) or Command Request (EXE) signal switches from OFF to ON. When more than one Output Units is used to output more than eight data, turn ON this DSA signal again after the GATE signal for the first data output turns OFF. For details, refer to <i>2-3-18 Timing Chart on page 2-250</i> .	The user (PLC) switches this signal from ON to OFF when the Sensor Controller turns the GATE signal ON.*2
ERCLR	Error Clear Bit	Clears the error signal (ERR bit). The ERROR signal of the parallel interface and the ERR LED of the indicator light are not cleared.	The user (PLC) switches the signal from OFF to ON when the Error (ERR) signal from the Sensor Controller is turned OFF.	This signal is turned OFF when the user (PLC) detected the Error (ERR) signal turned OFF.

Signal	Signal name	Function	ON/OFF timing	
			OFF to ON	ON to OFF
XEXE	Flow Command Request	This is turned on when a command will be performed while PLC Link, Fieldbus, or parallel flow control are performed.	The user (PLC) switches the signal from OFF to ON when it instructs an entered command execution during the execution of the Fieldbus flow control.	This signal switches from ON to OFF when the Flow Command Completion (XFLG) signal is turned ON.
STEP	Measurement Trigger	This is turned on when measurements will be performed.	This signal turns ON from the PLC) to perform measurement after confirming that the BUSY signal and the Command Execution Completion (FLG) signal have turned OFF.	The user (PLC) switches this signal from ON to OFF after detecting that the Sensor Controller turned the BUSY signal ON.

- *1. If the Command Request (EXE) signal does not switch from ON to OFF within 10 seconds after the Command Completion (FLG) signal was turned ON, a timeout error will occur, and the FLG signal is forced to be turned OFF.
- *2. If the Data Output Request (DSA) signal does not switch from OFF to ON within the time set at the “Time-out” in the settings after the Data Output Completion (GATE) signal turned ON, a timeout error will occur and the measurement data prepared for output will be discarded.
- *3. If the Data Output Request (DSA) signal does not switch from OFF to ON within the time set at the “Time-out” in the settings after the measurement processing started by the Measurement Trigger (STEP) signal or the Command Request (EXE) signal turned ON, a timeout error will occur and the measurement data prepared for output will be discarded.

Output Signals

Signal	Signal name	Function	ON/OFF timing	
			OFF to ON	ON to OFF
BUSY	Busy	This signal indicates that external inputs such as commands cannot be accepted. Issue a command when this signal is OFF. *1*2*3	This signal turns ON when the Sensor Controller receives a command from the user (PLC). (After the EXE signal switches from OFF to ON.)	The signal turns OFF when the command execution is completed.
FLG	Command Execution Completion	The Sensor Controller uses this signal to inform the PLC that command execution has been completed.	The signal turns ON when the Sensor Controller completes execution of a received command.	This signal is turned OFF when the user (PLC) switches the Command Request (EXE) signal from ON to OFF.

Signal	Signal name	Function	ON/OFF timing	
			OFF to ON	ON to OFF
GATE	Data Output Completion Signal	<p>The signal informs the PLC of the timing to load output data. "ON" of this signal indicates that the Sensor Controller is outputting the data.</p> <p>The user (PLC) starts to load the data when the signal turns ON.</p>	<ul style="list-style-type: none"> Without handshaking The signal turns ON when the Sensor Controller performs the Output Unit (Fieldbus Data Output Unit)^{*4} in the measurement flow and is ready for the data output. With handshaking The signal turns ON when the Sensor Controller performs the Output Unit (Fieldbus Data Output Unit)^{*4} in the measurement flow and is ready for the data output and the Data Output Request (DSA) signal is ON. 	<ul style="list-style-type: none"> Without handshaking The signal turns OFF after the <i>Output Time</i> set in the settings has passed. With handshaking This signal is turned OFF when the user (PLC) switches the Data Output Request (DSA) signal from ON to OFF.
ERR	Error Signal	<p>The signal indicates that the Sensor Controller detects the following errors.</p> <p>For details of the errors, refer to <i>Error Messages and Troubleshooting</i> in the Vision System FH/FHV Series User's Manual (Cat. No. Z365)..</p>	The signal turns ON if the Sensor Controller detects an error.	The signal turns OFF when the error is fixed and the user (PLC) turns the Error Clear (ERCLR) signal ON.
RUN	Run Mode	The signal indicates that the Sensor Controller is in RUN Mode.	The signal turns ON when the Sensor Controller is in Run Mode.	The signal turns OFF when the Sensor Controller is in Adjustment Mode.
OR	Overall judgment	The signal indicates the overall judgment results.	The signal turns ON when the overall judgment is NG.	The signal turns OFF when the overall judgment is OK.
ACK	Command Reception	The signal indicates that a command is received. Even BUSY is not output due to a heavy load, it surely detects the completion of the command processing execution.	The signal is turned ON when Measure Bit (STEP) or Command Execution Bit (EXE) is received.	The signal switches from ON to OFF after the execution completed and either the STEP Bit or EXE Bit is OFF.

Signal	Signal name	Function	ON/OFF timing	
			OFF to ON	ON to OFF
XFLG	Flow Command Execution Completion	The signal indicates that a command performed during execution of the Fieldbus flow control has been completed.	The signal is turned ON when a command performed has been completed (XBUSY switched from ON to OFF) during execution of Fieldbus flow control.	The signal is turned OFF when the Flow Command Request (XEXE) signal switches from ON to OFF during the execution for the Fieldbus flow control.
XBUSY	Flow Command Busy Bit	The signal indicates that a command entered during the execution of the Fieldbus flow control is in execution.	The signal switches from OFF to ON when a command entered during the execution for the Fieldbus flow control is in execution.	The signal switches from ON to OFF when a command execution entered during the execution of the Fieldbus flow control has been completed.
XWAIT	Flow Command Wait Bit	The signal indicates that a command entered can be accepted during the execution of the Fieldbus flow control.	The signal switches from OFF to ON when a command can be input during the execution of the Fieldbus flow control.	This signal switches from ON to OFF when a command cannot be entered during the execution of the Fieldbus flow control .

- *1. Because the BUSY signal OFF time is short, the BUSY signal may appear to remain ON during continuous measurement, the Sensor Controller accepts the Command Request (EXE) signal only when the End Continuous Measurement command is performed.
- *2. This will not be detected while commands received through any other protocol are processed. (Ex.: This signal remains OFF during measurement with the STEP signal in the Parallel communications.) If you use more than one protocol and need to detect command execution, use the BUSY signal in Parallel communications.
- *3. "ON" of this signal does not mean that a command is currently performed. To check whether a command is being executed, refer to the Command Execution Completion (FLG) signal.
- *4. This occurs when the measurement flow is performed in order from the top and the Output Unit is executed, not at the moment when measurement execution was completed.

2-3-14 Output Items

Measurement Results for which Output is Possible (Fieldbus Data Output)

The following data can be output using the processing items related to the Result Output. Measurement values are also referred using processing units such as expressions.

Measurement items	Character string	Description
Judgment	JG	Judgment result
Data 0 to 7	D000 to D007	Results of expressions set for output data 0 to 7.

External Reference Tables (Fieldbus Data Output)

By specifying a number, the following data can be referred using control commands or processing items having a set/get processing unit data function.

Number	Data name	Set/Get	Data range
0	Judgment	Get only	0: No judgment (unmeasured) 1: Judgment result OK -1: Judgment result NG
5 to 12	Data 0 to 7	Get only	<ul style="list-style-type: none"> • ASCII: -999,999,999.9999 to 999,999,999.9999 • Binary: -2,147,483.648 to 2,147,483.647
150	Output type	Set/Get	0: Fixed point 1: Floating point

2-3-15 Command List

This section describes the commands used in EtherNet/IP.

A command with command words in the Command Area first channel can be performed in both tag data link and message communications.

A command without command words in the Command Area first channel can be performed only in message communications.

For details of commands in tag data link, refer to *A-1-4 Command Details for PLC Link, EtherNet/IP, EtherCAT, and PROFINET* on page A-16.

● Execution Commands

First word in Response Area		Function	Reference
+3	+2		
0010	1010	Performs measurement one time.	page A-16
0010	1020	Performs continuous measurement.	page A-16
0010	1030	Ends continuous measurements.	page A-17
0010	1040	Performs test measurement for the specified unit.	page A-17
0010	2010	Clears all measurement result values.	page A-18
0010	2020	Clears the data output buffer.	page A-19
0010	3010	Saves the current system data and scene group data in the Sensor Controller.	page A-20
0010	4010	Registers the model again.	page A-21
0010	5010	Shifts the image display position by the specified amount.	page A-22
0010	5020	Zooms the image display in or out by the specified factor.	page A-23
0010	5030	Returns the display position and display magnification to their default values.	page A-24
0010	7010	Copies the scene data.	page A-25
0010	7020	Deletes the scene data.	page A-25
0010	7030	Moves the scene data.	page A-26
-	-	Registers the specified image data as a registered image.	page A-27
0010	8020	Loads the specified registered image as the measurement image.	page A-28
0010	9010	Returns an entered text string without changing it.	page A-28
-	-	Adds a user account to a specified group ID.	page A-29
-	-	Deletes a specified user account.	page A-30
0010	B010	Branches to the start of the measurement flow (processing unit 0).	page A-31
0010	F010	Restarts the Sensor Controller.	page A-31

● Commands to Get Status

First word in Response Area		Function	Reference
+3	+2		
0020	1000	Gets the current scene number.	page A-32
0020	2000	Gets the current scene group number.	page A-32
0020	4000	Gets the number of the layout that is currently displayed.	page A-33
0020	5010	Gets the number of the Unit that is currently displayed in the specified image display window.	page A-34
0020	5020	Gets the sub-image number that is currently displayed in the specified image display window.	page A-34
0020	5030	Gets the image mode for the specified image display window.	page A-35
0020	7010	Gets the input status (prohibited/permitted) for the Communications Modules.	page A-36
0020	7020	Gets the output status (prohibited/permitted) to an external device.	page A-36
0020	8010	Gets the ON/OFF status for the specified parallel I/O terminal.	page A-37
0020	8020	Gets the ON/OFF status of all parallel terminals except for DI terminals.	page A-39
0020	8030	Gets the ON/OFF status of all parallel DI terminals.	page A-41
-	-	Gets the user name for the user account currently logged in.	page A-43
-	-	Gets the group ID for the account currently logged in.	page A-43
0020	A000	Gets the current state of the operation log.	page A-44

● Commands to Set Status

First word in Response Area		Function	Reference
+3	+2		
0030	1000	Switches to the specified scene number.	page A-45
0030	2000	Switches to the scene group with the specified number.	page A-45
0030	4000	Sets the layout number and switches the image.	page A-46
0030	5010	Sets the number of the Unit to display in the specified image display window.	page A-47
0030	5020	Sets the number of the sub-image to display in the specified image display window.	page A-47
0030	5030	Sets the image mode for the specified image display window.	page A-48
0030	7010	Permits/prohibits inputs to the Communications Modules.	page A-49
0030	7020	Permits/prohibits outputs to external devices.	page A-49
0030	8010	Sets the ON/OFF status of the specified parallel I/O terminal.	page A-50
0030	8020	Sets the ON/OFF status of all parallel terminals except for DO terminals.	page A-52

First word in Response Area		Function	Reference
+3	+2		
0030	8030	Sets the ON/OFF status of all parallel DO terminals.	page A-54
-	-	Switches the currently logged in account.	page A-56
0030	A000	Sets the state of the operation log.	page A-57

● Commands to Read Data

First word in Response Area		Function	Reference
+3	+2		
0040	1000	Gets the specified processing unit data.	page A-58
-	-	Gets the date and time.	page A-58
-	-	Gets the Sensor Controller version information.	page A-59
-	-	Gets settings related to image logging.	page A-60
-	-	Gets the image logging folder name.	page A-61
-	-	Gets the data logging folder name.	page A-62
-	-	Gets the screen capture folder name.	page A-63
-	-	Gets the prefix for the file name in which logged images are saved.	page A-63
0040	4050	Gets the conditions set for data logging.	page A-64
0040	4060	Gets the parallel DI terminal offset data that is set.	page A-64

● Commands to Write Data

First word in Response Area		Function	Reference
+3	+2		
0050	1000	Sets the specified unit data.	page A-65
-	-	Sets the date and time.	page A-66
-	-	Changes the settings related to image logging.	page A-67
-	-	Sets the name for the image logging folder.	page A-68
-	-	Sets the name for the data logging folder.	page A-69
-	-	Sets the name for the screen capture folder.	page A-69
-	-	Sets the prefix for the file name in which logged images are saved.	page A-70
0050	4050	Sets the data logging conditions.	page A-70
0050	4060	Sets the parallel DI terminal offset data.	page A-71

● File Load Commands

First word in Response Area		Function	Reference
+3	+2		
-	-	Loads the scene data.	page A-72
-	-	Loads the scene group data.	page A-73
-	-	Loads the system data.	page A-73
-	-	Loads the system + scene group 0 data.	page A-74

● File Save Commands

First word in Response Area		Function	Reference
+3	+2		
-	-	Saves the scene data.	(p.578)
-	-	Saves the scene group data.	(p.580)
-	-	Saves the system data.	(p.586)
-	-	Saves the image data stored in the the Sensor Controller's memory.	(p.539)
-	-	Saves all image data in the Sensor Controller's memory with ifz format in external storage.	(p.502)
-	-	Saves the last logging image.	(p.543)
-	-	Saves the system + scene group 0 data that is currently used by the Sensor Controller in a file.	(p.504)
-	-	Captures the screen.	(p.520)

2-3-16 Command Response Processing

About control command response processing, the following timing chart describes the ON/OFF timing of signals related to commands to be input.

● Timing Chart for Command Execution

The Command Request (EXE) signal is used as the trigger to input and execute various commands such as measurement execution stored in advance in the external device (such as a PLC) memory.

The Command Completion (FLG) signal turns ON when execution of the control command is completed. Use this as the trigger to turn OFF the Command Request (EXE) signal.

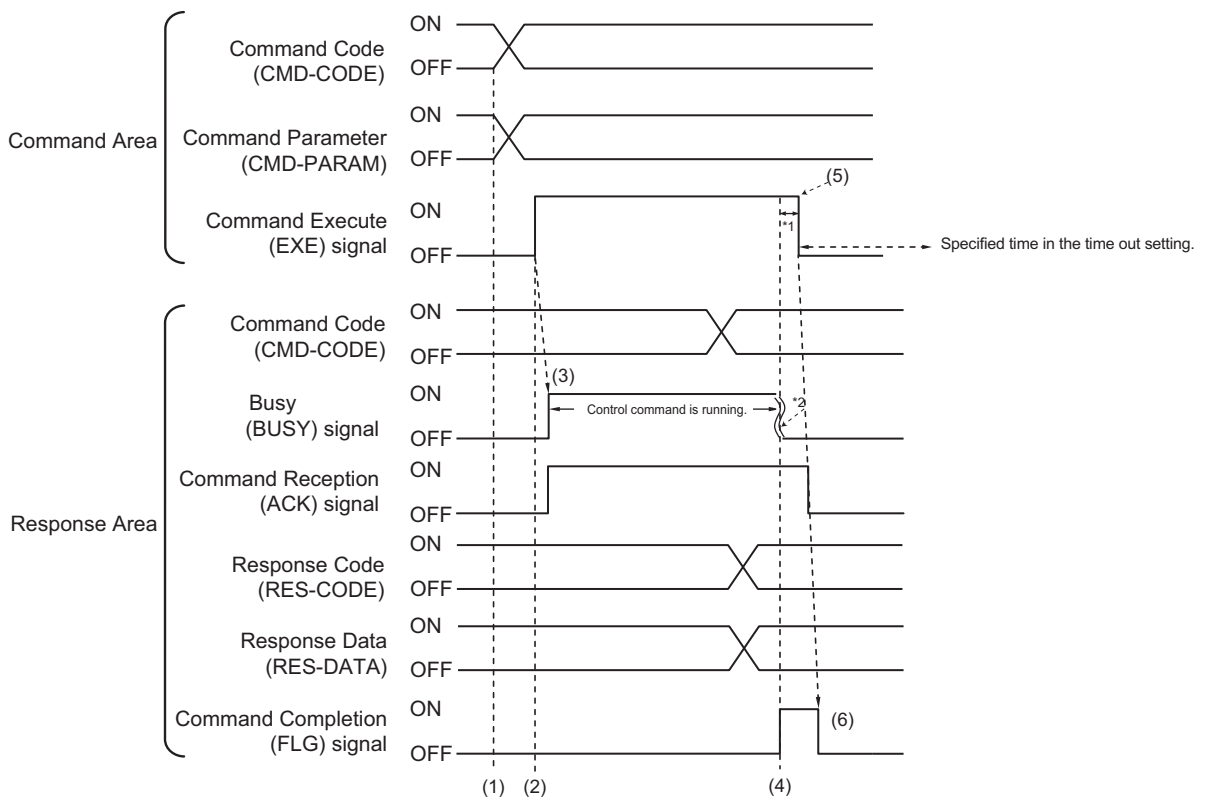

*1: A timeout error will occur if you do not turn off the Command Execution (EXE) signal within 10 seconds after the Command Completion (FLG) signal is turned ON.

Command Completion (FLG) signal and BUSY signal will be forcefully turned OFF.

*2: Busy (BUSY) signal is automatically switched ON to OFF when the command execution is completed.

- (1) The external device such as a PLC sets the command code and command parameters.
- (2) After checking that the BUSY signal and the Command Completion (FLG) signal have turned OFF, the PLC turns ON the Command Request (EXE) signal again to instruct the Sensor Controller to perform it.
- (3) When receiving the instruction the Sensor Controller performs the command and turns ON the ACK signal and the BUSY signal.
- (4) When completing the execution, the Sensor Controller sets the command code, response code, and response data.
The Command Completion (FLG) signal is turned ON.
- (5) The PLC (user) turns OFF the Command Request (EXE) signal when the Command Completion (FLG) signal turns ON.

- (6) When detecting that the Command Request (EXE) signal is OFF, the Sensor Controller automatically turns OFF the Command Reception (ACK) signal and the Command Completion (FLG) signal automatically.

● **Continuous Measurement Command (Without handshaking)**

Continuous execution is used to repeatedly execute measurement by starting the next measurement operation (image input and measurement processing) as soon as single measurement operation (image input and measurement processing) is completed. Continuous measurement is started when the Start Continuous Measurements command is executed and ended when the End Continuous Measurements command is executed.

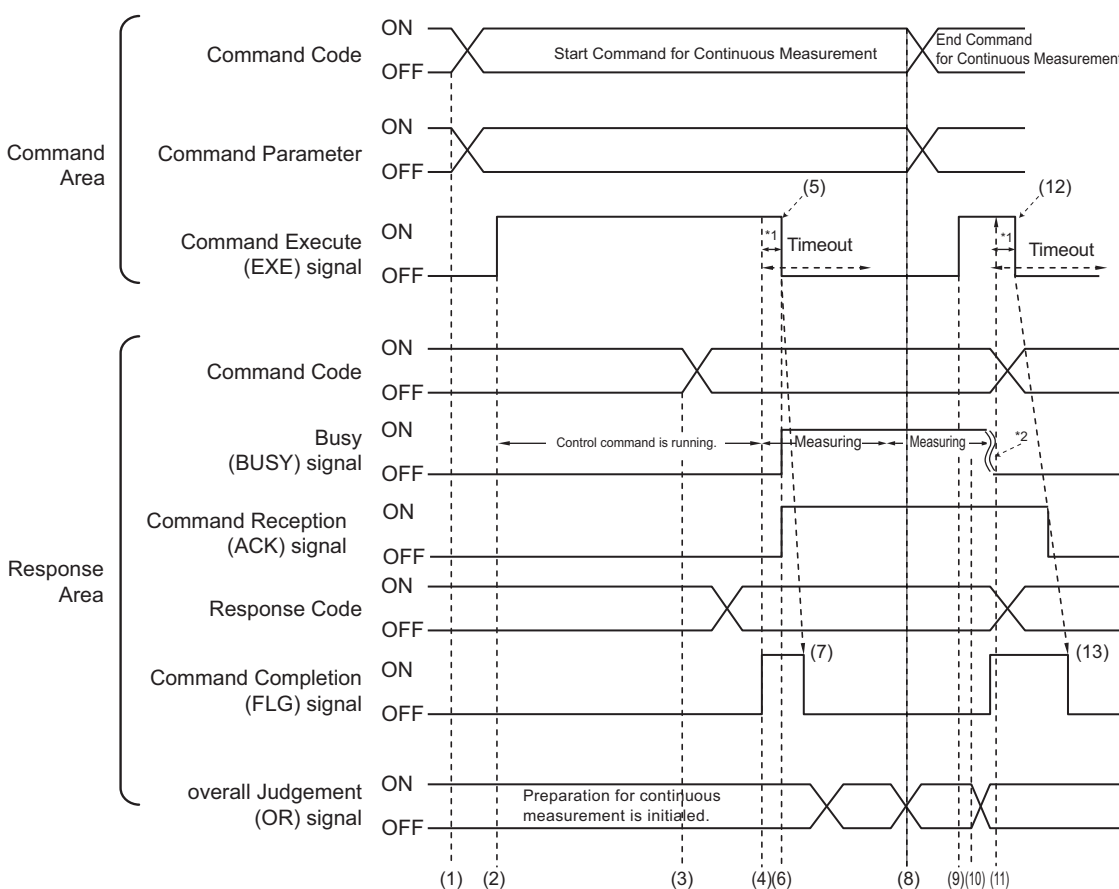

*1: A timeout error will occur if you do not turn off the Command Execution (EXE) signal within 10 seconds after the Command Completion (FLG) signal is turned ON. Command Completion (FLG) signal and BUSY signal will be forcefully turned OFF.
 *2: Busy (BUSY) signal is automatically switched ON to OFF when the command execution is completed.

<Operation to Start Continuous Measurement>

- (1) The PLC (user) sets the Start Continuous Measurements command code.
- (2) After checking that the BUSY signal and the Command Completion (FLG) signal have turned OFF, the PLC turns ON the Command Request (EXE) signal again to instruct the Sensor Controller to perform it.
- (3) When completing the preparations for continuous measurement, the Sensor Controller sets the command code and response code. when preparations for continuous measurement have been completed.
- (4) The Command Completion (FLG) signal is turned ON.

- (5) The PLC (user) turns OFF the Command Request (EXE) signal when the Command Completion (FLG) signal turns ON.
- (6) After detecting that the Command Request (EXE) signal has turned OFF, the Sensor Controller starts continuous measurement and turns ON the Command Reception (ACK) signal and the BUSY signal.
- (7) The Command Completion (FLG) signal is automatically turned OFF.

<Operation to End Continuous Measurement>

- (8) The PLC (user) sets the End Continuous Measurements command code during execution of continuous measurement by the Start Continuous Measurements command.
- (9) The Command Request (EXE) signal is then turned ON and the instruction is sent to the Sensor Controller.



Additional Information

Continuous measurement is not ended in the middle of measurement. When the End Continuous Measurements command was executed, continuous measurement is ended after the measurement in execution was completed.

<Ending Continuous Measurement>

- (10) When receiving the instruction, the Sensor Controller stops continuous measurement and turns OFF the BUSY signal.
- (11) After setting the command code and response code, the Sensor Controller turns ON the Command Completion (FLG) signal.
- (12) When detecting that the Command Completion (FLG) signal turns ON, the PLC (user) turns OFF the Command Request (EXE) signal.
- (13) After detecting that the Command Request (EXE) signal has turned OFF, the Sensor Controller automatically turns OFF the Command Reception (ACK) signal and Command Completion (FLG) signal automatically.



Precautions for Correct Use

- The measurement during continuous measurement is given priority. Therefore, display of the measurement results (total judgment, images, judgment for each processing unit in the flow display, and detailed results) may sometimes not be updated.
 - When continuous measurement is ended, the measurement results from the last measurement will be displayed.
-

● Performing Measurement with the STEP Signal

In addition to inputting and executing the Command Request (EXE) as a trigger, the Measurement Trigger Execute (STEP) signal can be used to perform measurement.

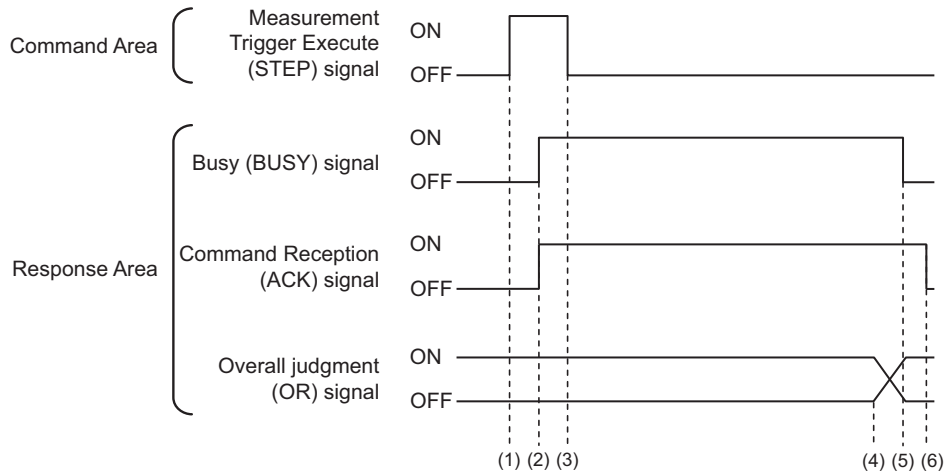

- (1) While the ACK signal is OFF, measurement starts by the rising edge of the Measurement Trigger Execute (STEP) signal.
- (2) The starting measurement turns ON the ACK signal.
- (3) The Measurement Trigger Execute (STEP) signal is turned OFF when the ACK signal turns ON.
- (4) The Overall Judgement (OR) signal is output when measurement is completed.
- (5) The ACK signal is turned OFF when the measurement flow is completed.
- (6) When the measurement flow ends and the measurement execution bit (STEP) is OFF, the processing acceptance (ACK) signal turns OFF.

2-3-17 Data Output

This section describes the ON/OFF timing for signals related to measurement data output after measurement completion using the following timing chart.

● Without handshaking

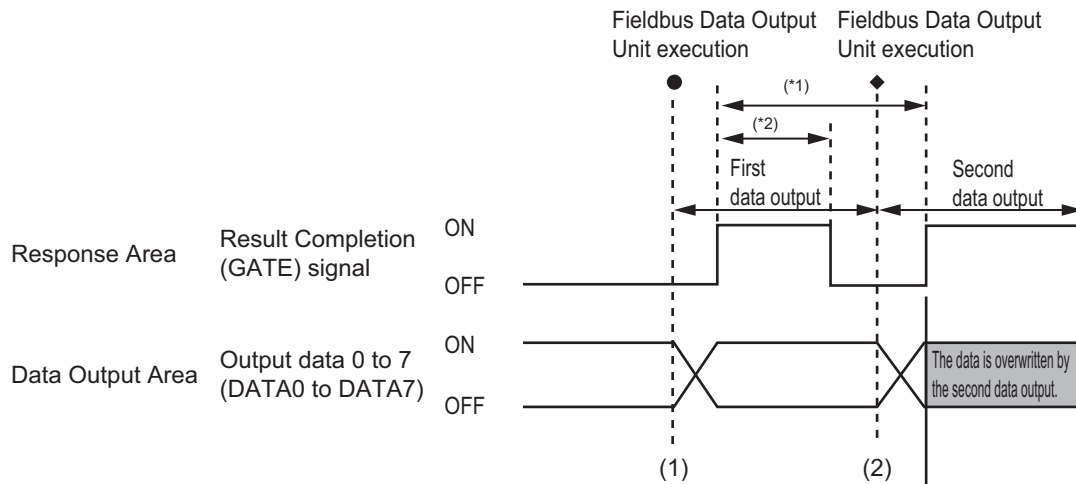

*1, *2: Data is output at the set output period^{*1} and for the set output time.^{*2}
After the data is output, the GATE signal is turned ON and the data is held for the data output time.

- (1) The Sensor Controller outputs data when the Fieldbus Data Output Unit starts execution.
- (2) Data is output each time that the Fieldbus Data Output Unit is performed for the second time or other Fieldbus Data Output Unit is performed. In that time, the output data for the first time is overwritten.



Precautions for Correct Use

- To receive all the output data, set [Output control] to [Handshaking], and then output data. For details, refer to *Setting the EtherNet/IP Output Specifications* on page 2-204, and *Output Format (Fieldbus Data Output)* on page 2-215.
- If any part of data is missing on the external device (such as a PLC) side, or the GATE signal is not output from the FH Sensor Controller, set *Measurement priority to Lower the priority of the measurement process*. Note that the measurement time becomes longer with this setting. For details, refer to *Setting the Status at Startup Startup Settings* in the *Vision System FH/FHV Series User's Manual (Cat. No. Z365)*

● With handshaking

The Result Completion (GATE) signal switches from OFF to ON when the PLC (user) switches the Result Set Request (DSA) signal from OFF to ON.

At that time, data that is possible to output will be output.^{*1}

The PLC (user) switches the DSA signal from ON to OFF under the conditions whether it has received the output data and the Result Completion (GATE) signal has been turned ON.

In the case where multiple Fieldbus Data Output Units perform the data output, the PLC (user) turns the Data Output Request (DSA) signal ON again to instruct it to output the following data, when the Sensor Controller switched the Data Output Completion (GATE) signal from ON to OFF.

*1: Data prepared for output which an Output Unit has been already performed in the measurement flow.

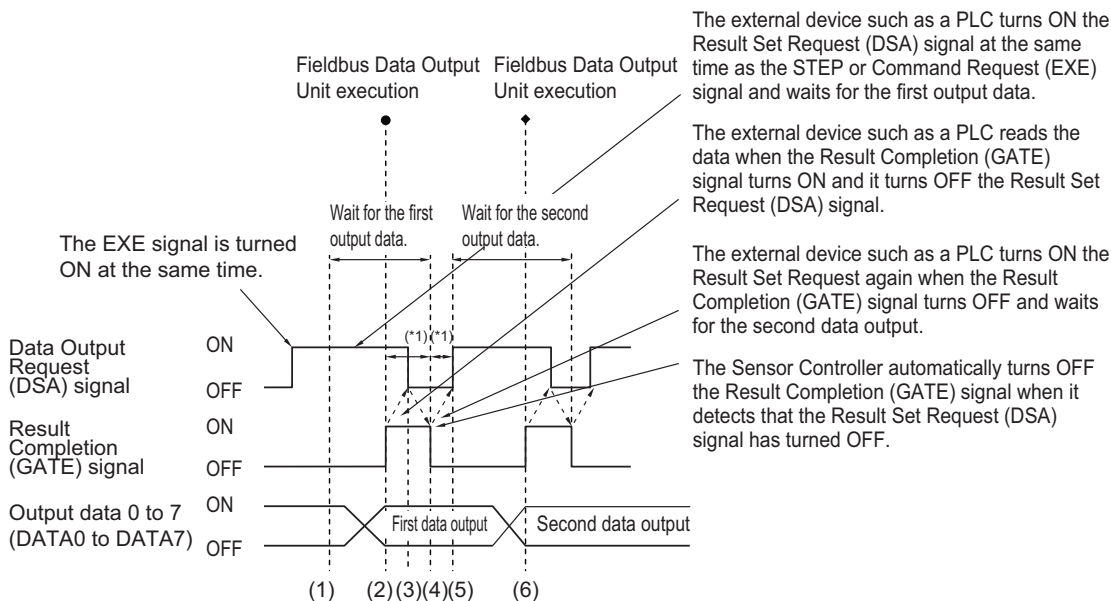

*1 A timeout error will occur if any of the following states continues for longer than the timeout time that is set in the EtherNet/IP settings.
 • If the DSA signal is not turned ON after a certain time elapses from when the Output Unit was executed. (Turn ON the DSA signal at the same time as the measurement trigger command.)
 • If the DSA signal is not turned OFF after a certain time elapses from when the GATE signal turns ON.

- (1) The PLC (user) turns ON the Command Request (EXE) signal and the Data Output Request (DSA) signal at the same time. The output data for the first Fieldbus Data Output Unit can be surely received.
- (2) The Sensor Controller performs the Fieldbus Data Output Unit in the measurement flow. Since the Data Output Request (DSA) signal is ON after the data is written, the Data Output Completion (GATE) signal becomes ON.
- (3) The PLC (user) reads the data when the Result Completion (GATE) signal turns ON and it turns OFF the Result Set Request (DSA) signal.
- (4) The Sensor Controller automatically turns OFF the Result Completion (GATE) signal when it detects that the Result Set Request (DSA) signal has turned OFF.
- (5) If there is more than one Fieldbus Data Output Unit in the measurement flow, the PLC (user) turns ON the Data Output Request (DSA) signal when the Data Output Completion (GATE) signal turns OFF, and then it waits for execution of the next Fieldbus Data Output Unit.
- (6) When the next Fieldbus Data Output Unit is executed, the GATE signal turns ON and the data is output. Receive the second output data and then repeat steps 3 to 5, above.
Repeat steps 3 to 5 for any other data outputs.

2-3-18 Timing Chart

This section describes the ON/OFF timing for signals related to the sequence of operation from control command input until measurement data output after measurement completion using the following timing chart.

● Example 1: Inputting a Measurement Trigger after Switching a Scene without Handshaking

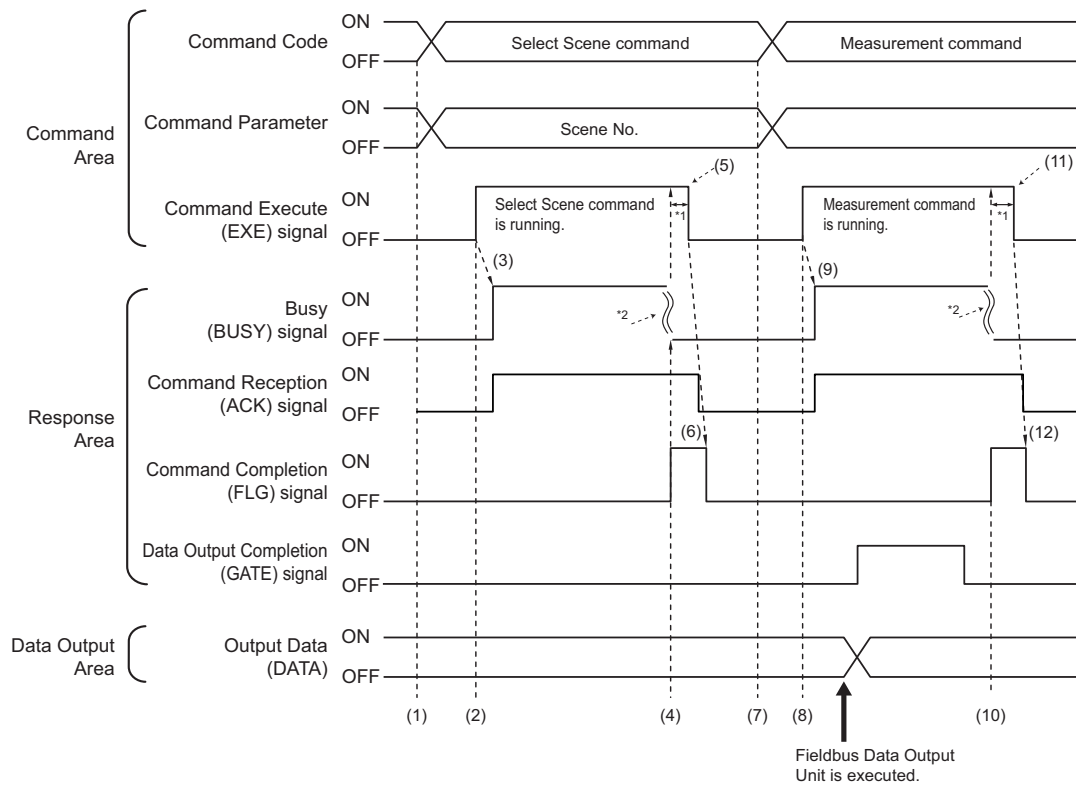

*1: A timeout error will occur if you do not turn off the Command Execution (EXE) signal from external device such as a PLC (master) within 10 seconds. Then Command Completion (FLG) signal and Busy (BUSY) signal will be forced to turn off.

*2: Busy (BUSY) signal is automatically switched ON to OFF when the command execution is completed.

- (1) The external device such as a PLC sets the command code and command parameters for the Switch Scene.
- (2) Next, confirm that the BUSY signal and the Command Completion (FLG) signal have turned OFF and then turn ON the Command Request (EXE) signal. A request is sent to the Sensor Controller.
- (3) The Sensor Controller turns ON the Command Reception (ACK) signal and BUSY signal and switches the scene when the request is received.
- (4) The Command Completion (FLG) signal is turned ON when the scene switching is completed.
- (5) The PLC (user) turns the Command Request (EXE) signal OFF when the Command Completion (FLG) signal is switched from OFF to ON.
- (6) After detecting that the Command Request (EXE) signal has turned OFF, the Sensor Controller automatically turns OFF the Command Reception (ACK) signal and Command Completion (FLG) signal.
- (7) The measurement command code and command parameters are set from the external device such as a PLC.
- (8) The Command Request (EXE) signal is turned ON to execute the measurement command.



Additional Information

To execute a measurement trigger after changing the scene, first confirm that the Command Completion (FLG) signal and the BUSY signal that turned ON for execution of the Select Scene command have turned OFF.

Also, if the BUSY signal is ON for too little time and the external device cannot read it, increase the time that the BUSY signal is ON for changing scenes so that the external device can read the ON state. To do this, change the *Add time* setting for the *Scene switch time*.

Refer to *Setting the Conditions That Are Related to Operation during Measurement* in the *Vision System FH/FHV Series User's Manual (Cat. No. Z365)*.

- (9) The Sensor Controller turns ON the Command Reception (ACK) signal and BUSY signal and performs measurement processing when the request is received.
- (10) The Command Completion (FLG) signal is turned ON when the measurement processing was completed.
- (11) The PLC (user) turns the Command Request (EXE) signal OFF when the Command Completion (FLG) signal turns ON.
- (12) When the Sensor Controller detects that the Command Request (EXE) signal is OFF, it automatically turns OFF the Command Reception (ACK) signal and Command Execution Completion (FLG) signal.

● Example 2: Outputting Data with more than One Output Unit Without Handshaking

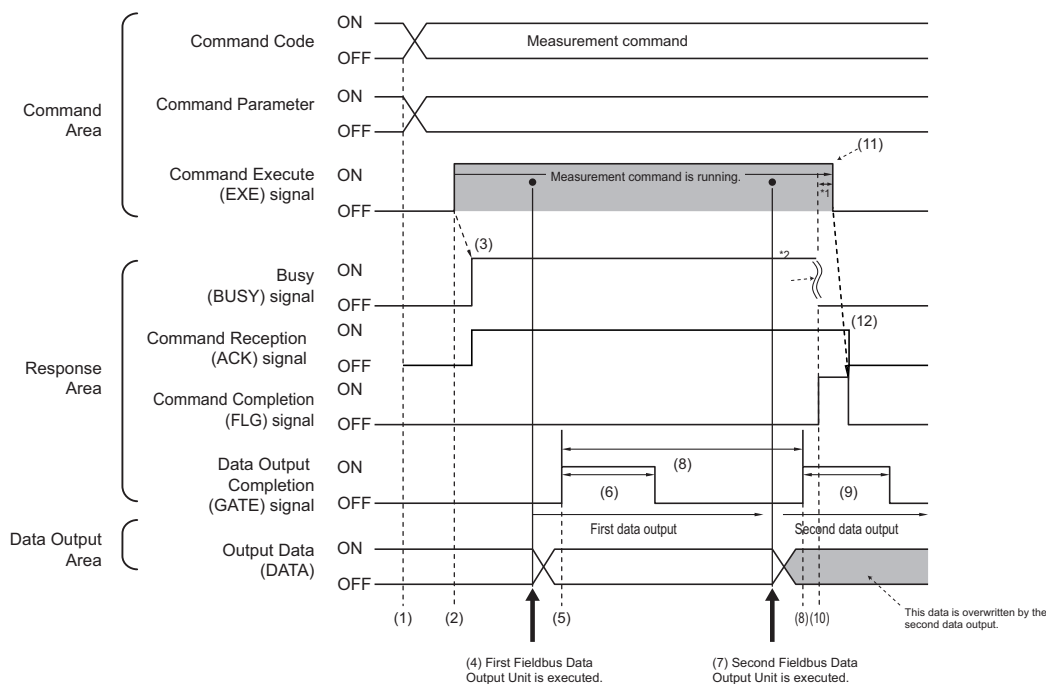

*1: A timeout error will occur if you do not turn off the Command Execution (EXE) signal from external device such as an external device such as a PLC (master) within 10 seconds. Then Command Completion (FLG) signal and Busy (BUSY) signal will be forced to turn off.

*2: Busy (BUSY) signal is automatically switched ON to OFF when the command execution is completed.

- (1) The measurement command code and command parameters are set from the external device such as a PLC.
- (2) Next, confirm that the BUSY signal and the Command Completion (FLG) signal have turned OFF and then turn ON the Command Request (EXE) signal. A request is sent to the Sensor Controller.
- (3) The Sensor Controller turns ON the BUSY signal and executes measurement processing when the request is received.

- (4) When the first Fieldbus Data Output Unit in the measurement flow is executed, the Sensor Controller outputs data for the first Fieldbus Data Output Unit to the Data Output Area.
- (5) The Sensor Controller turns the Data Output Completion (GATE) signal ON when the data is output to the Data Output Area.
- (6) The Sensor Controller turns the Data Output Completion (GATE) signal OFF after the time set at the **Output time** in the EtherNet/IP settings has passed.
- (7) The second Fieldbus Data Output Unit in the measurement flow is executed.
- (8) The Sensor Controller outputs the data for the second Fieldbus Data Output Unit to the Data Output Area after the time set at the **Output period** in the EtherNet/IP settings has passed. At that time, the data for the first Fieldbus Data Output Unit is overwritten.
- (9) The Sensor Controller turns the Data Output Completion (GATE) signal OFF after the time set at the **Output time** in the EtherNet/IP settings has passed.
- (10) The Command Completion (FLG) signal is turned ON when the measurement processing was completed.
- (11) The PLC (user) turns the Command Request (EXE) signal OFF when the Command Completion (FLG) signal turns ON.
- (12) When the Sensor Controller detects that the Command Request (EXE) signal is OFF, it automatically turns OFF the Command Reception (ACK) signal and Command Execution Completion (FLG) signal.



Additional Information

Saving All of the Measurement Results

If you output data from more than one Data Output Unit or for repeatedly measured output data (e.g., for continuous measurement), the same Data Output Area will be overwritten.

To save all of the output data, adjust the *output period* and *output time* that are set in the EtherNet/IP settings so that all of the output data is output and either receive all of the output data by using the Result Completion (GATE) signal or use handshaking control.

Handshaking lets you control data output by using the GATE signal turning ON as a trigger for the data output timing and turning ON the DSA to read the output data. (This is necessary from the second output data item onward.)

Each time that data is output (from the second output on), read the output data and move it to a different part of I/O memory in the external device such as a PLC.

For details of handshaking, Refer to *Data Output Control with Handshaking* on page 1-24.

You can compare the received number of output data and the number of measurements for continuous measurements to check if all of the measurement results have been received.

Use the following method to check the number of measurements that was actually executed.

- Application Example

Set a calculation to count the number of measurements that are executed in the measurement flow.

If you set something like [DO+1], each time a measurement is executed (each time the measurement flow is executed), 1 will be added to DO, so the present value of DO will give you the actual number of measurements.

2-3-19 Communicating with the Sensor Controller using EtherNet/IP Message Communications

Message communications are used to communicate with a PLC that does not support tag data link communications or to use functions such as character string output that are not supported by tag data link.

There are two ways in message communications: one way uses Assembly Object to exchange the same data as for tag data link communications, and another way uses Vision Sensor Object specific for the Sensor Controller to send and receive commands equivalent to non-procedure commands. This document mainly describes the Vision Sensor Object specific for the Sensor Controller and Assembly Object. For the procedures to issue messages, refer to your PLC's manual.

Object Configuration

EtherNet/IP functions of the Sensor Controller have the following objects. These objects can be accessed using message communications.

Class (Object name)	Class ID	Instance ID
Identity Object	1 (01 hex)	1 (01 hex)
Message Router Object	2 (02 hex)	1 (01 hex)
Assembly Object	4 (04 Hex)	100 (64 hex): Output connection (for normal control and for line 0 in Multi-line Random-trigger Mode)
		101 (65 hex): Input connection (for normal control and for line 0 in Multi-line Random-trigger Mode)
		102 (66 hex): Output connection (for line 1 in Multi-line Random-trigger Mode)
		103 (67 hex): Input connection (for line 1 in Multi-line Random-trigger Mode)
		104 (68 hex): Output connection (for line 2 in Multi-line Random-trigger Mode)
		105 (69 hex): Input connection (for line 2 in Multi-line Random-trigger Mode)
		106 (70 hex): Output connection (for line 3 in Multi-line Random-trigger Mode)
		107 (71 hex): Input connection (for line 3 in Multi-line Random-trigger Mode)
		108 (72 hex): Output connection (for line 4 in Multi-line Random-trigger Mode)
		109 (73 hex): Input connection (for line 4 in Multi-line Random-trigger Mode)
		110 (74 hex): Output connection (for line 5 in Multi-line Random-trigger Mode)
		111 (75 hex): Input connection (for line 5 in Multi-line Random-trigger Mode)
		112 (76 hex): Output connection (for line 6 in Multi-line Random-trigger Mode)
		113 (77 hex): Input connection (for line 6 in Multi-line Random-trigger Mode)
		114 (78 hex): Output connection (for line 7 in Multi-line Random-trigger Mode)
115 (79 hex): Input connection (for line 7 in Multi-line Random-trigger Mode)		
Connection Manager Object	6 (06 hex)	1 (01 hex)

Class (Object name)	Class ID	Instance ID
Vision Sensor Object	100 (64 hex)	1 (01 hex): For normal control and for line 0 in Multi-line Random-trigger Mode
		2 (02 hex): For line 1 in Multi-line Random-trigger Mode
		3 (03 hex): For line 2 in Multi-line Random-trigger Mode
		4 (04 hex): For line 3 in Multi-line Random-trigger Mode
		5 (05 hex): For line 4 in Multi-line Random-trigger Mode
		6 (06 hex): For line 5 in Multi-line Random-trigger Mode
		7 (07 hex): For line 6 in Multi-line Random-trigger Mode
		8 (08 hex): For line 7 in Multi-line Random-trigger Mode
TCP/IP Interface Object	245 (F5 hex)	1 (01 hex)
EtherNet Link Object	246 (F6 hex)	1 (01 hex)

Data Types

The data types are predetermined in the EtherNet/IP specifications as shown below.

Data type	Description	Range	
		Min. value	Max. value
BOOL	Boolean	0: FALSE	1: TRUE
SINT	Short integer	-128	127
INT	Integer	-32768	32767
DINT	Double-precision integer	-2 ³¹	2 ³¹ - 1
USINT	Unsigned short integer	0	255
UINT	Unsigned integer	0	65535
UDINT	Unsigned double-precision integer	0	2 ³² - 1
BYTE	Bit string: 8 bits	-	-
WORD	Bit string: 16 bits	-	-
DWORD	Bit string: 32 bits	-	-
REAL	Floating-point real	Single-precision floating-point range	

Class ID: 4 Assembly Object

This object is used to communicate with a PLC that does not support tag data link communications.

• Settings for Data Received by the Sensor Controller

Instance

Setting item	Setting value	Description
Instance	100	For normal control and for line 0 in Multi-line Random-trigger Mode
	102	For line 1 in Multi-line Random-trigger Mode
	104	For line 2 in Multi-line Random-trigger Mode
	106	For line 3 in Multi-line Random-trigger Mode
	108	For line 4 in Multi-line Random-trigger Mode
	110	For line 5 in Multi-line Random-trigger Mode
	112	For line 6 in Multi-line Random-trigger Mode
	114	For line 7 in Multi-line Random-trigger Mode

Attribute

Attribute ID	Access	Name	Data type	Description
03 hex	Set	Data	BYTE array	This sets the command received by the Sensor Controller. The format is the same as an output connection in tag data link communications. For details, refer to <i>Input Connection to the Sensor Controller (External Device such as a PLC (Originator) to Sensor Controller (Target))</i> on page 2-226.
04 hex	Get	Size	UNIT	Number of bytes: 20

Service

Service code	Name	Description
14 (0E hex)	GetAttributeSingle	This attribute gets the attribute value.
16 (10 hex)	SetAttributeSingle	This attribute sets a value for the attribute. Whether an attribute can be set depends on the access attribute of it.

- **Settings for Data Sent by the Sensor Controller**

Instance

Setting item	Setting value	Description
Instance	101	For normal control and for line 0 in Multi-line Random-trigger Mode
	103	For line 1 in Multi-line Random-trigger Mode
	105	For line 2 in Multi-line Random-trigger Mode
	107	For line 3 in Multi-line Random-trigger Mode
	109	For line 4 in Multi-line Random-trigger Mode
	111	For line 5 in Multi-line Random-trigger Mode
	113	For line 6 in Multi-line Random-trigger Mode
	115	For line 7 in Multi-line Random-trigger Mode

Attribute

Attribute ID	Access	Name	Data type	Description
03 hex	Get	Data	BYTE array	This attribute sets the data sent by the Sensor Controller. The format is the same as an input connection in tag data link communications. For details, refer to <i>Output Connection to External Device such as a PLC (Sensor Controller (Originator) to External Device such as a PLC (Target))</i> on page 2-227.
04 hex	Get	Size	UNIT	Number of bytes: 48

Service

Service code	Name	Description
14 (0E hex)	GetAttributeSingle	This attribute gets the attribute value.

Class ID:100 (64 hex) Vision Sensor Object

These objects are specific for the Sensor Controller and can exchange character string data with a format equivalent to commands for the non-procedure protocol. Character strings that are not supported in tag data link can be output.

Instance

Setting item	Setting value	Description
Instance	1	For normal control and for line 0 in Multi-line Random-trigger Mode
	2 to 8	For lines 1 to 7 in Multi-line Random-trigger Mode

Attribute

Attribute ID	Access	Name	Data type	Description
01 hex	Set	Data	BYTE array	This sets the command string sent to the Sensor Controller. (Max. 504 characters) The commands that can be used are equivalent to commands for the Non-procedure protocol. For details, refer to <i>A-1-3 Command List on page A-7</i> .

Service

Service code	Name	Description
50 (32 hex)	SetAttribute	Sets a value for the attribute.

2-3-20 Example for Command Settings

This section describes how to set command strings for Attribute and provides a setting example.

- As the data transmitted from the external device such as a PLC to the Sensor Controller, set a command string equivalent to a command for the non-procedure protocol. Add NULL (00 hex) at the end of the string. No line feed code is required. The size of the transmitted data includes the NULL (00 hex) at the end of the string.
- As the data received by the external device such as a PLC from the Sensor Controller, return string data equivalent to the received string of a command for the non-procedure protocol. NULL (00 hex) is inserted into the delimiter part in the received string. The size of the received data includes the NULL (00 hex) at the end of the string.

Example: When getting the number (0) of the currently used scene:

(Transmitted data: 2 bytes) 53 hex ('S') 00 hex

↓

(Received data: 5 bytes) 30 hex ('0') 00 hex 4F hex ('O') 4B hex ('K') 00 hex



Additional Information

- To acquire data output from a processing unit, such as characters read in Character Inspection, use the external reference data for the processing unit.
Therefore, use the specified command which acquires the parameters or measurement value.
For details, refer to *UNITDATA* or *UD* on page A-164.
 - For the external reference No. which is used in *UNITDATA* or *UD* function, refer to the description of each processing items.
-

2-3-21 EtherNet/IP Troubleshooting

Cannot Input to the Sensor Controller

Problem	Cause	Action
Any input is not accepted.	The EDS file version is different from the firmware one.	Make sure that the EDS file version matches the firmware version.

No Data is Output from the Sensor Controller

Problem	Cause	Action
The GATE signal is not output.	The relationship between the RPI (packet interval) and the <i>Output period</i> for the Sensor Controller is improper.	The RPI needs to be set shorter than the output period.
No data is output at all.	The EDS file version is different from the firmware one.	Make sure that the EDS file version matches the firmware version.
	The communication module is set incorrectly.	Verify that the communication module is set to EtherNet/IP.

A Timeout Error Occurred

Problem	Cause	Action
A handshaking timeout error occurred.	<p>The timing to switch the DSA signal is too slow.</p> <p>The following patterns are considered.</p> <ul style="list-style-type: none"> The DSA signal is not turned ON even after measurement has been completed. The DSA signal is not switched from ON to OFF even after the GATE signal has been turned ON. The DSA signal is not turned ON even after the GATE signal has been turned OFF. 	<p>After the measurement command is performed, turn the Data Output Request (DSA) signal ON and OFF within the timeout time set in the EtherNet/IP communication settings.</p> <p>Or, increase the timeout time.</p>

Problem	Cause	Action
A timeout error for tag data link occurred	<p>Communications between an external device and the Sensor Controller has been temporarily interrupted.</p> <p>The Sensor Controller prioritizes measurement processing and control processing over communication processing.</p> <p>Therefore, as the result of the communication processing delayed due to the heavy loads of the internal processing, communications between an external device and the Sensor Controller may be temporarily interrupted and a communication error may occur.</p>	<p>Set the timeout time for the communication error longer than the processing time of the Sensor Controller or extends the measurement interval. Set the timeout time for the communication error set in tag data link connections as shown below.</p> $\text{Packet interval (RPI value)} \times \text{Timeout value} > \text{Measurement processing time of the Sensor Controller}$

Slow Operation

Problem	Cause	Action
Response and data output is slow.	You try to use a wrong combination for communication protocols such as PLC Link and EtherNet/IP.	Use a proper combination of communication protocols.

Settings are not kept

Problem	Cause	Action
Settings such as Fieldbus Data Output calculations and comments are not kept.	Changed the communication settings after setting the Fieldbus Data Output	Set the Fieldbus Data Output after performing the communication settings.

Communications between the Sensor Controller and external devices are not correctly done.

Problem	Cause	Action
The Sensor Controller cannot communicate with an external device such as a PLC properly. (Only for Ethernet)	The communication settings such as IP address have been changed after the Device information storage tool was performed. (The IP addresses for external devices on the network may have overlapped the IP addresses stored in the Sensor Controller.)	Check that the communication settings such as IP address are correct. (Tool menu - System setting - Communication - Ethernet) Perform the Device information storage tool again. The communication settings in the software will be copied in the Sensor Controller.

Missing of data Occurs

Problem	Cause	Action
<p>Missing of data occurs. Data Output Completion (GATE) signal and BUSY signal are not output from the Sensor Controller.</p>	<p>Since the measurement load on the Sensor Controller becomes heavy, the communication processing for EtherNet/IP is delayed.</p>	<p>Setting <i>Measurement priority</i> to <i>Lower the priority of the measurement process</i> can ease up. Note that the measurement time will delay. For details, refer to Setting the Status at Startup <i>Startup Settings</i> in the <i>Vision System FH/FHV Series User's Manual (Cat. No. Z365)</i></p>

2-4 Communicating by PROFINET

This section describes the communication settings, communication specifications, input/output formats, and the communication timing chart required for communications by PROFINET between the Sensor Controller and an external device.

2-4-1 Overview of PROFINET

PROFINET is a network for industrial use that applies industrial Ethernet (100 Mbps, Full duplex) to PROFIBUS DP. The specifications are open standards managed by PI (PROFIBUS and PROFINET International), and is used in a wide range of industrial devices.

Since PROFINET uses standard Ethernet technology, it can be mixed with various general-purpose Ethernet devices.

This section describes an overview of PROFINET required to use the FH/FHV series with PROFINET. For details of the PROFINET specifications, refer to documents from IEC1158, ICE61784, and PI.

Types of PROFINET

PROFINET has two types of standards: PROFINET IO and PROFINET CBA.

- PROFINET CBA
This is inter-device communication using components and mainly used between controllers.
- PROFINET IO
This controls between a controller and peripheral devices by I/O data.

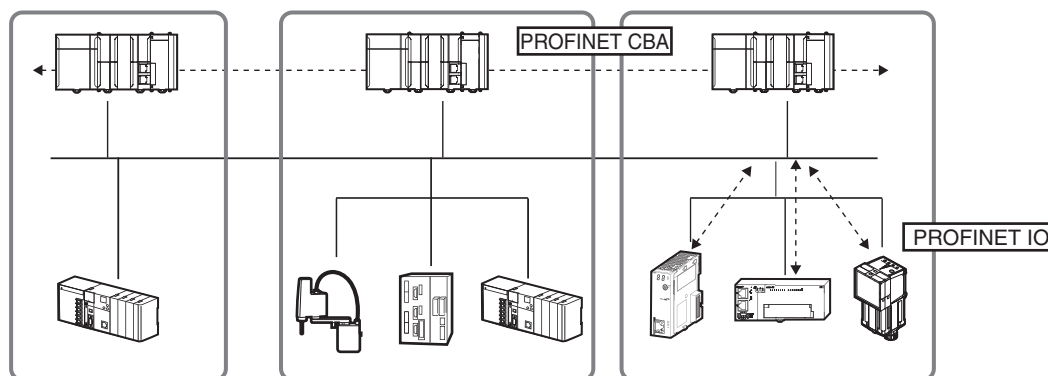

The FH/FHV/FZ5 series support PROFINET IO.

PROFINET IO adopts the same device model as PROFIBUS DP.

The information for each device is described in a GSD (General Station Description) file based on EML (Extensible Markup Language).



Precautions for Correct Use

- For a network that many devices are connected, temporal heavy load on the network may cause communication errors or lower performance such as response delay or packet loss. Perform the verification under actual conditions before use.
- When operating the network under high load condition, perform the verification under actual conditions before use because a certain margin in measurement cycle time is necessary for stable communications.
- Use the EtherNet connector 2 (lower side) when using FH-2000 / FH-5000 series via PROFINET. The EtherNet connector 1 (upper side) cannot be used for PROFINET communications.
- When using PROFINET communications in multi-line random trigger mode with three lines or more, recommend to use FH-5000 series because it is likely to be a high-load state.
- Do not use PROFINET communications together with functions that use PLC Link, Non-procedure, or other Ethernet communications.

PROFINET IO

● Communication Specifications for PROFINET IO

Here, describe the communication specifications for PROFINET IO.

Communication specifications	Method	Description	Support on the FH/FHV series
Periodic data communication method	RT (real-time) communication	Uses standard Ethernet hardware and achieves the same level of performance as the existing Fieldbus.	Supported
	IRT (Isochronous real-time) communication	Provides a higher level of assurance about executing communication within a particular time than RT communication. This is assumed to be used in a system requiring strict real-time such as motion control.	Not supported

PROFINET IO has specified the supported functions per conformance class with an awareness of applications.

Class	Overview	Support on the FH/FHV/FZ5 series
Class A	Supports the basic functions of RT communication.	Supported
Class B	Network diagnosis and redundancy functions used in process automation are added.	Not supported
Class C	Supports IRT communication achieving reliable synchronization.	Not supported

The following functions are defined in Class A.

Function	Overview
Cyclic data exchange	This is real-time data communication between the IO controller and IO devices performed at a determined cycle. This is set by IO data CR.

Function	Overview
Acyclic parameter data/device identification	This is used for parameter settings, IO device configuration, and reading device information. This is set by record data CR.
Device/network diagnosis	This is communication to upload alarms and status from IO devices to the IO controller. This is set by alarm CR.

● Device Types Used in PROFINET IO

The following devices are defined in PROFINET IO.

Method	Description
IO controller	A controller for external devices.
IO device	Sensor devices connected to the IO controller. The FH/FHV series correspond to IO devices.
IO supervisor	A PC or other device to be used for maintenance and diagnosis.

● IO device

IO devices consist of DAPs and IO modules.

The functions and characteristics for the devices are described in a GSD file.

- DAP (Device Access Point):
This is an Ethernet access point to be used in a communication program.
- IO module:
This is composed of the following Slot, Sub-slot, and Index and has one or multiple slots.
- Slot:
This indicates the location for IO modules located in the IO device.
- Sub-slot:
This is an IO interface in the Slot. This defines data types such as bit data and byte data, and the meanings for the data.
- Index:
This is data in the Sub-slot.



Additional Information

When an I/O device is used in PROFINET, the GSD file that describes the device functions and properties is used to configure the network configuration settings.

When the FH/FHV series are used in PROFINET as an I/O device, the GSD file of the FH/FHV series must be installed in the Engineering Tool.

● Data Exchange in PROFINET IO

A connection so-called AR (Application Relation) must be first established to communicate between an IO controller and an IO device.

When the AR connection has once established, data communication between the IO controller and IO device is performed with CR (Communication Relation) that defines the details of the data communication

An IO device can establish an AR with each communication device.

Moreover, multiple CRs can be defined in one AR.

Defining multiple CRs in one AR enables communications when multiple profiles and/or different Sub-slot are required.

Cycle time can be set per each CR and IO too.

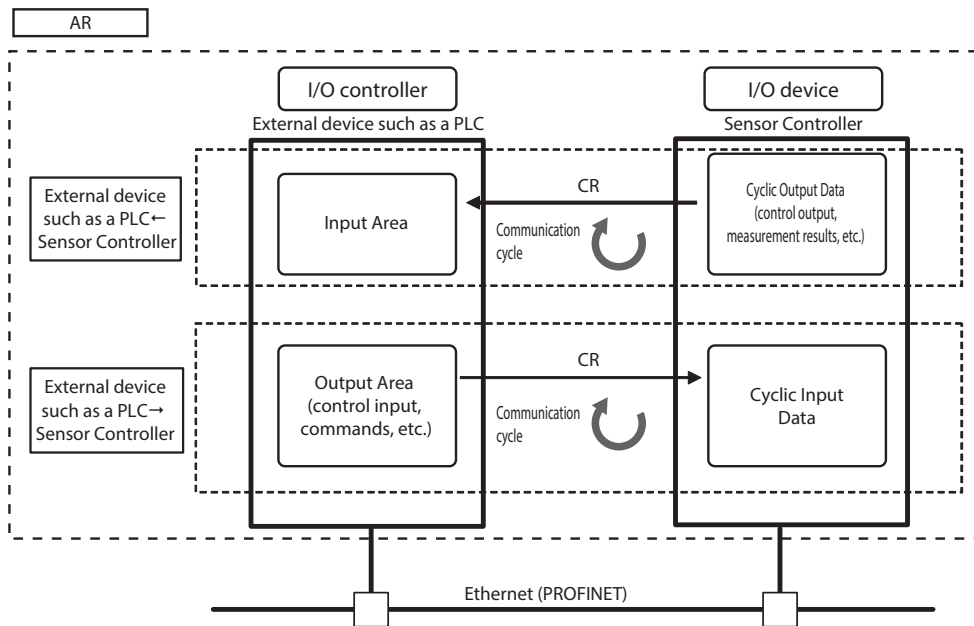

CR is classified into IO data CR, record data CR, and alarm CR.

Within the IO data CR, data communication is performed per an updating task period. Within the other CRs than the IO data CR, communication is performed in between the cyclic data communications.

Within the record data CR, the IO controller transmits commands to the IO devices at any timing and the IO devices send back responses to the IO controller.

2-4-2 PROFINET Communications

You can use PROFINET IO data CR to communicate between the external device such as a PLC and the Sensor Controller to perform control via command/response communications or to output data after measurements.

This Sensor Controller complies with PROFINET conformance class A.

To connect to external devices and communicate using PROFINET, configure the PROFINET IO data CR settings with the engineering tool.

For details on the IO data CR settings in the engineering tool, refer to the manual for each engineering tool.

2-4-3 Communications Processing Flow

In PROFINET communications, the following five communication areas are set in the external device such as a PLC (IO controller).

Input module for the Sensor Controller (Input Data)	(1) Command Area (Command/response method)	This area is used that you write control commands to perform for the Sensor Controller.
	(2) User Input Area	This area is used that you write the data that you defined for the Sensor Controller.
Output module from the Sensor Controller (Output Data)	(3) Response Area (Command/response method)	This area is used that the Sensor Controller writes the results which the control commands written in the Command Area were performed.
	(4) Data Output Area (Data output after measurement)	This area is used that the Sensor Controller writes the output data accompanied with the measurement after measurement performed.
	(5) User Output Area	This area is used that the Sensor Controller writes the data that you defined.

The above five areas are set using an engineering tool such as CX Configurator FDT that can set IO data CR of PROFINET. The areas can be specified by using I/O memory addresses such as CIO or DM.

For details of the IO data CR settings by CX Configurator FDT, refer to *2-4-7 IO Data Communication Settings* on page 2-277.

Moreover, when a non-OMRON PLC or PROFINET unit is connected, download the EDS file for the Sensor Controller from our OMRON website and follow the procedures in the user's manual for the external devices to be connected and in the instruction for the software to set IO data CR.

The flow of PROFINET communications between a external device such as a PLC and the Sensor Controller is as follows.

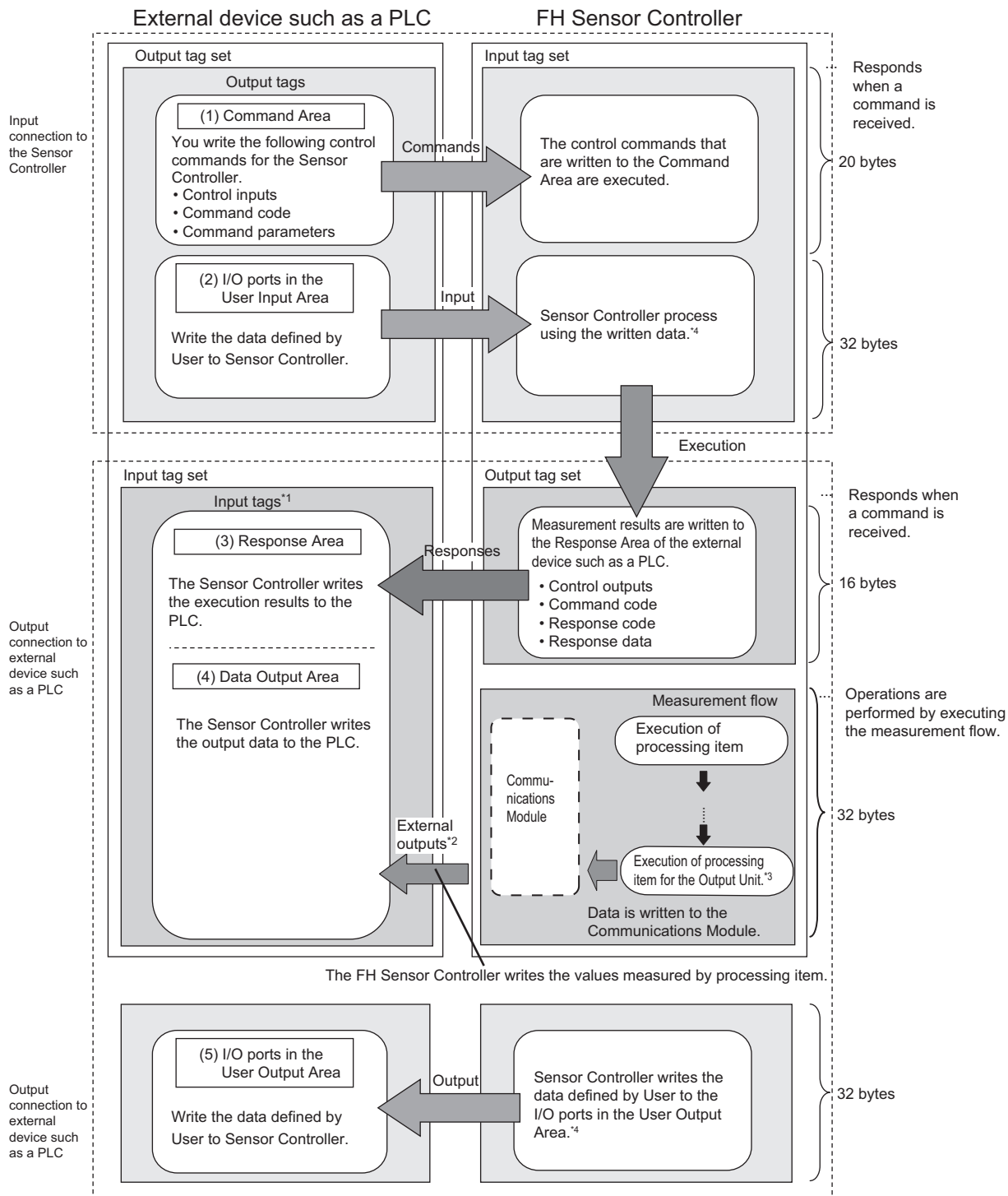

- *1 : The Response Area (3) and Data Output Area (4) are assigned to continuous memory addresses or to variables.
- *2 : You can use output controls (handshaking) to prevent output data from being externally output from the communications buffer until the PLC (master) turns ON the Result Set Request (DSA) signal to request the output data.
- *3 : For details of the Output Units outputting measurement data, refer to *Settings Required for Data Output* on page 1-20.

- *4 : Use the Macro Customization Function to input and output to the User Area. For details of the Macro Customization Function, refer to *PROFINET communication of the IO Module List* in the *Vision System FH/FHV Macro Customize Functions Programming Manual (Cat. No. Z367)*.

2-4-4 Communications Settings

The following settings are required to use PROFINET.

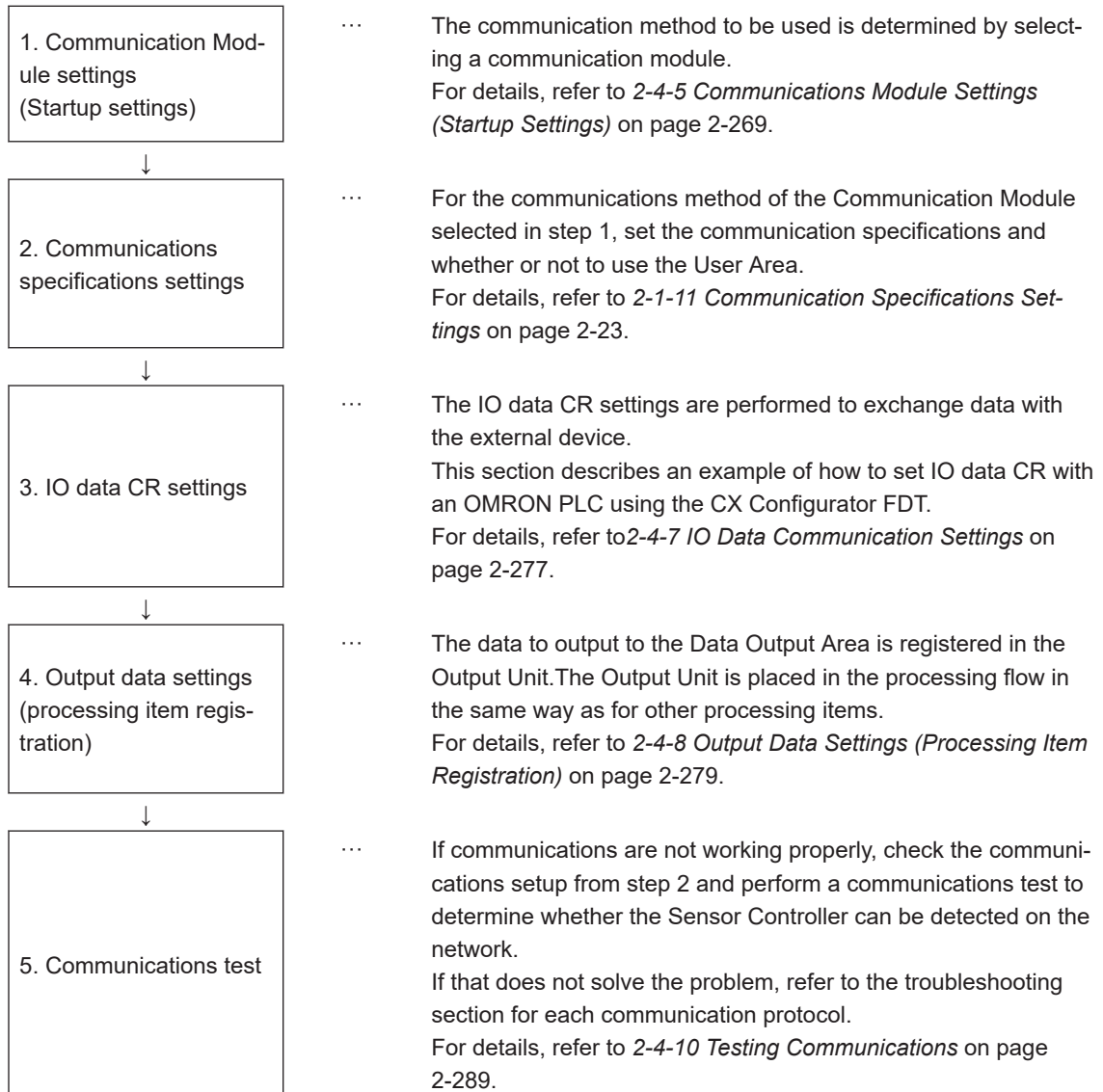

2-4-5 Communications Module Settings (Startup Settings)

The communication method used for communication with the Sensor Controller is selected from the communication modules.

- 1 On the Main window, click **Tool - System Settings** to open the system settings.
- 2 On the Multiview Explorer on the left, select **System settings - Startup - Startup setting** and then click the **Communication** tab.

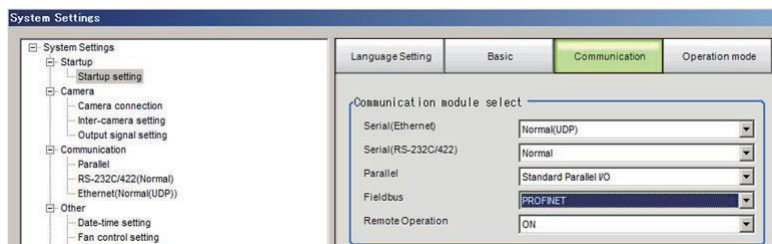

- 3 In the Communication Module Selection Area, select *PROFINET* in the *Fieldbus*, and then click **Apply**.
 - 4 Click **Close** in the bottom of the Window.
 - 5 Click **Data save** in the Toolbox Pane.
- Data save
- 6 On the Main window, click **Function - System restart**.
 - 7 Click **OK** in the System restart dialog box to restart the Sensor Controller. When the Sensor Controller was restarted, the set Communication Module will operate with the default settings.
 - 8 Set the IP address and other parameters for external devices such as a PLC.



Precautions for Correct Use

After you set the Communication Module, always click **Data save** and then restart the Sensor Controller. If the settings are not saved and the Sensor Controller is not restarted, the new Communication Module settings will not be enabled



Additional Information

You can save the Communication Module settings to a file.

Use the *System data* or *System + Scene group 0 data* option for saving settings to a file.

For details, Refer to *Saving Settings Data to the Controller RAM Disk or an External Storage Device* in the *Vision System FH/FHV Series User's Manual (Cat. No. Z365)*.

2-4-6 Communication Specifications Settings

Set the output handshaking and output controls for communications.



Precautions for Correct Use

- Set the Communications Module to *PROFINET* in the startup settings before setting the communications specifications.
For details, Refer to *2-4-5 Communications Module Settings (Startup Settings)* on page 2-269
After you selected the Communication Module, save the settings to the Sensor Controller and restart it.
If you do not restart the Sensor Controller, the selected Communication Module will not be enabled.
Furthermore, if the operation mode is set to the Multi-line Random Trigger Mode, the Communications Modules for lines 1 and higher must also be set to *PROFINET*.
- When using Multi-line Random-trigger Mode, specify different addresses for the sending and receiving areas for each line.

Setting IP Address

Set the IP address for the Sensor Controller.



Precautions for Correct Use

Set the same IP address as it set by I/O controller such as a PLC. In PROFINET communications, an IP address set by I/O controller is prioritized.

- 1** On the Main window, click **Tool - System Settings** to open the system settings.
- 2** In the tree view on the left, select **System Settings - Communication - Ethernet Normal (xyz)** ("xyz" depends on the Communication Module).
The Ethernet view is displayed.
- 3** Set each item.
 - UDP case

Address setting

Obtain an IP address automatically

Use the following IP address

IP address:

Subnet mask:

Default gateway:

DNS server:

Preferred WINS server:

Alternate WINS server:

Address setting 2

Obtain an IP address automatically

Use the following IP address

IP address:

Subnet mask:

Default gateway:

DNS server:

Preferred WINS server:

Alternate WINS server:

Input/Output setting

Input mode: Normal

Input form: ASCII

Output IP address:

Input port No.:

Output port No.: (-1:Same number Input port No.)



Additional Information

- Sensor Controllers of the FH-2000 / FH-5000 series have two Ethernet ports. Set the settings for the two Ethernet ports as follows:
 - Communication Module Settings: Use the same settings for both ports
 - IP Address Setting: Set a different IP address for each Ethernet port. The IP address for the top Ethernet port is set in *Address setting*, and the IP address for the bottom Ethernet port is set in *Address setting 2*. Note that the Sensor Controller prioritizes the bottom port, so when there is a high network load, communication on the top port may be delayed or in some cases communication data may be lost. By using both Ethernet ports simultaneously, you can use the bottom port for PLC Link, Non-procedure, EtherNet/IP, or PROFINET communications with a external device such as a PLC and the top port for FTP or remote operation communications with an external device.
- The following Sensor Controller type has one Ethernet port:
 - FH-L/FHV series
 In this case, the IP address of the Ethernet port is set in *Address setting 2*

Setting item	Setting value [Factory default]	Description
Address Settings Address Settings is only for the following series: FH-2000 / FH-5000 series		Set the IP address for the upper Ethernet port on the Sensor Controller.

Setting item	Setting value [Factory default]	Description
	<ul style="list-style-type: none"> Obtain an IP address automatically. [Use the following IP address] 	<p>Set the IP address for the Sensor Controller. When <i>Obtain an IP address automatically</i> is selected, the IP address of the Sensor Controller will be automatically obtained.</p> <p>When <i>Use the following IP address</i> is selected, set the IP address, subnet mask, and the default gateway address.</p>
IP Address	a.b.c.d a: 1 to 223 b: 0 to 255 c: 0 to 255 d: 0 to 254 [10.5.5.100]	Enter the IP address for the Sensor Controller.
Subnet mask	0.0.0.0 to 255.255.255.255 [255.255.255.0]	Enter the subnet mask address.
Default gateway	a.b.c.d a: 1 to 223 b: 0 to 255 c: 0 to 255 d: 0 to 255 [10.5.5.100]	Enter the default gateway address.
DNS server	a.b.c.d a: 1 to 223 b: 0 to 255 c: 0 to 255 d: 0 to 255 [10.5.5.100]	Enter the DNS server address.
Preferred WINS server	a.b.c.d a: 1 to 223 b: 0 to 255 c: 0 to 255 d: 0 to 255 [0.0.0.0]	Enter the WINS server address.
Alternate WINS server	a.b.c.d a: 1 to 223 b: 0 to 255 c: 0 to 255 d: 0 to 255 [0.0.0.0]	Enter the WINS server address.

Setting item	Setting value [Factory default]	Description
Address Settings 2		
Address Settings is only for the following series: FH-2000 / FH-5000 / FH-L / FHV series		Set the IP address for the lower Ethernet port on the Sensor Controller.

Setting item	Setting value [Factory default]	Description
	<ul style="list-style-type: none"> Obtain an IP address automatically. [Use the following IP address] 	Same as "Address Settings".
IP Address	a.b.c.d a: 1 to 223 b: 0 to 255 c: 0 to 255 d: 0 to 254 [10.5.6.100]	
Subnet mask	0.0.0.0 to 255.255.255.255 [255.255.255.0]	
Default gateway	a.b.c.d a: 1 to 223 b: 0 to 255 c: 0 to 255 d: 0 to 255 [10.5.6.100]	
DNS server	a.b.c.d a: 1 to 223 b: 0 to 255 c: 0 to 255 d: 0 to 255 [10.5.6.100]	
Preferred WINS server	a.b.c.d a: 1 to 223 b: 0 to 255 c: 0 to 255 d: 0 to 255 [0.0.0.0]	
Alternate WINS server	a.b.c.d a: 1 to 223 b: 0 to 255 c: 0 to 255 d: 0 to 255 [0.0.0.0]	Enter the WINS server address.

Setting item	Setting value [Factory default]	Description
--------------	------------------------------------	-------------

Input and Output settings

Output IP Address/TCP Server* ¹	a.b.c.d a: 1 to 223 b: 0 to 255 c: 0 to 255 d: 0 to 254 [0.0.0.0] / [10.5.5.101]* ¹	Enter the IP address for the output destination.
--	--	--

Setting item	Setting value [Factory default]	Description
Input/Output port No.	0 to 65,535*2 [9,600] / [9,876]*3	Set the port number to use for the data input and output with the Sensor Controller.

- *1. When the TCP is used for the connection, *TCP Server* is displayed. Factory default settings are [10.5.5.101].
- *2. When the UDP is used for the connection, do not set the port numbers from "9,700" to "9,700 + line number".
- *3. When the TCP is used for the connection, Factory default settings are [9,876].

- 4** Click **Apply** to finish the settings.
Click **Close** to close the System Settings dialog.



Precautions for Correct Use

- If the operation mode is set to **Multi-line Random-trigger Mode**, set a different I/O port number for each line.
- Change the IP address and subnet mask for **Address setting** and **Address setting 2** as required so that each designate a different network address. If the same network address were specified, communications may not be performed correctly.
- Be sure to change the output IP address from its factory default value in accordance with your network environment.

Setting the PROFINET Output Specifications

- 1** On the Main window, click **Tool - System Settings** to open the system settings.
- 2** Select **System Settings - Communication - PROFINET**.
The PROFINET view is displayed.

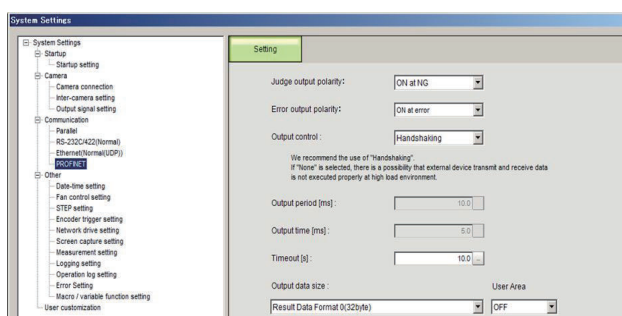

- 3** Set each item.

Setting item	Set value [Factory default]	Description
Judge output polarity	<ul style="list-style-type: none"> • ON at OK • [ON at NG] 	Set the polarity of the judge result output signal. ON at OK: ON when the judgment result is OK. ON at NG: ON when the judgment result is NG.

Setting item	Set value [Factory default]	Description
Error output polarity	<ul style="list-style-type: none"> • [ON at error] • OFF at error 	Set the polarity of the error result output signal.: ON at error: ON when an error occurs. OFF at error: OFF when an error occurs.
Output control	<ul style="list-style-type: none"> • [None] • Handshaking 	Set whether to synchronize with the external device when data is output. Normally, select <i>Handshaking</i> . For details, refer to 2-4-16 <i>Data Output</i> on page 2-309. None: The Sensor Controller outputs measurement results without synchronizing with external devices. Handshaking: The Sensor Controller outputs measurement results with synchronizing with external devices.
Output period [ms] ^{*1}	2.0 to 5,000.0 [10.0]	Valid only when <i>Output control</i> is set to <i>None</i> . Set the cycle by which measurement results are output.
Output time [ms] ^{*2}	1.0 to 1,000.0 [5.0]	Valid only when <i>Output control</i> is set to <i>None</i> . Set the cycle by which measurement results are output. Set the ON time for the GATE signal. Set the time required for an external device to acquire measurement results.
Timeout [s]	0.5 to 120.0 [10.0]	Valid only when <i>Output control</i> is set to <i>Handshaking</i> . A timeout error occurs when no response from external devices is received at the following timing within the time that has been set. In the following cases, a timeout error occurs when the state of each signal does not change within the time that has been set. <ul style="list-style-type: none"> • The DSA signal turns ON after measurement has been completed. • The DSA signal turns OFF after the GATE flag has turned ON.

Setting item	Set value [Factory default]	Description
Output data size *3*4	Result Data Format 0 (32 bytes) Result Data Format 1 (64 bytes) Result Data Format 2 (128 bytes) Result Data Format 3 (256 bytes)	Set the data size to output as measurement results for each line. The settings are reflected at the restart after they were stored. There are four types in the output data size: 32, 64, 128, and 256 bytes. Result Data Format 0 (32 bytes) Out put data 0 to 7 of 4 bytes can be used and total size of the output data is 32 bytes. Result Data Format 1 (64 bytes) Out put data 0 to 15 of 4 bytes can be used and total size of the output data is 64 bytes. Result Data Format 2 (128 bytes) Out put data 0 to 31 of 4 bytes can be used and total size of the output data is 128 bytes. Result Data Format 3 (256 bytes) Out put data 0 to 63 of 4 bytes can be used and total size of the output data is 256 bytes.
User area	<ul style="list-style-type: none"> • [None] • ON 	Set whether or not to use the User Area (user input and output areas) <ul style="list-style-type: none"> • Data type of User Input Area 0 to 3 is DINT. Data type of User Input Area 4 to 5 is LREAL. • Data type of User Output Area 0 to 3 is DINT. Data type of User Output Area 4 to 5 is LREAL.

*1. Set the period so that the interval is longer than the total of *Output time* and *Updating period* (*Update Rate of IO controller*), but less than the measurement interval.

*2. Set this value to *Updating period* (*Update Rate of IO controller*) or larger.

*3. If the total size of the output data exceeded the data size set here, the data will be transmitted at one time but divided into several times.

*4. Set the same value as set at the external device.

4 Click **Apply** to apply the settings.

5 Click **Close** to close the System Settings dialog box.



Precautions for Correct Use

PLC Connection Timeout Interval

Set the *PLC connection timeout interval* so that it is longer than the *measurement processing time*. For the timeout value, refer to 2-3-3 *EtherNet/IP Communications* on page 2-196.

2-4-7 IO Data Communication Settings

This section describes how to set data links for PROFINET.

The communication areas in the external device such as a PLC used for IO data communications with the Sensor Controller are set by assigning the I/O memory address with an engineering tool such as CX Configurator FDT.

When an OMRON controller is connected and communicate via PROFINET, use CX Configurator FDT to assign the I/O memory address.

Here, describes how to set the I/O memory address using CX Configurator FDT. For details, refer to *CJ series PROFINET I/O Controller Unit Operation Manual for NJ series CPU Unit(W511-E2-01)*.



Precautions for Correct Use

When connecting to a CPU Unit of NJ series or CJ series, install the GSD file that defines the IO data CR connection information for the Sensor Controller to a tool (e.g. CX Configurator FDT). Download the GSD file from OMRON's website.

IO Data CR Connection Settings for the Sensor Controller

Each communication area in the external device such as a PLC is set as IO data CR connections as shown below

Settings for the Sensor Controller (Module Settings)

- 1 Add an IO device (FZ/FH-XXXX/FHV7) to the IO controller of the CX Configurator FDT.
- 2 Select **Configuration** -> **Modules** in the IO device (FZ/FH-XXXX/FHV7).
- 3 Add **Input Data** to the slot 1 and **Output Data** to the slot 2.
- 4 Add a Sub-module to the Sub-slot in Slot 1 and set the data format. Likewise, do slot 2. *1
The types of the data format must be the same as the *Output data size* set at PROFINET of the Sensor Controller.

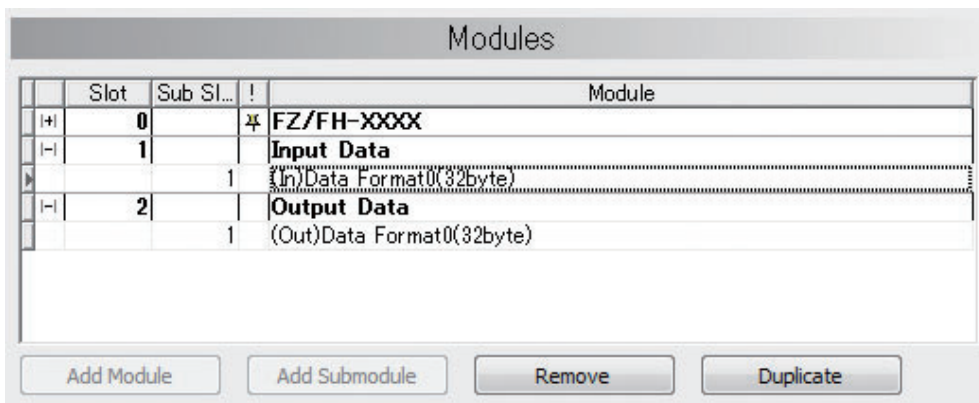

*1: For Multi-line Random-trigger Mode, add the sub-modules corresponding to the number of lines to the *Input Data* and *Output Data* respectively.

Sub-module setting for the Sensor Controller

Data format		Description	
Size	User area	Command Area	Response Area and Output Area
32 bytes	No	(Out) Data Format 0 (32 bytes)	(In) Data Format 0 (32 bytes)
64 bytes		(Out) Data Format 10 (64 bytes)	(In) Data Format 1 (64 bytes)
128 bytes		(Out) Data Format 2 (128 bytes)	(In) Data Format 2 (128 bytes)
256 bytes		(Out) Data Format 3 (256 bytes)	(In) Data Format 3 (256 bytes)
32 bytes	Yes	(Out) Data Format 0 (32 bytes) + User Area	(Out) Data Format 0 (32 bytes) + User Area
64 bytes		(Out) Data Format 1 (64 bytes) + User Area	(In) Data Format 1 (64 bytes) + User Area
128 bytes		(Out) Data Format 2 (128 bytes) + User Area	(In) Data Format 2 (128 bytes) + User Area
256 bytes		(Out) Data Format 3 (256 bytes) + User Area	(In) Data Format 3 (256 bytes) + User Area



Precautions for Correct Use

- For the settings for *IO Device Area* on the IO controller (external device such as a PLC), set the data length to be assigned to the I/O memory address so that it is same or longer than the value indicated in the *Occupied*.
- If the IO data communications were interrupted, increase the value of *Data Hold Factor* and *Watchdog Factor* respectively by clicking **Configuration - IO Device Setup**.

- **Maximum size for the data output in Multiple-line Random-trigger mode**

When a OMRON PROFINET interface unit is used, the allocatable data size to the slots in the Multiple-line Random-trigger mode will be limited up to 416 bytes.

Therefore, refer to the following table and set the total of occupation data size for all lines not to exceed 416 bytes.

Data format		Occupation data size
Size	User area	
32 bytes	No	48 bytes
64 bytes		80 bytes
128 bytes		144 bytes
256 bytes		272 bytes
32 bytes	Yes	80 bytes
64 bytes		112 bytes
128 bytes		176 bytes
256 bytes		304 bytes

2-4-8 Output Data Settings (Processing Item Registration)

Here, set the output items and output format to be used with PROFINET.

This processing item is not available in the FHV series. When you set output data in the FHV series, refer to *2-4-9 Setting Output Data (Numerical Values and Character Strings)* on page 2-283.

Registering Processing Items

Register the processing items for data output in the measurement flow.

- 1 Click **Edit flow** in the Toolbox Pane.
- 2 Select the **Fieldbus Data Output** processing item in the processing item tree.

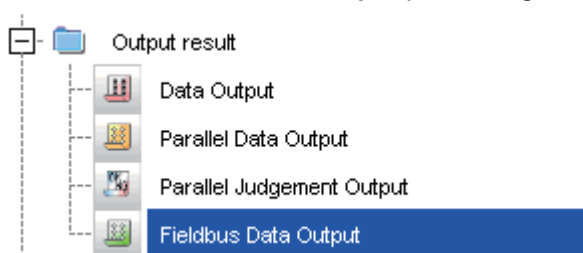

- 3 Click **Append**.
The **Fieldbus Data Output** processing item is added at the bottom of the unit list (flow).

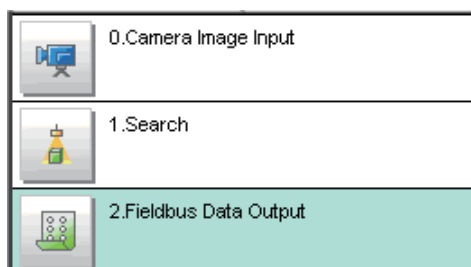

- 4 Click the **Fieldbus Data Output**  icon and set the data output items and data format.
For details of the settings, refer to the following.
Registering the Items to Output on page 2-280



Precautions for Correct Use

Fieldbus Data Output

Perform the communication settings before the settings of Fieldbus Data Output.

Note that if you changed the communication settings after the settings of Fieldbus Data Output, the changed settings will not be displayed on the Fieldbus Data Output setting display.



Additional Information

- The number of outputtable items for single data output processing is 8 depending on data output settings in each lines. If you need to output more data items, use more than one Output Unit.

However, the data is output to the same destination, so if you do not control the output, the output data that was output first will be overwritten by the output data that is output after it. Use the following method to read each set of output data.

Controlling Data Output with Handshaking	<p>If handshaking is used to control data output, the timing of outputting the data is controlled by I/O signals.</p> <p>Each time that data is output, read the output data and move it to a different part of I/O memory in the external device such as a PLC.</p> <p>For detail of handshaking, refer to <i>Data Output Control with Handshaking</i> on page 1-24.</p>
--	---

- Data is output in the order that data output is registered in the measurement flow, i.e., the timing is different for each data output processing item. (Data output is executed in the order that it is executed in the measurement flow.)
For details, refer to *Outputting the Measurement Data* on page 1-18.

Registering the Items to Output

Set the output data with expressions.

- Click the Fieldbus Data Output  icon in the measurement unit list (flow).
- In the Item tab area, click **Setting**.
- In the list, click the output data number to set the expression.

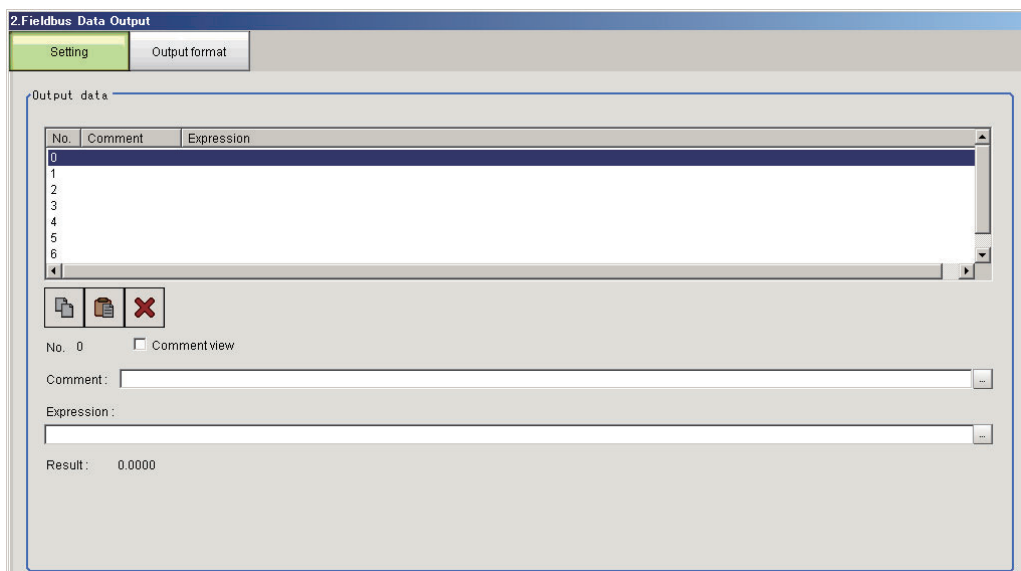

The selected output data number is displayed under the list.

- Click  next to the expression text box and set the expression.

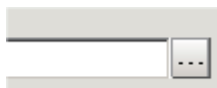

Specify the processing items, measurement results, and measurement data in the expression. Arithmetic or function calculations can be applied to the measurement data to output. For details of the calculation settings, refer to *Calculation* in the *Vision System FH/FHV Series Processing Items Reference Manual (Cat. No. Z341)*.

- 5 Click  for the **Comment** text box and enter the description for the expression. The entered comment will be displayed in the detailed results area on the Main window. For example, *Test* was entered as the comment for the expression 0, *Test* will be displayed instead of *Expression 0* in the detailed results areas on the Main window.
- 6 Repeat step 3 to 5 to set expressions for all of the required output data numbers.



Additional Information

If you delete one of the expressions that is set for output data 0 through 7, the output numbers for all expressions after the deleted expression will stay the same. However, the actual data output will be output as though the list has been shifted forward for the number of expressions that have been deleted.

To prevent data from being written to the wrong locations, use copy and paste to shift the expressions after the deleted number forward.

For details of the Data Output Area, refer to *2-3-12 Memory Allocation* on page 2-226.

Example: If the Expression for Output 1 Is Deleted

Output Item Settings

No.	Comment	Expression
0	Reference SX	U1.SX
1	Reference SY	U1.SY
2	Reference an...	U1.ST
3		
4		

Data Output Destination (Data Output Area)

First word	Bit	
	15	to 0
+8	DATA1 (Reference SX)	
+9		
+10	DATA2 (Reference SY)	
+11		
+12	DATA3 (Reference angle ST)	
+13		



Output 1 is deleted.

Output Item Settings

No.	Comment	Expression
0	Reference SX	U1.SX
1		
2	Reference an...	U1.ST
3		
4		

Data Output Destination (Data Output Area)

First word	Bit	
	15	to 0
+8	DATA1 (Reference SX)	
+9		
+10	DATA3 (Reference angle ST)	
+11		
+12		
+13		

The output numbers assigned to the expressions remain the same, but the data output location is shifted forward for data 3.

Output Format (Fieldbus Data Output)

- 1** Click the Fieldbus Data Output  icon in the measurement unit list (flow).
- 2** In the item tab area, click **Output format**.
- 3** Select the output format.

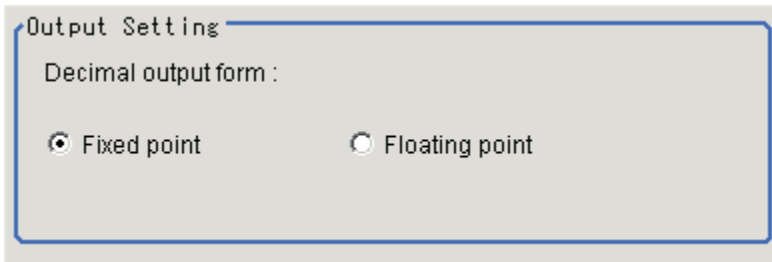

Setting item	Setting value [Factory default]	Description
Decimal output format	<ul style="list-style-type: none"> • [Fixed point] • Floating point 	<ul style="list-style-type: none"> • Fixed point Data is output multiplied by 1,000. ex.: For 123.456, it will be 0001E240 hex. • Floating point Data is output in floating point format. ex.: For -123.4567, it will be C2F6E979 hex.

2-4-9 Setting Output Data (Numerical Values and Character Strings)

Registering Processing Items

Register the processing items for data output in the measurement flow.

- 1 In the Main window, click **Edit flow** in the Toolbox Pane.
- 2 Click **Result output (I/O)** in the processing item tree.

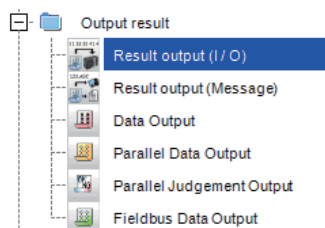

- 3 Click **Append**.
The **Result output (I/O)** processing item is added at the bottom of the unit list (flow).

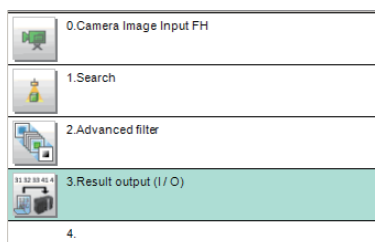

- 4 Click **Result output (I/O)**  icon in the unit list (flow) or **Set** to set the output device and the output data.

Setting the Output Device

Here, set a communication method when data is output.

- 1 Click **Result output (I/O)**  icon in the unit list (flow) or **Set** to set the output device and the output data.
The **Result output (I/O)** setting window is displayed.

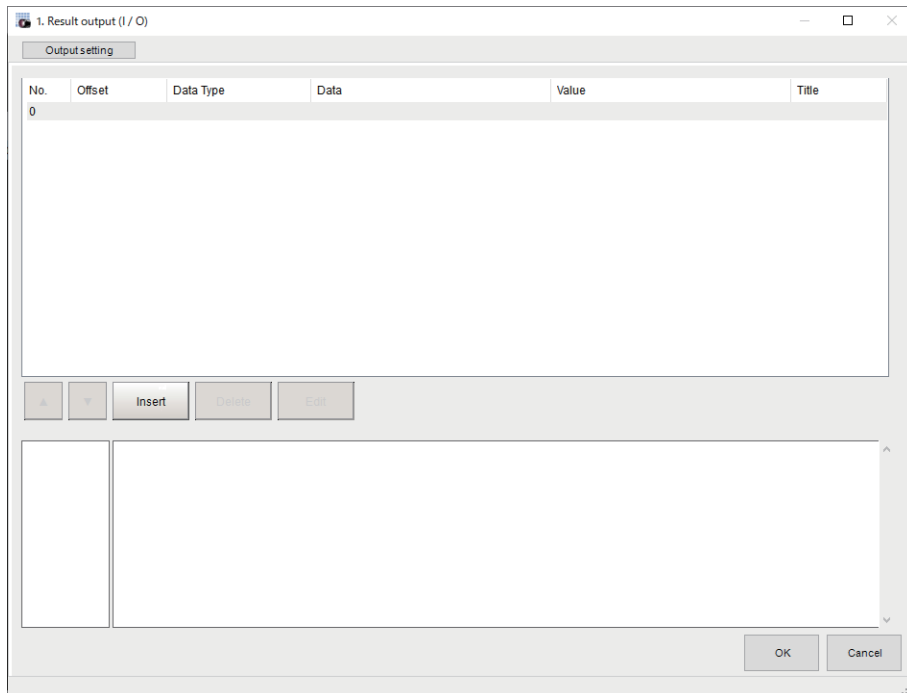

- 2** Click **Output setting**.
The **Output setting** window is displayed.

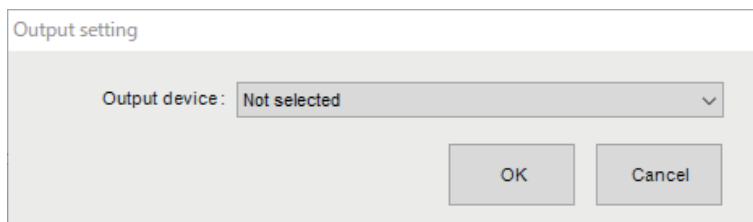

- 3** Click  at the right side of the **Output device**. Select *Fieldbus*.

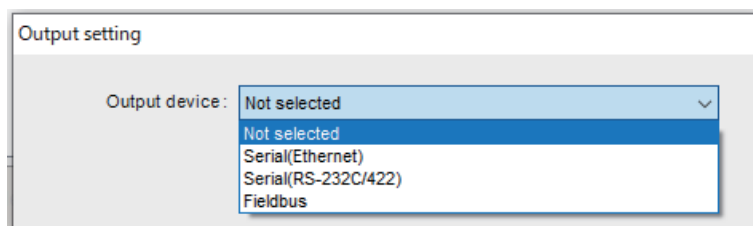

Precautions for Correct Use

- The displayed output device is determined based on the selection of **Communication module** in the **System settings** in the item tab.
- Executing measurements without an output device selected causes a failure (NG: No measurement) in the judgment of the processing unit.

Setting the Output Data

Here, set the data to output such as processing item data or fixed character strings.

- 1 In the item tab area, click **Output data**.
The **Result output (I/O)** setting window is displayed.

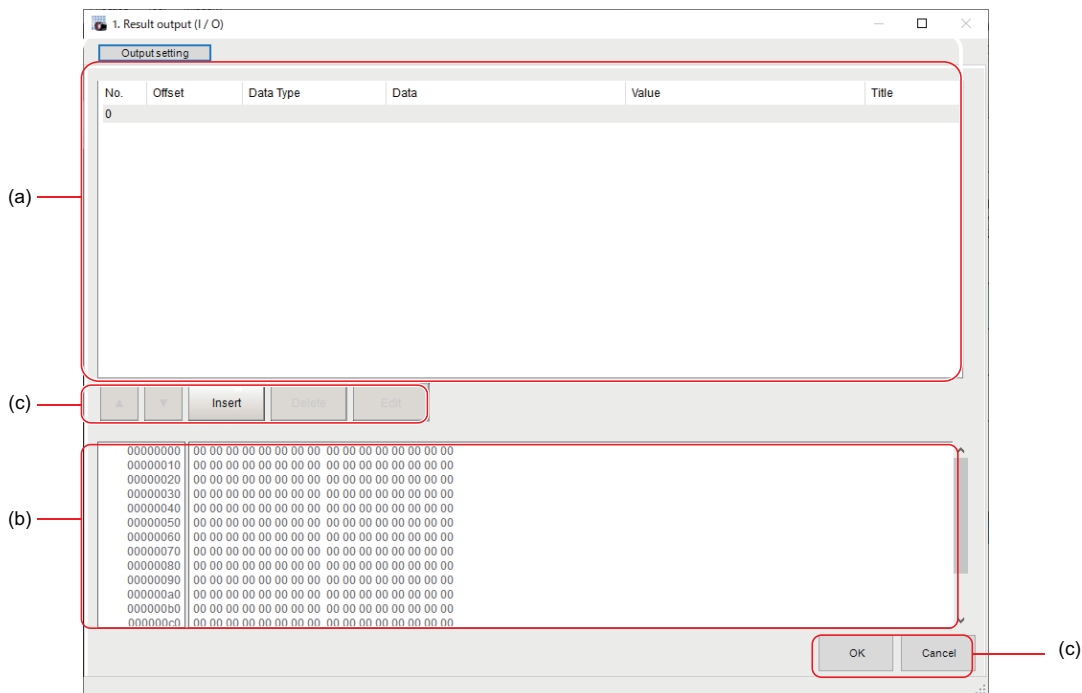

- a) Setting data display area
The No. (output number), Offset (indicating the byte position from the beginning), Data type (integer, double, string), Data, Value, and Title (data description) are displayed in this area. A value is displayed when a variable is assigned to data.
- b) Output data display area
Contents in the output data display area in binary (hex) are displayed in this area.
- c) Button

Button	Description
	Moves the selected data up one position.
	Moves the selected data down one position.
	Adds new data to the selected data position.
	Deletes the selected data. The following data moves up after the deletion.
	Edits the selected data.
	Saves the current settings and returns to the previous view.
	Discards the current settings and returns to the previous view.

- 2 In the list, select the output data number to set the output and then click **Insert**.
The following **Output data editing** dialog box is displayed.

Setting item	Setting value [Factory default]	Description
Data type	<ul style="list-style-type: none"> Integer Double String 	Sets the data type.
Data	—	There are two input methods.*1 <ul style="list-style-type: none"> Enter strings directly Assign variables
Title	—	Enters the description for data.
String settings		Valid when <i>String</i> is selected in the “Data type”.
Size	0 to 4,095 [10]	Sets the number of characters. The number of characters that can be output depends on the data size setting for the tag and tag-set settings in the PLC.
Character code	[0]	Sets the code page according to the language to be used.

*1. Any arithmetic expression cannot be used. If it is used, it will be handled as character strings.

- Character code: Specify the following code page for each language.

Language	Code page	Language	Code page	Language	Code page
Japanese	932	English	1252	Chinese (simplified)	936
German	1252	French	1252	Chinese (traditional)	950
Italian	1252	Spanish	1252	Korean	949
Vietnamese	1258	Polish	1250		

- The default 0 is no language-dependent letters in ANSI code page.
- If non-existing code page is selected, corresponding data is handled as invalid data (NULL).

- 3** Click  at the right side of the **Data type** text box to select the data to output. *Integer*, *Double*, or *String* are selectable.

Data type	Description
Integer	<ul style="list-style-type: none"> Entered data is handled as four-byte data. Allowable entering range is a range of signed INT. When string variables are specified for data, character strings like digits which can be converted into numerical values will be converted and output. When decimal digits are included, they are truncated. Moreover, they are handled as “0” if they are not convertible.

Data type	Description
Double	<ul style="list-style-type: none"> Entered data is handled as eight-byte data. The allowable entering range is a range of eight-byte floating decimal value. When string variables are specified for data, character strings like digits which can be converted into numerical values will be converted and output. Moreover, they are handled as "0" if they are not convertible.
String	<ul style="list-style-type: none"> Entered data is set based on specified <i>Size</i>. Example: Size is four and the entered data is ABCD. ABCD → ABC+NULL The number of allowable entering characters is up to 4,095. If this limit is exceeded, nothing is displayed and output. When NULL is included in the entered character string, the character string following NULL is not output. The following escape sequence codes can be entered. The entered escape sequence codes are handled as fixed character strings. \N: Carriage return, \r: Line feed, \t: Tab, \xXX: ASCII code specified by "XX" (numerical value), \": Double quotation mark, \: Backslash

4 Enter data into *Data* text box.

Data that can be output with one data No. is a range only to be handled as one string.

1) When directly entering an output content into the **Data** text box.

A string enclosed with " " (double quotation marks) handled as one string and the rest following it is not output.

Example: "AA"TEST → only "AA" is output.

2) In the case where assignment variable is assigned o data:

Directly enter a variable name (Scene variable: SC.~) or specify a variable in *Variable assignment* window displayed by clicking .

• Only one variable is valid for one data No.

Example: SC.A\$+SC.B\$ → Only SC.A\$ is output.

• When a fixed string, e.g. AA, is entered before a variable, the subsequent variable is also handled as a fixed string.

Example: AA+SC.AA& → "AA+SC.AA&"

• When "String" is selected in the "Data type" but "Integer" or "Double" is set to the variable, then the variable is converted to a string and then output.

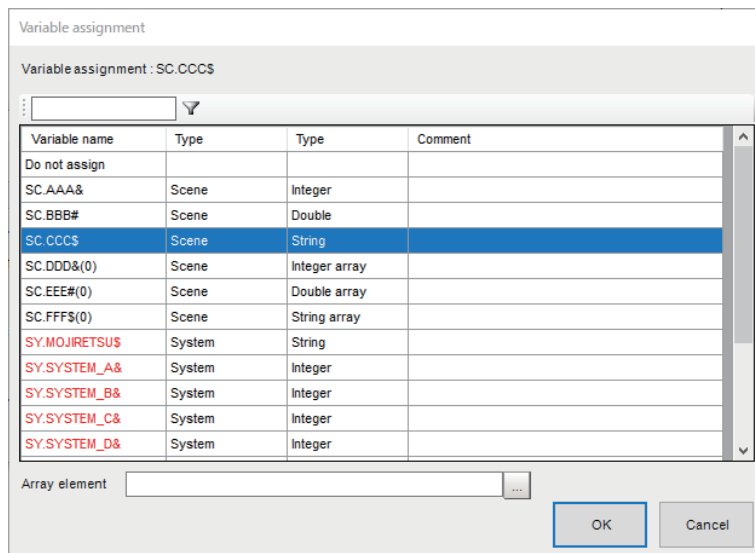

- 5 Enter *Title* that indicates the content of output data.
- 6 When *String* is selected in *Data type*, the following items in *String setting* area also needs to be set.

String setting

Size:

Character code:

When using language dependent characters, please specify the code page according to that language.

Example:

1. Result output (I / O)

Output setting

No.	Offset	Data Type	Data	Value	Title
0	0	Double	SYSTEM_A&	173	
1	8	String	SYMOJIRETSU\$	FH/FJ-XXX	
2	18	Double	111.409385069345		
3	26	String	aiueo		
4	36	Integer	1234		
5					

▲ ▼ Insert Delete Edit

```

00000000 00 00 00 00 00 a0 65 40
00000010 ae 13 8f 5d 33 da 5b 40 61 69 75 65 6f 00
00000020 00 00 00 00 d2 04 00 00 00 00 00 00 00 00 00 00
00000030 00 00 00 00 00 00 00 00 00 00 00 00 00 00 00
00000040 00 00 00 00 00 00 00 00 00 00 00 00 00 00 00
00000050 00 00 00 00 00 00 00 00 00 00 00 00 00 00 00
00000060 00 00 00 00 00 00 00 00 00 00 00 00 00 00 00
00000070 00 00 00 00 00 00 00 00 00 00 00 00 00 00 00
00000080 00 00 00 00 00 00 00 00 00 00 00 00 00 00 00
00000090 00 00 00 00 00 00 00 00 00 00 00 00 00 00 00
000000a0 00 00 00 00 00 00 00 00 00 00 00 00 00 00 00
000000b0 00 00 00 00 00 00 00 00 00 00 00 00 00 00 00
000000c0 00 00 00 00 00 00 00 00 00 00 00 00 00 00 00

```

OK Cancel

- 7 Click **OK** in the end of entering data to close the settings.

2-4-10 Testing Communications

Here, check whether or not the PROFINET communication settings are correct.

If communications cannot be established after the setup, use the following procedures to check the setting details and the communication status.

Before Testing Communications

Here, *Serial (Ethernet) - Normal (UDP)* communication module is used as an example to describe the procedures.

When checking the communication settings, stop the program on the external device such as a PLC.

Checking Communication Settings

Use the following procedures to check whether or not the communication settings are correct.

1. On the Main Window, select [Tool] – [System Settings]. In the tree view on the left, select [System Settings] – [Communication] – [Ethernet Normal (xyz)]. (“xyz” depends on the Communications Module.)
2. Set the IP address of the Sensor Controller. The default settings are as follows:
Address setting: 10.5.5.100
Address setting 2: 10.5.6.100

3. On the Main Window, select [Tool] – [System Settings]. Select [System Settings] – [Communication] – [EtherNet/IP] from the tree view on the left.
4. Click the [Settings] tab.
5. Set the output control. Set whether to provide an interlock with the external device such as a PLC when performing data output.

*** Output Period**

Set the cycle by which measurement results are output. Set the value so that the interval is longer than the output time and shorter than measurement interval.

Output time

Set the interval during which the GATE signal (the signal that tells the external device such as a PLC when to read the measurement results) is ON.

This interval must be longer than the cycle time of the external device such as a PLC and the EtherNet/IP packet interval (RPI). Set these values so that they satisfy the following relationships:

$$RPI < \text{Output time}$$

$$\text{GATE ON time} = \text{Output time}$$

$$\text{GATE OFF time} = \text{Output period} - \text{Output time}$$

(The output period and output time are only valid when output control is set to [None].)

6. This completes the Controller settings. The external device such as a PLC settings are set next.

Checking the Communication Status

Use the ping command to check whether or not the Sensor Controller exists on the Ethernet network. With it, check that the Sensor Controller IP address has been correctly set and is correctly connected to the Ethernet network.



Additional Information

The ping command uses the ICMP protocol to send a response request to a device connected through an Ethernet network and determines the time required to respond to that request. If you properly receive a response from the destination device, the network connection and network settings are correctly set.

- 1 Connect the Sensor Controller and a computer with an Ethernet cable.
Set the high-order digits of the computer IP address to the same values as the Sensor Controller and the low-order one digit to a different value.

<IP Address Setting Example>

Device	Example
Sensor Controller	10.5.5.100 (default)
Computer	10.5.5.101

- 2 Open the Windows command prompt on the computer and perform the ping command.
At the > prompt, type *ping*, followed by a space and the Sensor Controller IP address, and then press *Enter*.

Example:

```
C:\>ping 10.5.5.100
```

- 3 After a few seconds, *Reply from* followed by the IP address of the Sensor Controller (e.g., 10.5.5.100) are displayed, it means that the Sensor Controller is connected to the Ethernet network properly.

Example:

```
Reply from 10.5.5.100: byte=32
```

```
Time<1 ms TTL=128
```

If anything other than *Reply from* is displayed:

The Sensor Controller is not connected to the Ethernet network for some reason. Check the following.

- Are the high-order three digits of the IP addresses for the computer and the Sensor Controller the same?
- Is the Ethernet cable correctly connected?

- 4 Use the ping command to check the communication status of the external device such as a PLC as well.
After you have confirmed the communication status as described above, transmit a measurement command to the Sensor Controller in practice to check the communication operations as the Vision Sensor.

2-4-11 Memory Allocation

This section describes the assignments of the Command Area for the input connection to the Sensor Controller and the Response Area and Output Area for the output connection to the external device such as a PLC.

Input Connection to the Sensor Controller (External device such as a PLC (IO Controller) to Sensor Controller (IO Device))

For the input connections to the Sensor Controller, specifies the control inputs, command codes, command parameters, and User Input Area, which are the Command Area parameters.

● Command Area

Set the first channel in Command Area.	Bit															Name	
	15	14	13	12	11	10	9	8	7	6	5	4	3	2	1		0
+0	E	R						X							S	E	Control input (2 CH)
	R							E							T		
	C							X							E		
	L							E							P		
	R																
+1																	D
																	S
																	A
+2	CMD-CODE															Command Code (2 CH)	
+3																	
+4	CMD-PARAM															Command parameters (Max. 6 CH)	
+5																	
+6																	
+7																	
+8																	
+9																	
+10	User Input Area 0															User Input Area 0	
+11																	
+12	User Input Area 1															User Input Area 1	
+13																	
+14	User Input Area 2															User Input Area 2	
+15																	
+16	User Input Area 3															User Input Area 3	
+17																	
+18	User Input Area 4															User Input Area 4	
+19																	
+20																	
+21																	

Set the first channel in Command Area.	Bit																Name
	15	14	13	12	11	10	9	8	7	6	5	4	3	2	1	0	
+22	User Input Area 5																User Input Area 5
+23																	
+24																	
+25																	

Signal	Signal name	Function
EXE	Command Execution Bit	Performs a command. For details, refer to 2-4-14 <i>Command List</i> on page 2-303.
DSA	Data Output Request Bit	Requests the next data output. For details, refer to 2-4-8 <i>Output Data Settings (Processing Item Registration)</i> on page 2-279.
STEP	Measure Bit	Performs measurement one time.
XEXE	Flow Command Request Bit	Instructs a command execution during the execution of the Field-bus flow control.
ERCLR	Error Clear Bit	Clears the error signal (ERR bit). The ERROR signal of the parallel interface and the ERR LED of the indicator light are not cleared.
CMD-CODE	Command Code	Stores the command code.
CMD-PARAM	Command parameters	Stores the command parameters.
User Input Area 0 to 5	User Input Area 0 5	This area is used that you write the data that you defined for the Sensor Controller. <ul style="list-style-type: none"> Data type of User Input Area 0 to 3 is DINT. Data type of User Input Area 4 to 5 is LREAL.

Output Connection to PLC (Sensor Controller (IO Device) to PLC (IO Controller))

For output connections to the external device such as a PLC, execution results and output data from the Sensor Controller are set. The execution results such as control outputs, command codes, response codes, and response data are output to the Response Area, and the output data from the Sensor Controller or the User Output Area is output to the Data Output Area.



Additional Information

The order in which data is stored depends on the manufacturer of the connected external device such as an external device such as a PLC.

For details, refer to *A-1-1 Parameter Notation Examples for Command Control* on page A-2.

● Response Area

First channel in Response Area	Bit															Name	
	15	14	13	12	11	10	9	8	7	6	5	4	3	2	1		0
+0	E	R				X	X	X			A	R	O		B	F	Control output (2 CH)
+1	R					W	B	F			C	U		U	L		
+2						A	U	L			K	N	R		S	G	Command Code (2 CH)
+3						I	S	G								E	
+4	CMD-CODE															Response Code (2CH)	
+5	RES-CODE																
+6	RES-DATA															Response Data (2 CH)	
+7																	

● Data Output Area

When the User Area is used, data set as the number of output data in the PROFINET output specifications are output followed by the data of the User Output Area. Therefore, the first channel of the User Output Area will be changed according to the number of output data.

The following table indicates the mapping of the Data Output Area and User Output Area when Result Data Format 0 (32 bytes) is selected as the number of the output data.

First channel in Data Output Area	Bit																Name
	15	14	13	12	11	10	9	8	7	6	5	4	3	2	1	0	
+8 +9	DATA0																Output data 0
+10 +11	DATA1																Output data 1
+12 +13	DATA2																Output data 2
+14 +15	DATA3																Output data 3
+16 +17	DATA4																Output data 4
+18 +19	DATA5																Output data 5
+20 +21	DATA6																Output data 6
+22 +23	DATA7																Output data 7
+24 +25	User Output Area 0																User Output Area 0
+26 +27	User Output Area 1																User Output Area 1
+28 +29	User Output Area 2																User Output Area 2
+30 +31	User Output Area 3																User Output Area 3
+32 +33 +34	User Output Area 4																User Output Area 4
+35 +36 +37 +38 +39	User Output Area 5																User Output Area 5

Signal	Signal name	Function
FLG	Command Completion Bit	Turns ON when command execution is completed.
GATE	Data Output Completion Bit	Turns ON when data output is completed.
BUSY	Command Busy Bit	Turns ON when command execution is in progress and turns OFF automatically when the execution was completed.
OR	Overall judgment	Turns ON when the overall judgment is NG. (The OR signal is output only when the <i>Output</i> option is selected in the Adjustment window.)

Signal	Signal name	Function
XFLG	Flow Command Completion Bit	Turns ON when execution of an entered command during the execution for the Fieldbus flow control is completed, i.e. XBUSY: ON to OFF).
XBUSY	Flow Command Busy Bit	Turns ON when an entered command is in execution during the execution of the Fieldbus flow control.
XWAIT	Flow Command Wait Bit	Turns ON when a command can be entered during the execution of the Fieldbus flow control.
RUN	Run Mode	Turns ON when the Sensor Controller is in Run Mode.
ACK	Command Reception bit	Turns ON when Measurement Bit (STEP) or Command Execution Bit is turned ON. Turns OFF after the command execution was completed and either the STEP Bit or EXE Bit is OFF.
ERR	Error Signal	Turns ON when the Sensor Controller detects an error signal. In Multi-line Random-trigger mode, an error for each line is output to the ERR bit of each line. In the case of a system error such as a fan error, it is output to the ERR bit on line 0.
CMD-CODE	Command Code	Returns the executed command code.
RES-CODE	Response Code	Stores the response data for the executed command.
RES-DATA	Response Data	Stores the response data for the executed command.
DATA0 to 7	Output data 0 to 7	Outputs the data set in the output processing item. When more than one processing item exists, data is overwritten on this area by performing handshaking.
User Output Area 0 to 5	User Output Area 0 to 5	This area is used that the Sensor Controller writes the data that you defined using Macro customize functions. <ul style="list-style-type: none"> Data type of the User Output Area 0 to 3 is DINT. Data type of the User Output Area 4 to 5 is LREAL.

Accessing Communication Areas Using Variables by NJ series Controllers

In Controllers of the NJ series, I/O memory addresses assigned to each communication area can be accessed from the user program only via variables.

Follow the procedures below.

● Specify the I/O memory addresses to access each communication area

By setting AT specifications to variables, assigned destination to each communication area can be specified in the unit of the I/O memory address.

1 Setting IO Device Area (CX Configurator FDT)

Directly specify the input and output allocation from the IO controller to the IO device by using the I/O memory addresses allocated to each communication area. (Output Allocation: Command Area to the Sensor Controller, Input Allocation: Response Area and Data Output Area from the Sensor Controller)

Setting example

IO Device Area	Area	Start Address	Length
Output Allocation	DM	0	100
Input Allocation	DM	100	100

2 Setting Variables

Define variables with AT (assigned destination) specifications to the I/O memory addresses assigned to each communication area as shown below.

Setting example

Variable	AT specification	Data type
SensorOut_EXE	D0.0	BOOL
SensorOut_STEP	D0.1	BOOL
SensorOut_ERCLR	D0.15	BOOL
SensorOut_DSA	D1.0	BOOL
SensorIn_FLG	D100.0	BOOL
SensorIn_BUSY	D100.1	BOOL
SensorIn_GATE	D101.0	BOOL
SensorOut_CommandCode	D2	BOOL
SensorIn_ResponseData	D106	DINT
SensorIn_Data	D108	ARRAY[0..7] OF DINT

2-4-12 I/O Signals

The following tables list the signals used to control I/O for PROFINET.

Input Signals

Signal	Signal name	Function	ON/OFF timing	
			OFF to ON	ON to OFF
EXE	Command Request Signal	The user (PLC) turns this signal ON when issuing a command to the Sensor Controller.	The user (PLC) turns this signal ON when issuing a command (instruct the execution) to the Sensor Controller based on the command code and command parameters.	The user (PLC) switches this signal from ON to OFF when the Sensor Controller turns the Command Completion (FLG) signal ON.* ¹
DSA (Used only for handshaking output control)	Data Output Request Signal	During handshaking, the user (PLC) issues this signal to the Sensor Controller to request to output externally the measured results performed in the measurement flow. When this signal is ON while an Output Unit (Fieldbus Data Output Unit) in the measurement flow is performed, the Sensor Controller outputs the data of the processing item.	<ul style="list-style-type: none"> The user (PLC) turns this signal ON when requesting the measurement data to output externally.*³ This DSA signal is turned ON at the same time as the Trigger (STEP) or Command Request (EXE) signal switches from OFF to ON. When more than one Output Units is used to output more than eight data, turn ON this DSA signal again after the GATE signal for the first data output turns OFF. For details, refer to <i>2-4-17 Timing Chart</i> on page 2-311.	The user (PLC) switches this signal from ON to OFF when the Sensor Controller turns the GATE signal ON.* ²
ERCLR	Error Clear Bit	Clears the error signal (ERR bit). The ERROR signal of the parallel interface and the ERR LED of the indicator light are not cleared.	The user (PLC) switches the signal from OFF to ON when the Error (ERR) signal from the Sensor Controller is turned OFF.	This signal is turned OFF when the user (PLC) detected the Error (ERR) signal turned OFF.

Signal	Signal name	Function	ON/OFF timing	
			OFF to ON	ON to OFF
XEXE	Flow Command Request	This is turned on when a command will be performed while PLC Link, Fieldbus, or parallel flow control are performed.	The user (PLC) switches the signal from OFF to ON when it instructs an entered command execution during the execution of the Fieldbus flow control.	This signal switches from ON to OFF when the Flow Command Completion (XFLG) signal is turned ON.
STEP	Measurement Trigger	This is turned on when measurements will be performed.	This signal turns ON from the PLC) to perform measurement after confirming that the BUSY signal and the Command Execution Completion (FLG) signal have turned OFF.	The user (PLC) switches this signal from ON to OFF after detecting that the Sensor Controller turned the BUSY signal ON.

- *1. If the Command Request (EXE) signal does not switch from ON to OFF within 10 seconds after the Command Completion (FLG) signal was turned ON, a timeout error will occur, and the FLG signal is forced to be turned OFF.
- *2. If the Data Output Request (DSA) signal does not switch from OFF to ON within the time set at the "Timeout" in the settings after the Data Output Completion (GATE) signal turned ON, a timeout error will occur and the measurement data prepared for output will be discarded.
- *3. If the Data Output Request (DSA) signal does not switch from OFF to ON within the time set at the "Timeout" in the settings after the measurement processing started by the Measurement Trigger (STEP) signal or the Command Request (EXE) signal turned ON, a timeout error will occur and the measurement data prepared for output will be discarded.

Output Signals

Signal	Signal name	Function	ON/OFF timing	
			OFF to ON	ON to OFF
BUSY	Busy	This signal indicates that external inputs such as commands cannot be accepted. Issue a command when this signal is OFF. *1*2*3	This signal turns ON when the Sensor Controller receives a command from the user (PLC). (After the EXE signal switches from OFF to ON.)	The signal turns OFF when the command execution is completed.
FLG	Command Execution Completion	The Sensor Controller uses this signal to inform the PLC that command execution has been completed.	The signal turns ON when the Sensor Controller completes execution of a received command.	This signal is turned OFF when the user (PLC) switches the Command Request (EXE) signal from ON to OFF.

Signal	Signal name	Function	ON/OFF timing	
			OFF to ON	ON to OFF
GATE	Data Output Completion Signal	<p>The signal informs the PLC of the timing to load output data. "ON" of this signal indicates that the Sensor Controller is outputting the data.</p> <p>The user (PLC) starts to load the data when the signal turns ON.</p>	<ul style="list-style-type: none"> Without handshaking The signal turns ON when the Sensor Controller performs the Output Unit (Fieldbus Data Output Unit)*⁴ in the measurement flow and is ready for the data output. With handshaking The signal turns ON when the Sensor Controller performs the Output Unit (Fieldbus Data Output Unit) *⁴ in the measurement flow and is ready for the data output and the Data Output Request (DSA) signal is ON. 	<ul style="list-style-type: none"> Without handshaking The signal turns OFF after the <i>Output Time</i> set in the settings has passed. With handshaking This signal is turned OFF when the user (PLC) switches the Data Output Request (DSA) signal from ON to OFF.
ERR	Error Signal	<p>The signal indicates that the Sensor Controller detects the following errors.</p> <p>For details of the errors, refer to <i>Error Messages and Troubleshooting</i> in the Vision System FH/FHV Series User's Manual (Cat. No. Z365)..</p>	The signal turns ON if the Sensor Controller detects an error.	The signal turns OFF when the error is fixed and the user (PLC) turns the Error Clear (ERCLR) signal ON.
RUN	Run Mode	The signal indicates that the Sensor Controller is in RUN Mode.	The signal turns ON when the Sensor Controller is in Run Mode.	The signal turns OFF when the Sensor Controller is in Adjustment Mode.
OR	Overall judgment	The signal indicates the overall judgment results.	The signal turns ON when the overall judgment is NG.	The signal turns OFF when the overall judgment is OK.
ACK	Command Reception	The signal indicates that a command is received. Even BUSY is not output due to a heavy load, it surely detects the completion of the command processing execution.	The signal is turned ON when Measure Bit (STEP) or Command Execution Bit (EXE) is received.	The signal switches from ON to OFF after the execution completed and either the STEP Bit or EXE Bit is OFF.

Signal	Signal name	Function	ON/OFF timing	
			OFF to ON	ON to OFF
XFLG	Flow Command Execution Completion	The signal indicates that a command performed during execution of the Fieldbus flow control has been completed.	The signal is turned ON when a command performed has been completed (XBUSY switched from ON to OFF) during execution of Fieldbus flow control.	The signal is turned OFF when the Flow Command Request (XEXE) signal switches from ON to OFF during the execution for the Fieldbus flow control.
XBUSY	Flow Command Busy Bit	The signal indicates that a command entered during the execution of the Fieldbus flow control is in execution.	The signal switches from OFF to ON when a command entered during the execution for the Fieldbus flow control is in execution.	The signal switches from ON to OFF when a command execution entered during the execution of the Fieldbus flow control has been completed.
XWAIT	Flow Command Wait Bit	The signal indicates that a command entered can be accepted during the execution of the Fieldbus flow control.	The signal switches from OFF to ON when a command can be input during the execution of the Fieldbus flow control.	This signal switches from ON to OFF when a command cannot be entered during the execution of the Fieldbus flow control .

- *1. Because the BUSY signal OFF time is short, the BUSY signal may appear to remain ON during continuous measurement, the Sensor Controller accepts the Command Request (EXE) signal only when the End Continuous Measurement command is performed.
- *2. This will not be detected while commands received through any other protocol are processed. (Ex.: This signal remains OFF during measurement with the STEP signal in the Parallel communications.) If you use more than one protocol and need to detect command execution, use the BUSY signal in Parallel communications.
- *3. "ON" of this signal does not mean that a command is currently performed. To check whether a command is being executed, refer to the Command Execution Completion (FLG) signal.
- *4. This occurs when the measurement flow is performed in order from the top and the Output Unit is executed, not at the moment when measurement execution was completed.

2-4-13 Output Items

Measurement Results for which Output is Possible (Fieldbus Data Output)

The following data can be output using the processing items related to the Result Output. Measurement values are also referred using processing units such as expressions.

Measurement items	Character string	Description
Judgment	JG	Judgment result
Data 0 to 7	D000 to D007	Results of expressions set for output data 0 to 7.

External Reference Tables (Fieldbus Data Output)

By specifying a number, the following data can be referred using control commands or processing items having a set/get processing unit data function.

Number	Data name	Set/Get	Data range
0	Judgment	Get only	0: No judgment (unmeasured) 1: Judgment result OK -1: Judgment result NG
5 to 12	Data 0 to 7	Get only	<ul style="list-style-type: none"> • ASCII: -999,999,999.9999 to 999,999,999.9999 • Binary: -2,147,483.648 to 2,147,483.647
150	Output type	Set/Get	0: Fixed point 1: Floating point

2-4-14 Command List

This section describes the commands used in PROFINET.

A command with command words in the Command Area first channel can be performed in IO data communications.

For details of commands in IO data communications, refer to *A-1-4 Command Details for PLC Link, EtherNet/IP, EtherCAT, and PROFINET* on page A-16.

● Execution Commands

First word in Response Area		Function	Reference
+3	+2		
0010	1010	Performs measurement one time.	page A-16
0010	1020	Performs continuous measurement.	page A-16
0010	1030	Ends continuous measurements.	page A-17
0010	1040	Performs test measurement for the specified unit.	page A-17
0010	2010	Clears all measurement result values.	page A-18
0010	2020	Clears the data output buffer.	page A-19
0010	3010	Saves the current system data and scene group data in the Sensor Controller.	page A-20
0010	4010	Registers the model again.	page A-21
0010	5010	Shifts the image display position by the specified amount.	page A-22
0010	5020	Zooms the image display in or out by the specified factor.	page A-23
0010	5030	Returns the display position and display magnification to their default values.	page A-24
0010	7010	Copies the scene data.	page A-25
0010	7020	Deletes the scene data.	page A-25
0010	7030	Moves the scene data.	page A-26
0010	8020	Loads the specified registered image as the measurement image.	page A-27
0010	9010	Returns an entered text string without changing it.	page A-28
0010	B010	Branches to the start of the measurement flow (processing unit 0).	page A-31
0010	F010	Restarts the Sensor Controller.	page A-31

● Commands to Get Status

First word in Response Area		Function	Reference
+3	+2		
0020	1000	Gets the current scene number.	page A-32
0020	2000	Gets the current scene group number.	page A-32
0020	4000	Gets the number of the layout that is currently displayed.	page A-33
0020	5010	Gets the number of the Unit that is currently displayed in the specified image display window.	page A-34

First word in Response Area		Function	Reference
+3	+2		
0020	5020	Gets the sub-image number that is currently displayed in the specified image display window.	page A-34
0020	5030	Gets the image mode for the specified image display window.	page A-35
0020	7010	Gets the input status (prohibited/permitted) for the Communications Modules.	page A-36
0020	7020	Gets the output status (prohibited/permitted) to an external device.	page A-36
0020	8010	Gets the ON/OFF status for the specified parallel I/O terminal.	page A-37
0020	8020	Gets the ON/OFF status of all parallel terminals except for DI terminals.	page A-39
0020	8030	Gets the ON/OFF status of all parallel DI terminals.	page A-41
0020	A000	Gets the current state of the operation log.	page A-44

● Commands to Set Status

First word in Response Area		Function	Reference
+3	+2		
0030	1000	Switches to the specified scene number.	page A-45
0030	2000	Switches to the scene group with the specified number.	page A-45
0030	4000	Sets the layout number and switches the image.	page A-46
0030	5010	Sets the number of the Unit to display in the specified image display window.	page A-47
0030	5020	Sets the number of the sub-image to display in the specified image display window.	page A-47
0030	5030	Sets the image mode for the specified image display window.	page A-48
0030	7010	Permits/prohibits inputs to the Communications Modules.	page A-49
0030	7020	Permits/prohibits outputs to external devices.	page A-49
0030	8010	Sets the ON/OFF status of the specified parallel I/O terminal.	page A-50
0030	8020	Sets the ON/OFF status of all parallel terminals except for DO terminals.	page A-52
0030	8030	Sets the ON/OFF status of all parallel DO terminals.	page A-54
0030	A000	Sets the state of the operation log.	page A-57

● Commands to Read Data

First word in Response Area		Function	Reference
+3	+2		
0040	1000	Gets the specified processing unit data.	page A-58
0040	4050	Gets the conditions set for data logging.	page A-64
0040	4060	Gets the parallel DI terminal offset data that is set.	page A-64

● Commands to Write Data

First word in Response Area		Function	Reference
+3	+2		
0050	1000	Sets the specified unit data.	page A-65
0050	4050	Sets the data logging conditions.	page A-70
0050	4060	Sets the parallel DI terminal offset data.	page A-71

2-4-15 Command Response Processing

About control command response processing, the following timing chart describes the ON/OFF timing of signals related to commands to be input.

● Timing Chart for Command Execution

The Command Request (EXE) signal is used as the trigger to input and execute various commands such as measurement execution stored in advance in the external device (such as a PLC) memory.

The Command Completion (FLG) signal turns ON when execution of the control command is completed. Use this as the trigger to turn OFF the Command Request (EXE) signal.

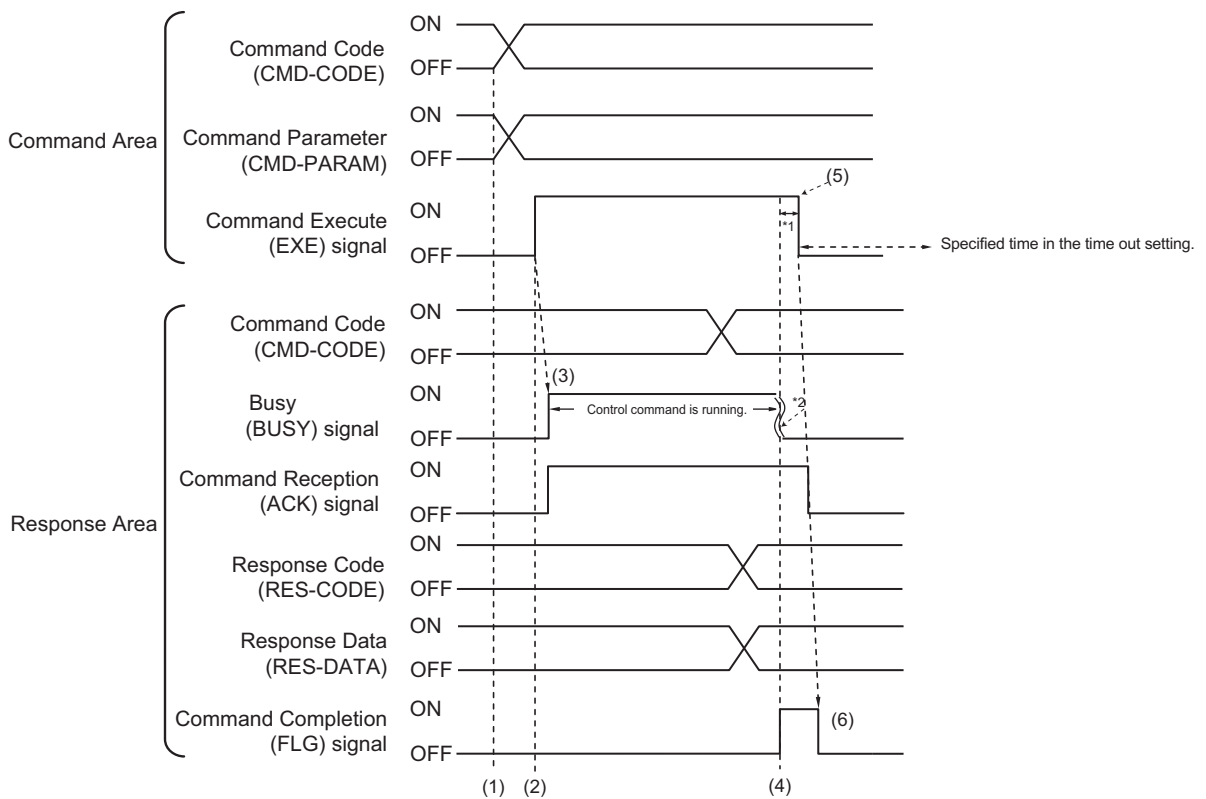

*1: A timeout error will occur if you do not turn off the Command Execution (EXE) signal within 10 seconds after the Command Completion (FLG) signal is turned ON.

Command Completion (FLG) signal and BUSY signal will be forcefully turned OFF.

*2: Busy (BUSY) signal is automatically switched ON to OFF when the command execution is completed.

- (1) The external device such as a PLC sets the command code and command parameters.
- (2) After checking that the BUSY signal and the Command Completion (FLG) signal have turned OFF, the PLC turns ON the Command Request (EXE) signal again to instruct the Sensor Controller to perform it.
- (3) When receiving the instruction the Sensor Controller performs the command and turns ON the ACK signal and the BUSY signal.
- (4) When completing the execution, the Sensor Controller sets the command code, response code, and response data.
The Command Completion (FLG) signal is turned ON.
- (5) The PLC (user) turns OFF the Command Request (EXE) signal when the Command Completion (FLG) signal turns ON.

- (6) When detecting that the Command Request (EXE) signal is OFF, the Sensor Controller automatically turns OFF the Command Reception (ACK) signal and the Command Completion (FLG) signal automatically.

● **Continuous Measurement Command (Without handshaking)**

Continuous execution is used to repeatedly execute measurement by starting the next measurement operation (image input and measurement processing) as soon as single measurement operation (image input and measurement processing) is completed. Continuous measurement is started when the Start Continuous Measurements command is executed and ended when the End Continuous Measurements command is executed.

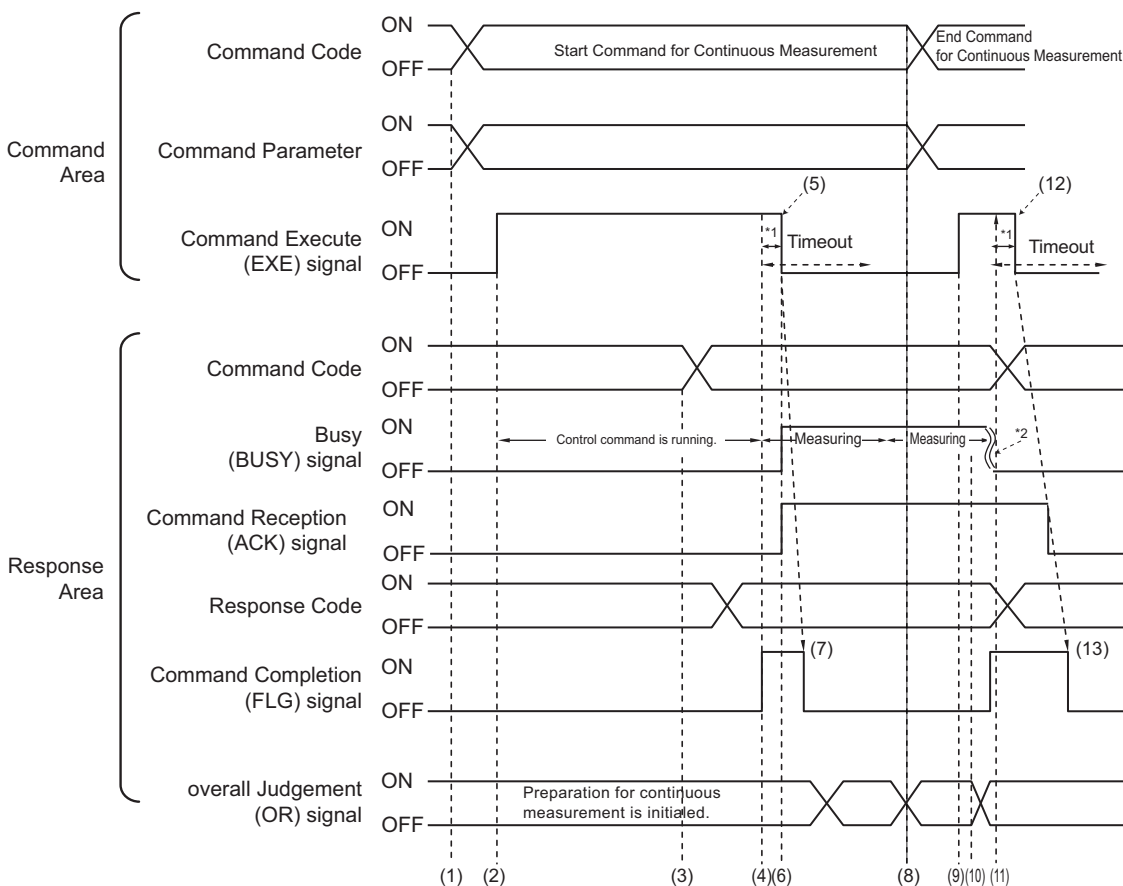

*1: A timeout error will occur if you do not turn off the Command Execution (EXE) signal within 10 seconds after the Command Completion (FLG) signal is turned ON. Command Completion (FLG) signal and BUSY signal will be forcefully turned OFF.
 *2: Busy (BUSY) signal is automatically switched ON to OFF when the command execution is completed.

<Operation to Start Continuous Measurements>

- (1) The PLC (user) sets the Start Continuous Measurements command code.
- (2) After checking that the BUSY signal and the Command Completion (FLG) signal have turned OFF, the PLC turns ON the Command Request (EXE) signal again to instruct the Sensor Controller to perform it.
- (3) When completing the preparations for continuous measurement, the Sensor Controller sets the command code and response code. when preparations for continuous measurement have been completed.
- (4) The Command Completion (FLG) signal is turned ON.
- (5) The PLC (user) turns OFF the Command Request (EXE) signal when the Command Completion (FLG) signal turns ON.

- (6) After detecting that the Command Request (EXE) signal has turned OFF, the Sensor Controller starts continuous measurement and turns ON the Command Reception (ACK) signal and the BUSY signal.
- (7) The Command Completion (FLG) signal is automatically turned OFF.

<Operation to End Continuous Measurement>

- (8) The PLC (user) sets the End Continuous Measurements command code during execution of continuous measurement by the Start Continuous Measurements command.
- (9) The Command Request (EXE) signal is then turned ON and the instruction is sent to the Sensor Controller.



Additional Information

Continuous measurement is not ended in the middle of measurement. When the End Continuous Measurements command was executed, continuous measurement is ended after the measurement in execution was completed.

<Ending Continuous Measurement>

- (10) When receiving the instruction, the Sensor Controller stops continuous measurement and turns OFF the BUSY signal.
- (11) After setting the command code and response code, the Sensor Controller turns ON the Command Completion (FLG) signal.
- (12) When detecting that the Command Completion (FLG) signal turns ON, the PLC (user) turns OFF the Command Request (EXE) signal.
- (13) After detecting that the Command Request (EXE) signal has turned OFF, the Sensor Controller automatically turns OFF Command Completion (FLG) signal.



Precautions for Correct Use

- The measurement during continuous measurement is given priority. Therefore, display of the measurement results (total judgment, images, judgment for each processing unit in the flow display, and detailed results) may sometimes not be updated.
- When continuous measurement is ended, the measurement results from the last measurement will be displayed.

● Performing Measurement with the STEP Signal

In addition to inputting and executing the Command Request (EXE) as a trigger, the Measurement Trigger Execute (STEP) signal can be used to perform measurement.

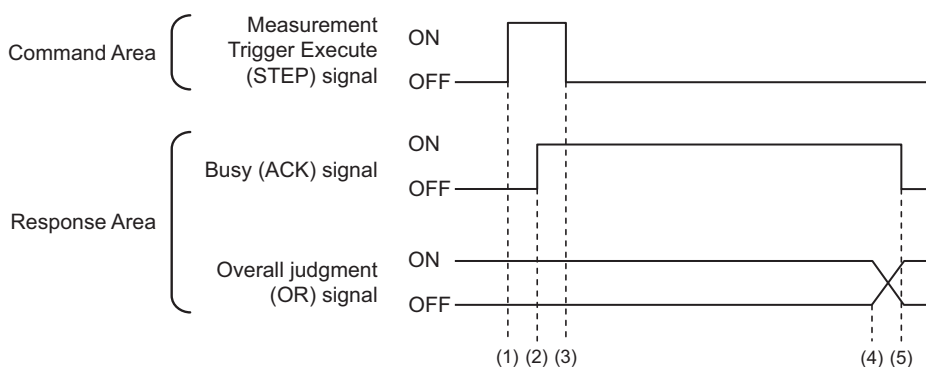

- (1) While the ACK signal is OFF, measurement starts by the rising edge of the Measurement Trigger Execute (STEP) signal.
- (2) The starting measurement turns ON the ACK signal.
- (3) The Measurement Trigger Execute (STEP) signal is turned OFF when the ACK signal turns ON.
- (4) The Overall Judgement (OR) signal is output when measurement is completed.
- (5) The ACK signal is turned OFF when the measurement flow is completed.

2-4-16 Data Output

This section describes the ON/OFF timing for signals related to measurement data output after measurement completion using the following timing chart.

● Without handshaking

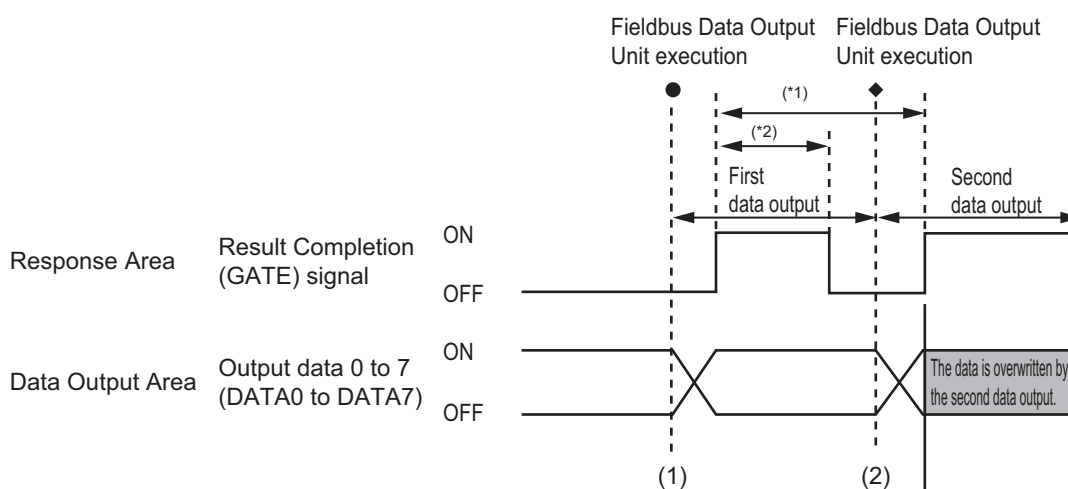

*1, *2: Data is output at the set output period^{*1} and for the set output time.^{*2}
After the data is output, the GATE signal is turned ON and the data is held for the data output time.

- (1) The Sensor Controller outputs data when the Fieldbus Data Output Unit starts execution.
- (2) Data is output each time that the Fieldbus Data Output Unit is performed for the second time or other Fieldbus Data Output Unit is performed. In that time, the output data for the first time is overwritten.



Precautions for Correct Use

- To receive all the output data, set *Output control* to *Handshaking*, and then output data. For details, refer to *Setting the PROFINET Output Specifications* on page 2-274, and *Output Format (Fieldbus Data Output)* on page 2-215)
- If any part of data is missing on the external device (such as a PLC) side, or the GATE signal is not output from the Sensor Controller of the FH series, set *Measurement priority* to *Lower the priority of the measurement process*. Note that the measurement time becomes longer with this setting. For details, refer to *Setting the Status at Startup [Startup Settings]* in the *Vision System FH/FHV Series User's Manual (Cat. No. Z365)*.

● With handshaking

The Result Completion (GATE) signal switches from OFF to ON when the PLC (user) switches the Result Set Request (DSA) signal from OFF to ON.

At that time, data that is possible to output will be output.^{*1}

The PLC (user) switches the DSA signal from ON to OFF under the conditions whether it has received the output data and the Result Completion (GATE) signal has been turned ON. In the case where multiple Fieldbus Data Output Units perform the data output, the PLC (user) turns the Data Output Request (DSA) signal ON again to instruct it to output the following data, when the Sensor Controller switched the Data Output Completion (GATE) signal from ON to OFF.

*1: Data prepared for output which an Output Unit has been already performed in the measurement flow.

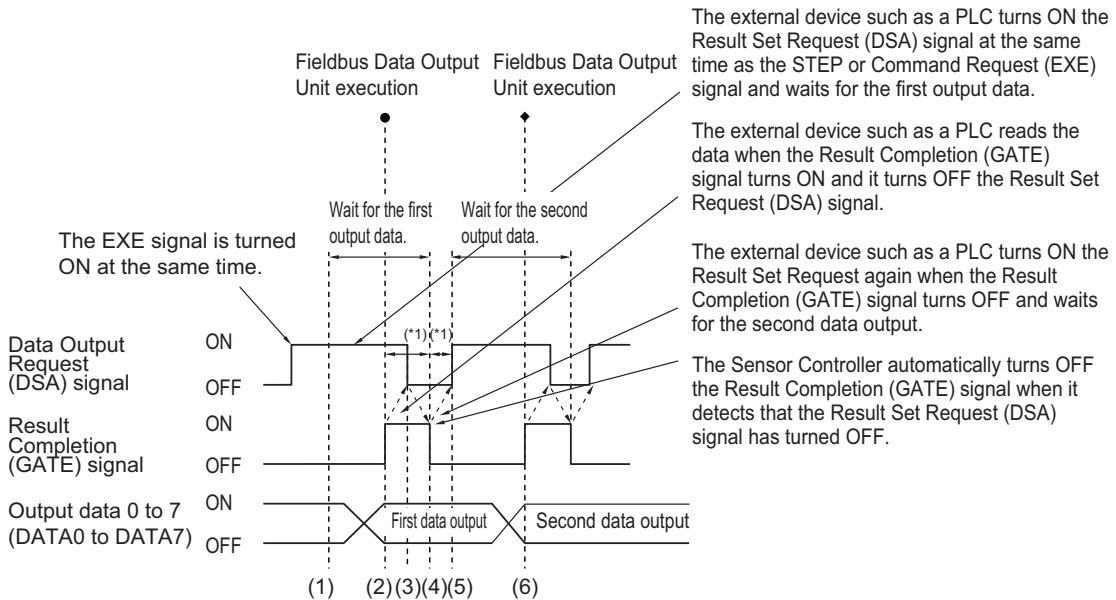

*1 A timeout error will occur if any of the following states continues for longer than the timeout time that is set in the EtherNet/IP settings.

- If the DSA signal is not turned ON after a certain time elapses from when the Output Unit was executed. (Turn ON the DSA signal at the same time as the measurement trigger command.)
- If the DSA signal is not turned OFF after a certain time elapses from when the GATE signal turns ON.

- (1) The PLC (user) turns ON the Command Request (EXE) signal and the Data Output Request (DSA) signal at the same time. The output data for the first Fieldbus Data Output Unit can be surely received.
- (2) The Sensor Controller performs the Fieldbus Data Output Unit in the measurement flow. Since the Data Output Request (DSA) signal is ON after the data is written, the Data Output Completion (GATE) signal becomes ON.
- (3) The PLC (user) reads the data when the Result Completion (GATE) signal turns ON and it turns OFF the Result Set Request (DSA) signal.
- (4) The Sensor Controller automatically turns OFF the Result Completion (GATE) signal when it detects that the Result Set Request (DSA) signal has turned OFF.
- (5) If there is more than one Fieldbus Data Output Unit in the measurement flow, the PLC (user) turns ON the Data Output Request (DSA) signal when the Data Output Completion (GATE) signal turns OFF, and then it waits for execution of the next Fieldbus Data Output Unit.
- (6) When the next Fieldbus Data Output Unit is executed, the GATE signal turns ON and the data is output. Receive the second output data and then repeat steps 3 to 5, above. Repeat steps 3 to 5 for any other data outputs.

2-4-17 Timing Chart

This section describes the ON/OFF timing for signals related to the sequence of operation from control command input until measurement data output after measurement completion using the following timing chart.

● Example 1: Inputting a Measurement Trigger after Switching a Scene without Handshaking

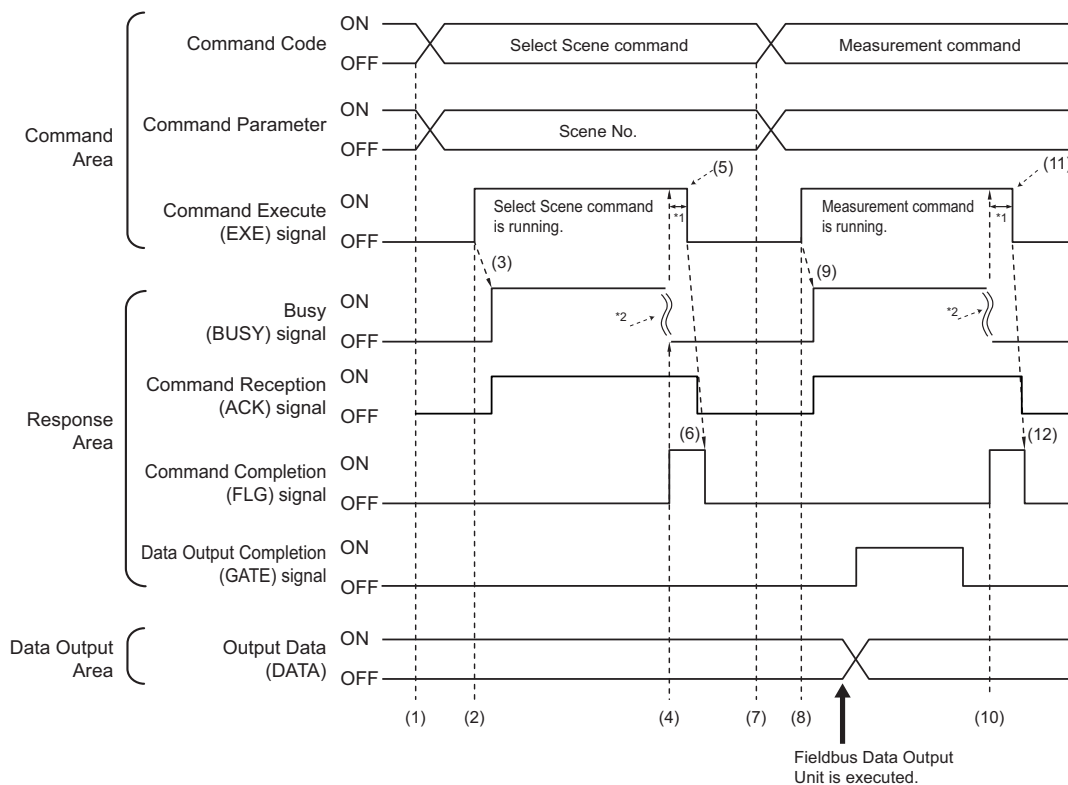

*1: A timeout error will occur if you do not turn off the Command Execution (EXE) signal from external device such as a PLC (master) within 10 seconds. Then Command Completion (FLG) signal and Busy (BUSY) signal will be forced to turn off.

*2: Busy (BUSY) signal is automatically switched ON to OFF when the command execution is completed.

- (1) The external device such as a PLC sets the command code and command parameters for the Switch Scene.
- (2) Next, confirm that the BUSY signal and the Command Completion (FLG) signal have turned OFF and then turn ON the Command Request (EXE) signal. A request is sent to the Sensor Controller.
- (3) The Sensor Controller turns ON the Command Reception (ACK) signal and BUSY signal and switches the scene when the request is received.
- (4) The Command Completion (FLG) signal is turned ON when the scene switching is completed.
- (5) The PLC (user) turns the Command Request (EXE) signal OFF when the Command Completion (FLG) signal is switched from OFF to ON.
- (6) After detecting that the Command Request (EXE) signal has turned OFF, the Sensor Controller automatically turns OFF the Command Reception (ACK) signal and Command Completion (FLG) signal.
- (7) The measurement command code and command parameters are set from the external device such as a PLC.
- (8) The Command Request (EXE) signal is turned ON to execute the measurement command.



Additional Information

To execute a measurement trigger after changing the scene, first confirm that the Command Completion (FLG) signal and the BUSY signal that turned ON for execution of the Select Scene command have turned OFF.

Also, if the BUSY signal is ON for too little time and the external device cannot read it, increase the time that the BUSY signal is ON for changing scenes so that the external device can read the ON state. To do this, change the *Add time* setting for the *Scene switch time*.

Refer to *Setting the Conditions That Are Related to Operation during Measurement* in the *Vision System FH/FHV Series User's Manual (Cat. No. Z365)*.

- (9) The Sensor Controller turns ON the Command Reception (ACK) signal and BUSY signal and performs measurement processing when the request is received.
- (10) The Command Completion (FLG) signal is turned ON when the measurement processing was completed.
- (11) The PLC (user) turns the Command Request (EXE) signal OFF when the Command Completion (FLG) signal turns ON.
- (12) When the Sensor Controller detects that the Command Request (EXE) signal is OFF, it automatically turns OFF the Command Reception (ACK) signal and Command Execution Completion (FLG) signal.

● Example 2: Outputting Data with more than One Output Unit Without Handshaking

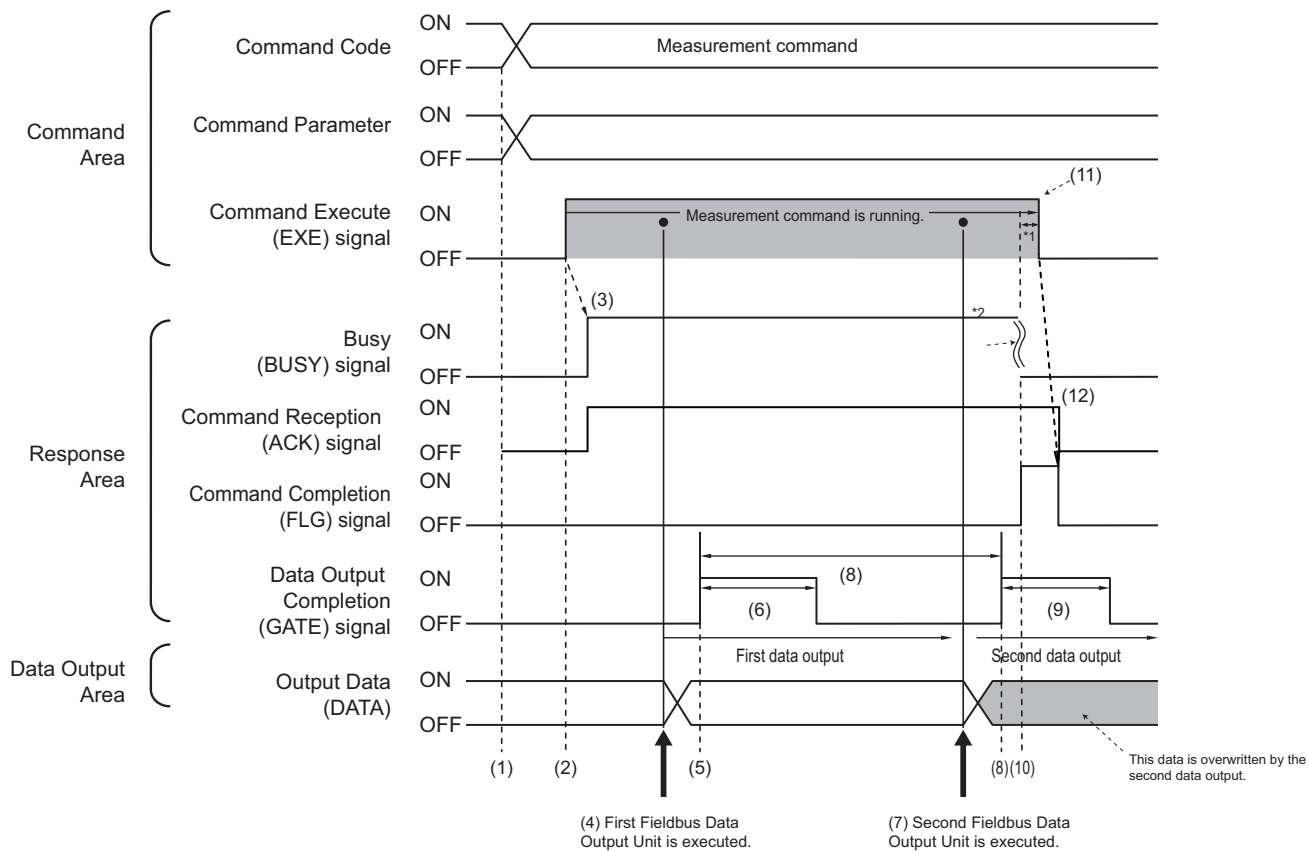

*1: A timeout error will occur if you do not turn off the Command Execution (EXE) signal from the external device such as a PLC (master) within 10 seconds. Then Command Completion (FLG) signal and Busy (BUSY) signal will be forced to turn off.

*2: Busy (BUSY) signal is automatically switched ON to OFF when the command execution is completed.

- (1) The measurement command code and command parameters are set from the external device such as a PLC.
- (2) Next, confirm that the BUSY signal and the Command Completion (FLG) signal have turned OFF and then turn ON the Command Request (EXE) signal. A request is sent to the Sensor Controller.
- (3) The Sensor Controller turns ON the BUSY signal and executes measurement processing when the request is received.
- (4) When the first Fieldbus Data Output Unit in the measurement flow is executed, the Sensor Controller outputs data for the first Fieldbus Data Output Unit to the Data Output Area.
- (5) The Sensor Controller turns the Data Output Completion (GATE) signal ON when the data is output to the Data Output Area.
- (6) The Sensor Controller turns the Data Output Completion (GATE) signal OFF after the time set at the **Output time** in the PROFINET settings has passed.
- (7) The second Fieldbus Data Output Unit in the measurement flow is executed.
- (8) The Sensor Controller outputs the data for the second Fieldbus Data Output Unit to the Data Output Area after the time set at the **Output period** in the PROFINET settings has passed. At that time, the data for the first Fieldbus Data Output Unit is overwritten.
- (9) The Sensor Controller turns the Data Output Completion (GATE) signal OFF after the time set at the **Output time** in the PROFINET settings has passed.
- (10) The Command Completion (FLG) signal is turned ON when the measurement processing was completed.
- (11) The PLC (user) turns the Command Request (EXE) signal OFF when the Command Completion (FLG) signal turns ON.
- (12) When the Sensor Controller detects that the Command Request (EXE) signal is OFF, it automatically turns OFF the Command Reception (ACK) signal and Command Execution Completion (FLG) signal.



Additional Information

Saving All of the Measurement Results

If you output data from more than one Data Output Unit or for repeatedly measured output data (e.g., for continuous measurements), the same Data Output Area will be overwritten.

To save all of the output data, adjust the *Output period* and *Output time* that are set in the EtherCAT settings so that all of the output data is output and either receive all of the output data by using the Result Notification signal or use handshaking control.

Handshaking lets you control data output by using the Result Notification signal turning ON as a trigger for the data output timing and turning ON the Result Set Request to read the output data.

Each time that data is output (from the second output on), read the output data and move it to a different part of I/O memory in the external device such as a PLC.

For more information on handshaking, refer to *Data Output Control with Handshaking* on page 1-24.

You can compare the received number of output data and the number of measurements for continuous measurements to check if all of the measurement results have been received.

Use the following method to check the number of measurements that was actually executed.

- Application Example

Set a calculation to count the number of measurements that are executed in the measurement flow.

If you set something like [DO+1], each time a measurement is executed (each time the measurement flow is executed), 1 will be added to DO, so the present value of DO will give you the actual number of measurements.

2-4-18 PROFINET Troubleshooting

Cannot Connect with the Sensor Controller

Problem	Cause	Action
Cannot establish the IO link with the Sensor Controller.	The GSD file version is different from the firmware one.	Make sure that the EDS file version matches the firmware version.
In OMRON PROFINET interface unit, the IO data settings cannot be transferred to the unit.	The total of the output data size exceeds the maximum size capable of outputting in Multi-line Random-trigger mode.	Adjust the output data size so that the total size is within 416 bytes.

No Data is Output from the Sensor Controller

Problem	Cause	Action
The GATE signal is not output.	The relationship between the <i>Update Rate</i> of the IO controller and the <i>Output time</i> and <i>Output period</i> for the Sensor Controller is improper.	Decrease the value set at the <i>Update Rate</i> of the IO controller or increase the values set at the <i>Output time</i> and <i>Output period</i> for the Sensor Controller.
No data is output at all.	The communication module is set incorrectly.	Check that PROFINET is set in the communication module settings.
	The output data size (Data Format) of the Sub-module in the IO controller is different from that of the Sensor Controller.	Match the both output data size (Data Format).

A Timeout Error Occurred

Problem	Cause	Action
A handshaking timeout error occurred.	<p>The timing to switch the DSA signal is too slow.</p> <p>The following patterns are considered.</p> <ul style="list-style-type: none"> The DSA signal is not turned ON even after measurement has been completed. The DSA signal is not switched from ON to OFF even after the GATE signal has been turned ON. The DSA signal is not turned ON even after the GATE signal has been turned OFF. 	<p>After the measurement command is performed, turn the Data Output Request (DSA) signal ON and OFF within the timeout time set in the PROFINET communication settings.</p> <p>Or, increase the <i>Timeout time</i> set in the PROFINET settings.</p>

Problem	Cause	Action
A timeout error for the IO controller occurred and the connection was disconnected.	The watchdog in the IO controller operated and a timeout error occurred. The Sensor Controller prioritizes measurement processing and control processing over communication processing. Therefore, as the result of the communication processing delayed due to the heavy loads of the internal processing, communications between an external device and the Sensor Controller may be temporarily interrupted and a communication error may occur.	Increase the value set at the Update Rate of the IO controller or make the value for <i>Watchdog Factor</i> and <i>Data Hold Factor</i> to large respectively.

Slow Operation

Problem	Cause	Action
Response and data output is slow.	You try to use a wrong combination for communication protocols, like a combination of PLC Link and PROFINET.	Use a proper combination of communication protocols.

Settings are not kept

Problem	Cause	Action
Settings such as Fieldbus Data Output calculations and comments are not kept.	Changed the communication settings after setting the Fieldbus Data Output.	Set the Fieldbus Data Output after performing the communication module settings.

Communications between the Sensor Controller and External Devices are not Correctly Done.

Problem	Cause	Action
The Sensor Controller cannot communicate with an external device such as a PLC properly. (Only for Ethernet)	The communication settings such as IP address have been changed after the Device information storage tool was performed. (The IP addresses for external devices on the network may have overlapped the IP addresses stored in the Sensor Controller.)	Check that the communication settings such as IP address are correct. (Tool menu - System setting - Communication - Ethernet) Perform the Device information storage tool again. The communication settings in the software will be copied in the Sensor Controller.

Missing of data Occurs

Problem	Cause	Action
Missing of data occurs. Data Output Completion (GATE) signal and BUSY signal are not output from the Sensor Controller.	Since the measurement load on the Sensor Controller becomes heavy, the communication processing for EtherNet/IP is delayed.	Setting <i>Measurement priority</i> to <i>Lower the priority of the measurement process</i> can ease up. Note that the measurement time will delay. For details, refer to Setting the Status at Startup <i>Startup Settings</i> in the <i>Vision System FH/FHV Series User's Manual (Cat. No. Z365)</i>

2-5 Non-procedure Communications

This section provides the communications settings, communications specifications, input formats, and other information required to perform Non-procedure (normal) communications between the Sensor Controller and an external device.

2-5-1 Communications Processing Flow

The Sensor Controller communicates with an external device using command-based Non-procedure communications via Ethernet or RS-232C.

In Ethernet, UDP/IP or TCP/IP protocol is used for the communications.

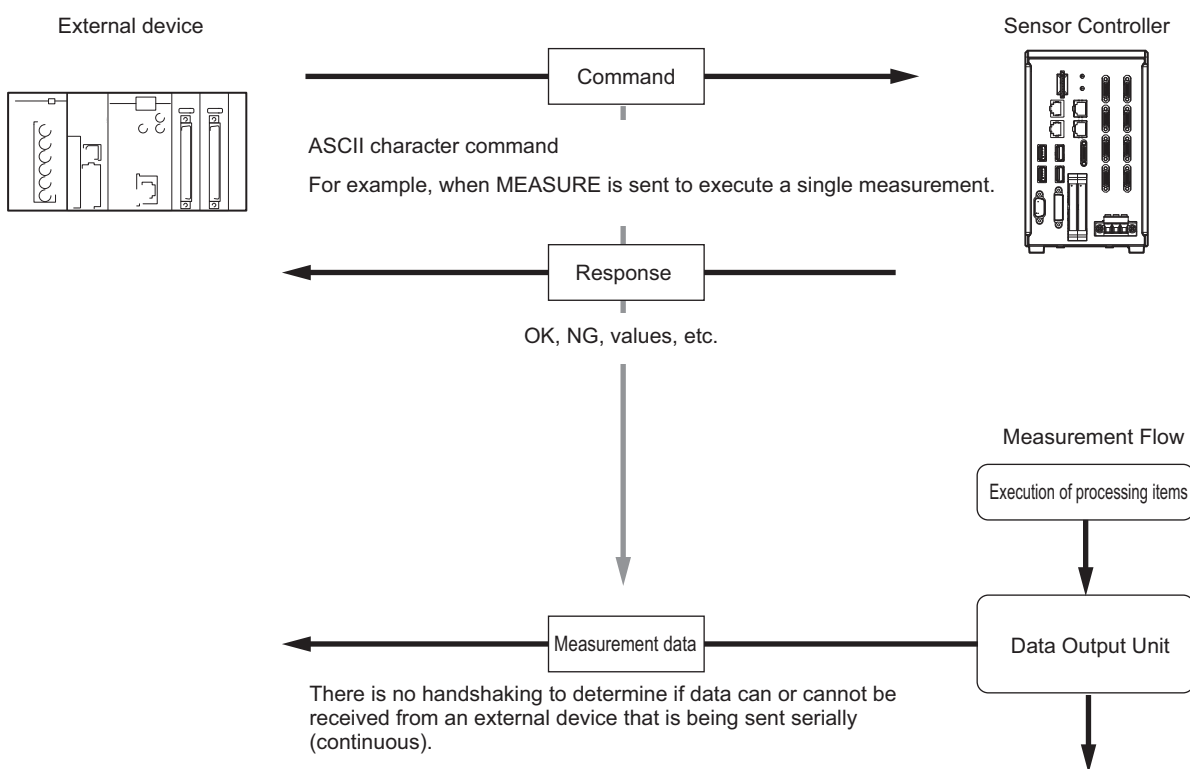

*1 : If *Xon/Xoff* is selected for the *flow control* and no response is received from the computer within the set timeout interval, there must either be a disconnection or the computer is not functioning correctly, causing the communications to time out.

2-5-2 Communications Setup Procedures

The following settings are required to use Non-procedure.

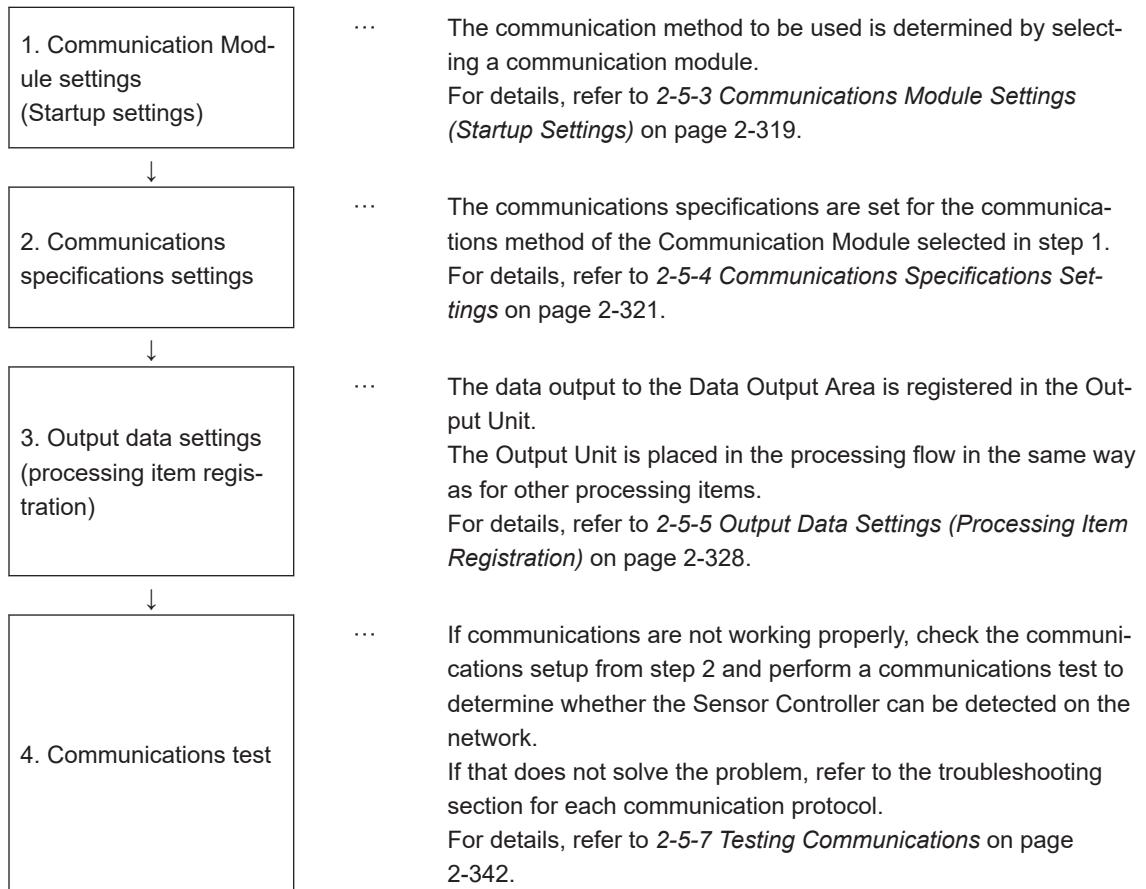

2-5-3 Communications Module Settings (Startup Settings)

The communication method used for communication with the Sensor Controller is selected from the communication modules.

- 1 On the Main window, click **Tool - System Settings** to open the system settings.
- 2 On the Multiview Explorer on the left, select **System settings - Startup - Startup setting** and then click the **Communication** tab.

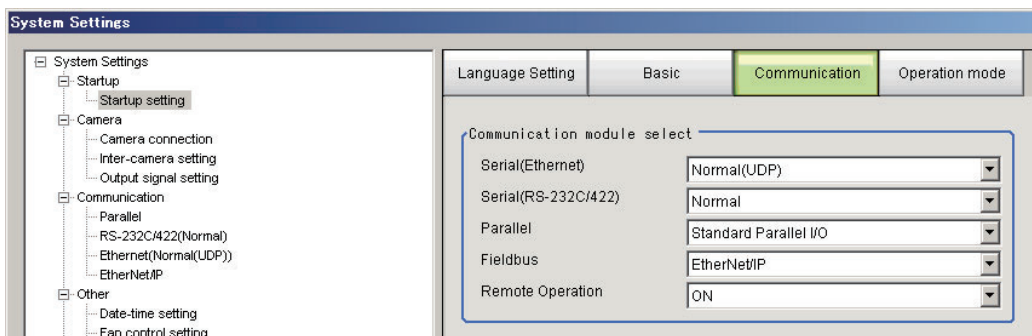

- 3 Select one of the following Communication Modules based on the communication method used to connect with the Sensor Controller and the Unit to be connected, and then click **Apply**.

Communications Module	Description
Serial (Ethernet)	Performs Non-procedurecommunications through an Ethernet connection.
Non-procedure (UDP)	Select this Communication Module to communicate with the external device using UDP communications.
Non-procedure (TCP)	Select this Communication Module to communicate with the external device using TCP server communications.
Non-procedure (TCP Client)	Select this Communication Module to communicate with the external device as a TCP client.
Non-procedure (UDP) (Fxxx series method)	Select this Communication Module to communicate with the external device through UDP or Fxxx series*1 communications.
Serial (RS-232C/422)	Normally select this Communication Module to use Non-procedure communications through an RS-232C/422 connection. *2
Non-procedure	Normally selected.
Non-procedure (Fxxx series method)	Select this Communication Module to communicate with the external device through Fxxx series*1 communications.

*1. With the [Normal (Fxxx series method)] communications method, the OK response timing in relation to MEASURE commands is different from that of the [Normal] communications method. For details, refer to 2-5-9 *Command Formats* on page 2-347.

*2. RS-422 is unavailable in the FH/FHV series.

- 4 Click **Data save** in the Toolbox Pane.

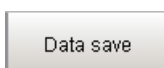

- 5** On the Main window, click **Function - System restart**.
- 6** Click **OK** in the System restart dialog box to restart the Sensor Controller.
When the Sensor Controller was restarted, the set Communication Module will operate with the default settings.
- 7** Set the IP address and other parameters for external devices such as a PLC.



Precautions for Correct Use

After you set the Communication Module, always click **Data save** and then restart the Sensor Controller. If the settings are not saved and the Sensor Controller is not restarted, the new Communication Module settings will not be enabled



Additional Information

You can save the Communication Module settings to a file.
Use the *System data* or *System + Scene group 0 data* option for *saving settings to a file*.
For details, Refer to *Saving Settings Data to the Controller RAM Disk or an External Storage Device* in the *Vision System FH/FHV Series User's Manual (Cat. No. Z365)*.

2-5-4 Communications Specifications Settings

The communications settings must be set separately for Ethernet and RS-232C communications. If communications cannot be performed even after setting these communications settings, check the settings and the communications status.

For details, refer to *2-5-7 Testing Communications* on page 2-342.



Precautions for Correct Use

- The settings dialog box for the communication specifications will change depending on the Communication Module that you use.
Before you set the communication specifications, select the Communication Module to use with the Sensor Controller in the startup settings.
For details, refer to *2-5-3 Communications Module Settings (Startup Settings)* on page 2-319. After you selected the Communication Module, save the settings to the Sensor Controller and restart it.
If you do not restart the Sensor Controller, the selected Communication Module will not be enabled.
- Use the same communication settings for the Sensor Controller and the external device.
- Do not input signals to Ethernet from an external device while setting the Ethernet system settings.
- If the operation mode is set to *Multi-line Random-trigger Mode*, the Controller address cannot be set for line 1 onward. (The same setting for line 0 is used.)

Connecting via Ethernet

- 1** On the Main window, click **Tool - System Settings** to open the system settings.
- 2** In the tree view on the left, select **System Settings - Communication - Ethernet Normal (xyz)** ("xyz" depends on the Communication Module).
The Ethernet view is displayed.
- 3** Set each item.
 - UDP case

Address setting

Obtain an IP address automatically

Use the following IP address

IP address:

Subnet mask:

Default gateway:

DNS server:

Preferred WINS server:

Alternate WINS server:

Address setting 2

Obtain an IP address automatically

Use the following IP address

IP address:

Subnet mask:

Default gateway:

DNS server:

Preferred WINS server:

Alternate WINS server:

Input/Output setting

Input mode: Normal

Input form: ASCII

Output IP address:

Input port No.:

Output port No.: (-1: Same number Input port No)



Additional Information

- Sensor Controllers of the FH-2000 / FH-5000 series have two Ethernet ports. Set the settings for the two Ethernet ports as follows:
 - Communication Module Settings:
Use the same settings for both ports
 - IP Address Setting:
Set a different IP address for each Ethernet port.
The IP address for the top Ethernet port is set in *Address setting*, and the IP address for the bottom Ethernet port is set in *Address setting 2*. Note that the Sensor Controller prioritizes the bottom port, so when there is a high network load, communication on the top port may be delayed or in some cases communication data may be lost. By using both Ethernet ports simultaneously, you can use the bottom port for PLC Link, Non-procedure, EtherNet/IP, or PROFINET communications with an external device such as a PLC and the top port for FTP or remote operation communications with an external device.
- The following Sensor Controller type has one Ethernet port:
 - FH-L/FHV series
In this case, the IP address of the Ethernet port is set in *Address setting 2*

Setting item	Setting value [Factory default]	Description
Address Settings Address Settings is only for the following series: FH-2000 / FH-5000 series		Set the IP address for the upper Ethernet port on the Sensor Controller.

Setting item	Setting value [Factory default]	Description
	<ul style="list-style-type: none"> Obtain an IP address automatically. [Use the following IP address] 	Set the IP address for the Sensor Controller. When <i>Obtain an IP address automatically</i> is selected, the IP address of the Sensor Controller will be automatically obtained. When <i>Use the following IP address</i> is selected, set the IP address, subnet mask, and the default gateway address.
IP Address	a.b.c.d a: 1 to 223 b: 0 to 255 c: 0 to 255 d: 0 to 254 [10.5.5.100]	Enter the IP address for the Sensor Controller.
Subnet mask	0.0.0.0 to 255.255.255.255 [255.255.255.0]	Enter the subnet mask address.
Default gateway	a.b.c.d a: 1 to 223 b: 0 to 255 c: 0 to 255 d: 0 to 255 [10.5.5.100]	Enter the default gateway address.
DNS server	a.b.c.d a: 1 to 223 b: 0 to 255 c: 0 to 255 d: 0 to 255 [10.5.5.100]	Enter the DNS server address.
Preferred WINS server	a.b.c.d a: 1 to 223 b: 0 to 255 c: 0 to 255 d: 0 to 255 [0.0.0.0]	Enter the WINS server address.
Alternate WINS server	a.b.c.d a: 1 to 223 b: 0 to 255 c: 0 to 255 d: 0 to 255 [0.0.0.0]	Enter the WINS server address.

Setting item	Setting value [Factory default]	Description
Address Settings 2		
Address Settings 2	Address Settings is only for the following series: FH-2000 / FH-5000 / FH-L / FHV series	Set the IP address for the lower Ethernet port on the Sensor Controller.

Setting item	Setting value [Factory default]	Description
	<ul style="list-style-type: none"> Obtain an IP address automatically. [Use the following IP address] 	Same as "Address Settings".
IP Address	a.b.c.d a: 1 to 223 b: 0 to 255 c: 0 to 255 d: 0 to 254 [10.5.6.100]	
Subnet mask	0.0.0.0 to 255.255.255.255 [255.255.255.0]	
Default gateway	a.b.c.d a: 1 to 223 b: 0 to 255 c: 0 to 255 d: 0 to 255 [10.5.6.100]	
DNS server	a.b.c.d a: 1 to 223 b: 0 to 255 c: 0 to 255 d: 0 to 255 [10.5.6.100]	
Preferred WINS server	a.b.c.d a: 1 to 223 b: 0 to 255 c: 0 to 255 d: 0 to 255 [0.0.0.0]	Enter the WINS server address.
Alternate WINS server	a.b.c.d a: 1 to 223 b: 0 to 255 c: 0 to 255 d: 0 to 255 [0.0.0.0]	Enter the WINS server address.

Setting item	Setting value [Factory default]	Description
--------------	------------------------------------	-------------

Input and Output settings

Output IP Address/TCP Server*1	a.b.c.d a: 1 to 223 b: 0 to 255 c: 0 to 255 d: 0 to 254 [0.0.0.0] / [10.5.5.101]*1	Enter the IP address for the output destination.
--------------------------------	--	--

Setting item	Setting value [Factory default]	Description
Input/Output port No.	0 to 65,535 ^{*2} [9,600] / [9,876] ^{*3}	Set the port number to use for the data input and output with the Sensor Controller.

- *1. When the TCP is used for the connection, *TCP Server* is displayed. Factory default settings are [10.5.5.101].
- *2. When the UDP is used for the connection, do not set the port numbers from "9,700" to "9,700 + line number".
- *3. When the TCP is used for the connection, Factory default settings are [9,876].

- 4** Click **Apply** to finish the settings.
Click **Close** to close the System Settings dialog.



Precautions for Correct Use

- If the operation mode is set to **Multi-line Random-trigger Mode**, set a different I/O port number for each line.
- Change the IP address and subnet mask for **Address setting** and **Address setting 2** as required so that each designate a different network address. If the same network address were specified, communications may not be performed correctly.
- Be sure to change the output IP address from its factory default value in accordance with your network environment.

Connecting via RS-232C



Additional Information

- Input signals cannot be handled during setting of communications specifications. However, the input status can be checked with **Confirmation**.
For details, refer to *2-5-7 Testing Communications* on page 2-342.
- Data output via serial communications is suspended while communications specifications are being set.

- 1** On the Main window, click **Tool - System Settings** to open the system settings.
- 2** From the tree view on the left, select **System Settings** and then select **Communication -RS-232C/422 (Normal)** or **RS-232C/422 (Normal (Fxxx series method))**
The RS-232C window is displayed.
- 3** Set each item..

Setting	Confirmation
Mode :	Normal
Interface :	RS-232C
Baud rate [bps] :	38400
Data length [bit] :	8
Parity :	None
Stop bit [bit] :	1
Flow control :	None
Delimiter :	CR
Timeout [s] :	5 ...

Setting item	Set value [Factory default]	Description
Interface	<ul style="list-style-type: none"> • [RS-232C] • RS-422*1 	Align the communication specifications with the external device.
Baud rate [bps]*2	<ul style="list-style-type: none"> • 2,400 • 4,800 • 9,600 • 19,200 • [38,400] • 57,600 • 115,200 	Align the communication specifications with the external device.
Data length [bit]	<ul style="list-style-type: none"> • 7 • [8] 	Align the communication specifications with the external device.
parity	<ul style="list-style-type: none"> • [None] • Odd • Even 	
Stop bit [bit]	<ul style="list-style-type: none"> • [1] • 2 	
Flow control	<ul style="list-style-type: none"> • [None] • Xon/Xoff 	<p>None: The software does not perform the flow control. If the time in which there is no response from external devices reaches the timeout setting time, a timeout error occurs and an error message is displayed in the window. Moreover, the parallel interface ERROR signal turns ON.</p> <p>Xon/Xoff: The software performs the flow control. Data is transmitted according to the Xon/Xoff codes from external devices.</p>
Timeout [s]	<ul style="list-style-type: none"> • 1 to 120 [5] 	Set the time in which a timeout error will occur.

Setting item	Set value [Factory default]	Description
Delimiter	<ul style="list-style-type: none"> • [CR] • LF • CR+LF 	Align the communication specifications with the external device.

*1. RS-422 cannot be used with the FH/FHV-series.

*2. If a baud rate of **38,400bps** or higher is selected, effective communications may not be possible depending on the cable length because speeds of over 20 Kbps are not defined in RS-232C standards. In this case, set the baud rate to **19,200bps** or lower.

4 Click **Apply** to finish the settings.

5 Click **Close** to close the System Settings dialog box.

2-5-5 Output Data Settings (Processing Item Registration)

Use the following procedures to set the items to output and the output format for the non-procedure protocol.

This processing item is not available in the FHV series. When you set output data in the FHV series, refer to *2-5-6 Output Data Settings (Numerical Values/Character Strings)* on page 2-334.



Additional Information

When outputting characters read by a processing item such as Barcode, these settings are set in the processing item used to read the characters (Character Inspection, Barcode, or 2DCode). Refer to the descriptions for each processing item for details on the character output settings and output format. (Reference Manual (Cat. No. Z341).)

- *Character Inspection*
Refer to *Character Inspection* in the *Vision System FH/FHV Series Processing Items*
- Barcode
Refer to *Barcode* in the *Vision System FH/FHV Series Processing Items*
- 2DCode
Refer to *2DCode* in the *Vision System FH/FHV Series Processing Items*
- OCR
Refer to *OCR* in the *Vision System FH/FHV Series Processing Items*

Registering Processing Items

Register the processing items for data output in the measurement flow.

- 1 Select the **Data Output** processing item in the processing item tree.

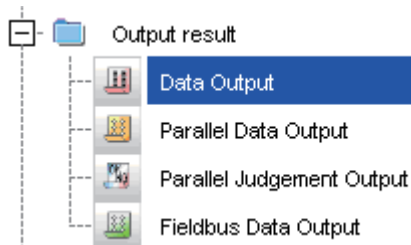

- 2 Click **Append**.

The **Data Output** processing item is added at the bottom of the unit list (flow).

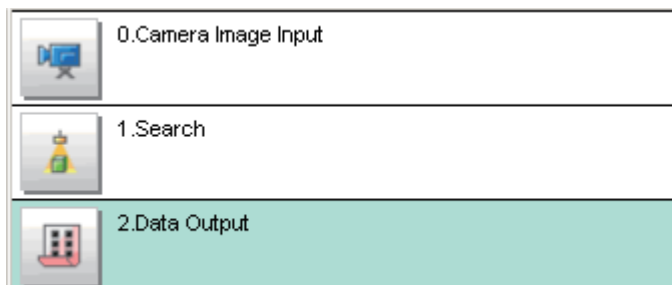

- 3 Click *Data Output*  icon and set the data output items and data format.

For details of the settings, refer to the following.

Registering the Items To Output on page 2-329



Additional Information

Data is output in the order that data output is registered in the measurement flow, i.e., the timing is different for each data output processing item. (Data output is executed in the order that it is executed in the measurement flow.)

For details, refer to *Outputting the Measurement Data* on page 1-18

Registering the Items To Output

Set the output data with expressions.

Up to 8 expressions from 0 to 7 can be set in each unit.

1 Click

- 1 Click Data Output  icon in the measurement unit list (flow).
- 2 In the Item tab area, click **Setting**.
- 3 In the list, click the output data number to set the expression.

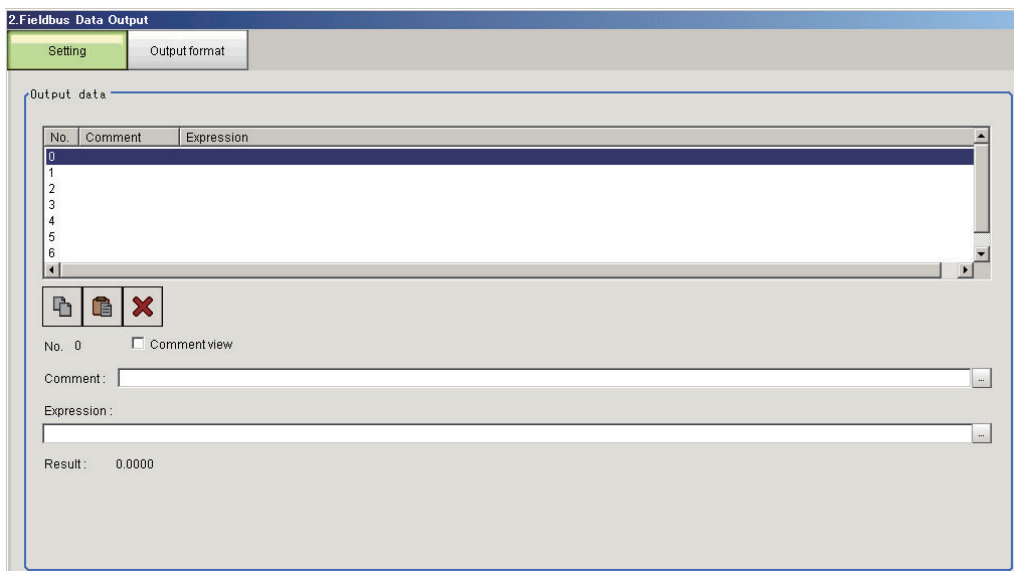

The selected output data number is displayed under the list.

- 4 Click  next to the expression text box and set the expression.



Specify the processing items, measurement results, and measurement data in the expression. Arithmetic or function calculations can be applied to the measurement data to output.

For details of the calculation settings, refer to *Calculation* in the *Vision System FH/FHV Series Processing Items Reference Manual (Cat. No. Z341)*.

- 5 Click  for the **Comment** text box and enter the description for the expression. The entered comment will be displayed in the detailed results area on the Main window. For example, *Test* was entered as the comment for the expression 0, *Test* will be displayed instead of *Expression 0* in the detailed results areas on the Main window.

- Repeat step 3 to 5 to set expressions for all of the required output data numbers.



Additional Information

If you delete one of the expressions that is set for output data 0 through 7, the output numbers for all expressions after the deleted expression will stay the same. However, the actual data output will be output as though the list has been shifted forward for the number of expressions that have been deleted.

Example: If the Expression for Output 1 Is Deleted

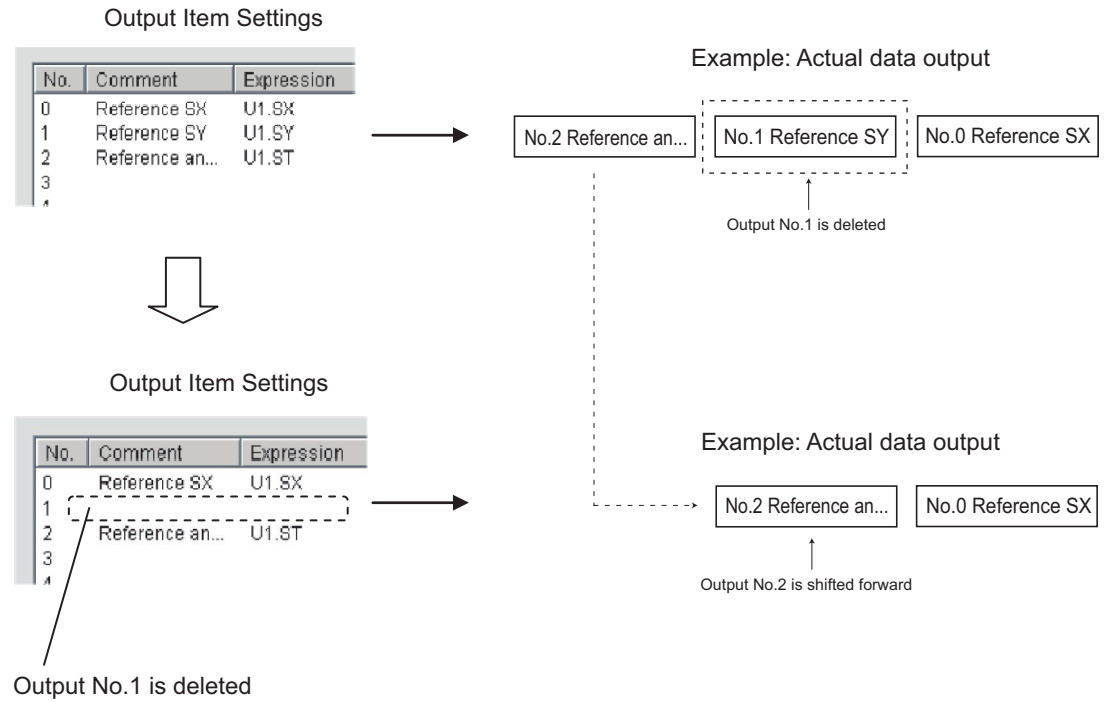

Output Format (Data Output)

- Click Data Output icon in the measurement unit list (flow).
- In the item tab area, click **Output format**.
- In the Output Setting Area, select the communication method.

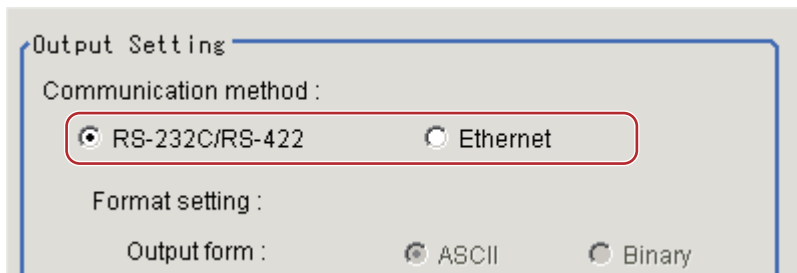

Setting item	Setting value [Factory default]	Description
Communication method	[RS-232C/RS-422]	Communications are performed via the RS-232C/RS-422 connection. *1
	Ethernet	Communications are performed via the Ethernet connection.

*1. RS-422 is unavailable in the MELSEC Q series and the FH/FHV series.

4 Select the output format in **Format setting**.

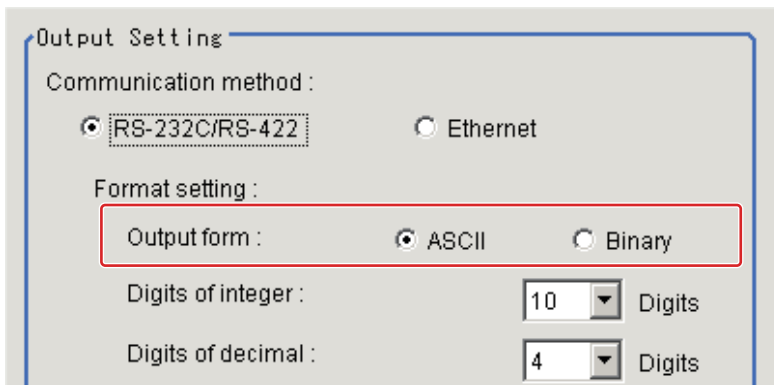

Setting item	Setting value [Factory default]	Description
Output format	[ASCII]	Outputs ASCII text. For details, refer to <i>Character Code Table</i> in the <i>Vision System FH/FHV Series User's Manual (Cat. No. Z365)</i> .
	Binary	Outputs binary data. Measurement values are multiplied by 1,000 and output is continuous with 4 bytes per data item.

• **When the ASCII Output Format Is Selected**

When *ASCII* is set as the output format, set the following format settings.

When *Binary* is set as the output format, no settings are needed.

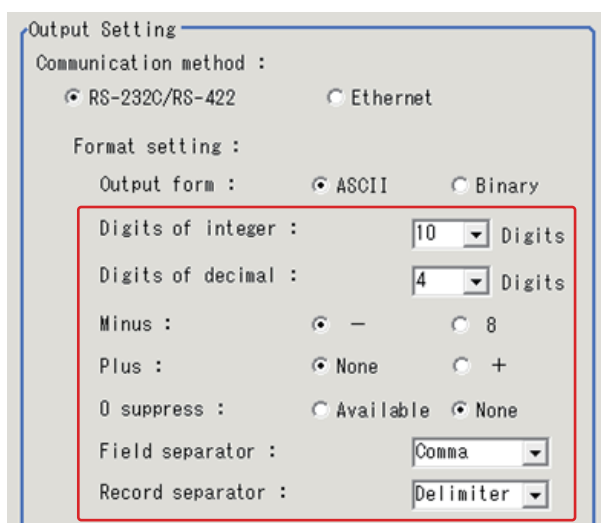

Setting item	Setting value [Factory default]	Description
Digits of integer	1 to 10 [10]	Specify the digits of the integer part including the sign. For positive numbers, the plus sign is not output. Example: Setting: 4 digits, Data: -5619 "-999" will be output.
Digits of decimal	0 to 4 [4]	Specify the number of output digits in the decimal part. Lower decimal digits are rounded up before the data is output. When 0 is selected, the decimal digits will be rounded off.
Minus	<ul style="list-style-type: none"> • [-] • 8 	Select what is displayed in the sign digit for a negative number.
Plus	<ul style="list-style-type: none"> • [None] • + 	Select what is displayed in the sign digit for a positive number.
0 suppress	<ul style="list-style-type: none"> • Available • [OFF] 	Select the method for adjusting when there is a blank to the left of the output data. <ul style="list-style-type: none"> • Available: Insert 0 into the blank digits. • OFF: Insert a space for unused character. Example: If the integer section is set to 5 digits and the decimal section is set to 3 digits, the data is 100.000 Available: 00100.000 OFF: _100.000 ("_" represents a space.)
Field separator	<ul style="list-style-type: none"> • OFF • [Comma] • Tab • Space • Delimiter 	Select the separator for output data. (The delimiter is obtained from the system.)
Record separator	<ul style="list-style-type: none"> • OFF • Comma • Tab • Space • [Delimiter] 	Select the separator for each time data is output. (The delimiter is obtained from the system.)

5 If you selected *Ethernet* for the **Communication method**, perform the Ethernet settings.

Output Setting

Communication method :
 RS-232C/RS-422 Ethernet

Format setting :
 Output form : ASCII Binary

Digits of integer : Digits

Digits of decimal : Digits

Minus : - 8

Plus : None +

0 suppress : Available None

Field separator :

Record separator :

Output IP address setting :
 Refer System (Ethernet)
 The following IP address

Output IP address :

Setting item	Setting value [Factory default]	Description
Output IP address setting	[Refer System (Ethernet)]	The settings of the Ethernet View are applied. One of the following Ethernet Views is used to make the settings. <ul style="list-style-type: none"> • PLC Link Communications Settings refer to 2-2-4 <i>Communication Specifications Settings</i> on page 2-133. • Ethernet Non-procedure Communications Settings Refer to 2-5-4 <i>Communications Specifications Settings</i> on page 2-321/
	The following IP address Output IP addresses	Enter the output IP address.

2-5-6 Output Data Settings (Numerical Values/Character Strings)

Registering Processing Items

Register the processing items for data output in the measurement flow.

- 1 In the Main window, click **Edit flow** in the Toolbox Pane.
- 2 Select **Result output (Message)** from the processing item tree.

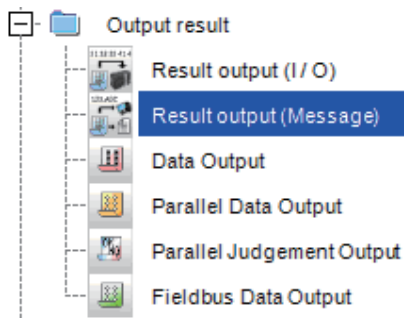

- 3 Click **Append**.
The **Result output (Message)** is appended at the bottom of the unit list (flow).

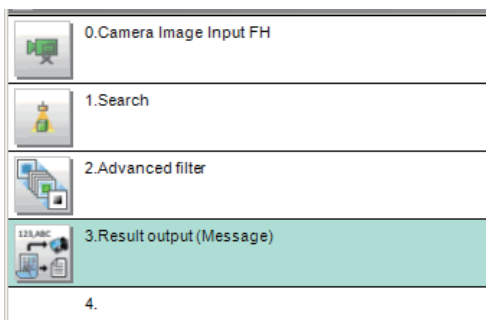

- 4 Click the icon  of **Result output (Message)** in the unit list (flow) or **Set** to set the output device and the output data.

Setting the Output Device

Here, set a communication method when data is output.

- 1 Click the icon  of **Result output (Message)** in the unit list (flow) or **Set** to set the output device.
The **Result output (Message)** setting window is displayed.

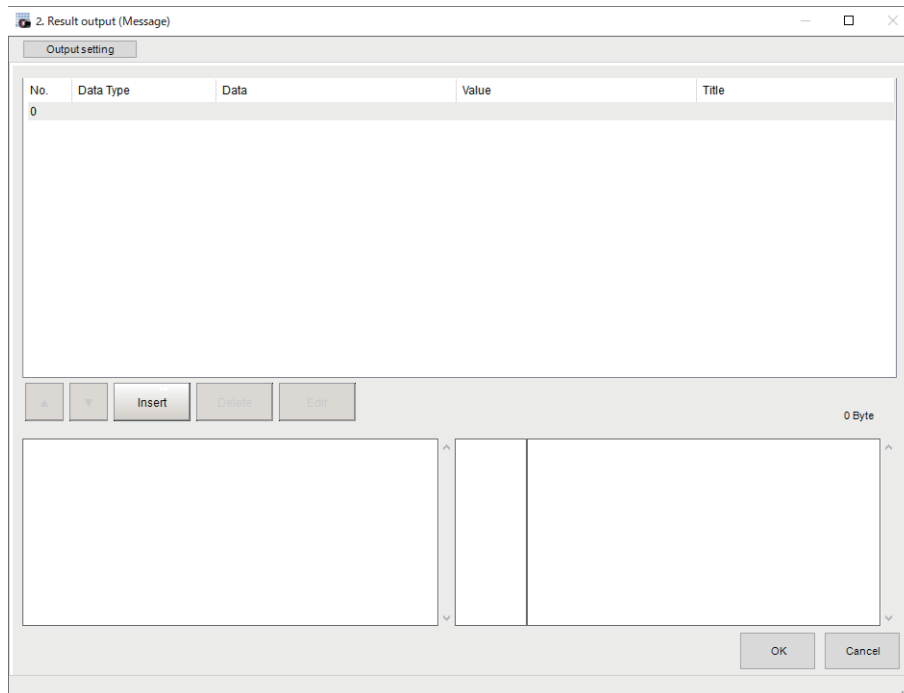

- 2** Click **Output setting**.
The **Output setting** window is displayed.

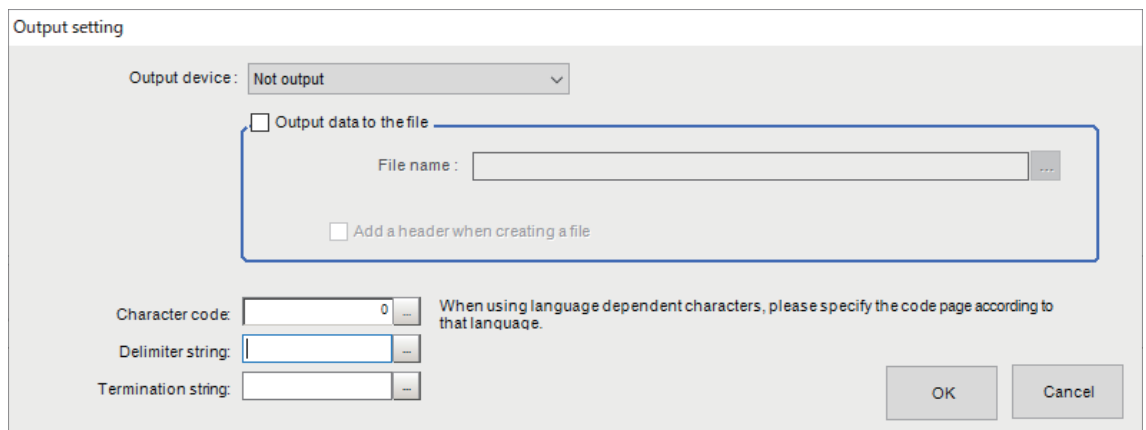

- 3** Click at the right side of the **Output device** text box to select "Serial(Ethernet)" or "Serial(RS-232C/422)" to use.

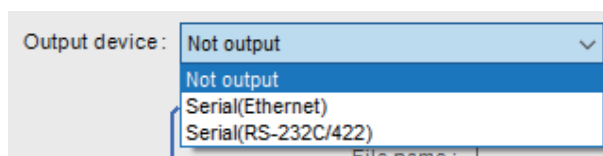

- 4** Select whether or not to output data to a file (data logging).

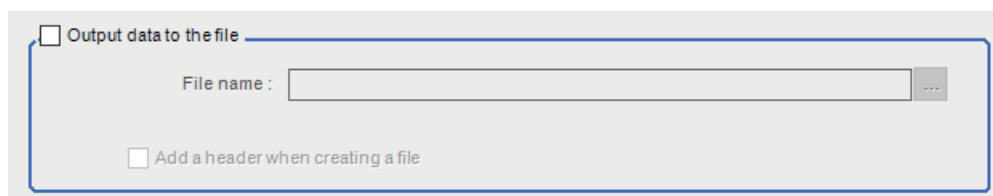

Check the box for *Output data to the file* and click [...] on the right side of the **File name** text box to start File Explorer. Select a directory or folder to save the file and enter the file name. (Supported file format is only CSV.)

Contents entered in **Title** on the “Output data editing” dialog in the **Output data** tab will be inserted in the first line of logged data when checking the checkbox for *Add a header when creating a file*”.



Additional Information

- Data is not output when test measurements are executed in TDM editor.
- When *Not output* is selected in *Output device*, no data is output. However, *Output data to the file* has been checked, the data logging is executed.
- When the *serial output* is selected in *Double Speed Multi-input mode*, a queuing processing for communications is executed.
The communication processing for the later executed process gets into a waiting state until the previously started process finishes its output.

5 Specify **Character code**, **Delimiter string**, and **Termination string**.

- Character code: Specify the following code page for each language.

Language	Code page	Language	Code page	Language	Code page
Japanese	932	English	1252	Chinese (simplified)	936
German	1252	French	1252	Chinese (traditional)	950
Italian	1252	Spanish	1252	Korean	949
Vietnamese	1258	Polish	1250		

- The default 0 is no language-dependent letters in ANSI code page.
- For **Delimiter string** and **Termination string**, the following escape sequence codes are also available.
 \n: Carriage return, \r: Line feed, \t: Tab, \r\n: Carriage return line feed

Setting the Output Data

Set the data to output such as processing item data or fixed character strings.

- 1 Click the icon of **Result output (Message)** in the unit list (flow) or **Set** to set the output device.
The setting window for **Result output (Message)** is displayed.

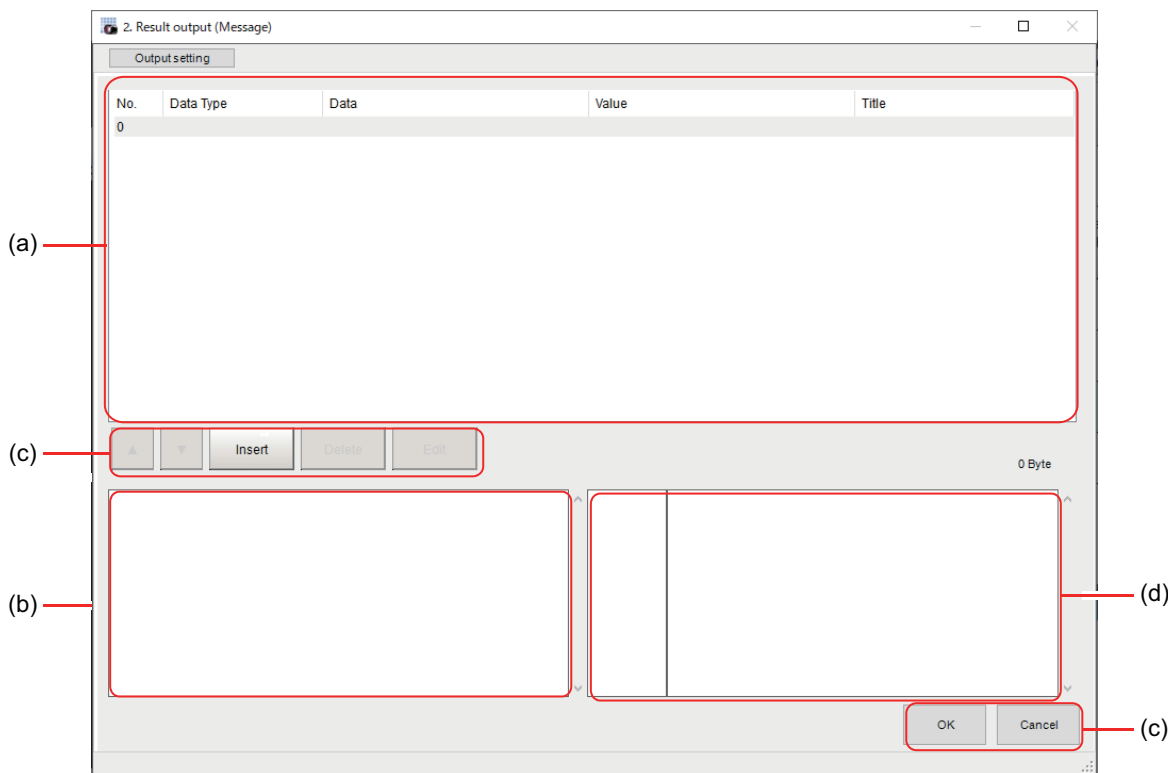

- a) Setting data display area
Display the No. (Output number), Offset (indicating the byte position from the beginning), Data type (Integer, Double, String), Data, Value, and Title (Data description). A value is displayed when a variable is assigned to data.
- b) Output data display area
Output data display area Data to output is displayed as readable characters.
- c) Button

Button	Description
	Moves the selected data up one position.
	Moves the selected data down one position.
	Adds new data to the selected data position.
	Deletes the selected data. The following data moves up after the deletion.
	Edits the selected data.
	Saves the current settings and returns to the previous view.
	Discards the current settings and returns to the previous view.

- d) Binary data display area
Contents in the output data display area in binary (hex) are displayed in this area.

2 In the list, select the output data number to set the output and then click **Insert**. The following **Output data editing** dialog box is displayed.

Setting item	Setting value [Factory default]	Description
Data type	<ul style="list-style-type: none"> Number String 	Set the data type; Number or String
Data	-	There are two input methods. <i>Setting the Output Data</i> on page 2-336 <ul style="list-style-type: none"> Enter strings directly Assign variables
Title	-	Enters the description for data. In the case where the Title has set and <i>Add a header when creating a file</i> is checked, contents entered in <i>Title</i> on the <i>Output data editing</i> dialog in the <i>Output data</i> are inserted in the first line of logged data when creating a csv file.
Numeric setting		This item is valid when <i>Number</i> is selected in <i>Data Type</i> . <i>Output data</i>
Digits of integer	[10]	Sets the number of digits for integer.
Digits of decimal	[4]	Set the number of digits for under decimal.
0 suppress	<ul style="list-style-type: none"> [Fill with space] Fill with 0 	When the number of digits set is bigger than that of input data, fill the set character here to the rest of the set digits.
Minus	<ul style="list-style-type: none"> [-] 8 	Set display format for negative numbers.
String settings		Valid when <i>String</i> is selected in the "Data type".
String length	<ul style="list-style-type: none"> [Auto] Fixed 	Select the format for <i>String length</i> . In <i>Auto</i> , the length is automatically set according to entered string length.
Size	0 to 4095 [10]	Set the number of characters when <i>Fixed</i> is selected in <i>String length</i> .
Character alignment	<ul style="list-style-type: none"> [Left] Right 	Set the display format in the <i>Size</i> when <i>Fixed</i> is selected in <i>String length</i> .

- 3** Click  at the right side of the **Data type** text box to select the data to output. *Number* or *String* can be selected.

Data type	Description
Number	<ul style="list-style-type: none"> Entered data is converted into strings according to specified Digits of integer, Digits of decimal, 0 suppress, and Minus. The number of total digits (integer + decimal) is 15. If it exceeds 15 digits the output data becomes “#ER”. When the number of digits set is bigger than that of input data, the character set in 0 suppress fills the rest of the set digits. When a string variable is selected for the data, a convertible character string such as digits that can be converted into numerical values will be converted for output. Moreover, they are handled as 0 if they are not convertible, e.g. AAA.
String	<ul style="list-style-type: none"> Entered data is set based on String length, Size, and Character alignment”. The number of characters that can be entered is 4,095 maximum. If exceeding this limit, three overflow characters, “...”, are appended in the end of the string, the output will be 4,092 characters + “...”. When <i>Auto</i> is set in String length, the length of an entered string is automatically set to String length. When <i>Fixed</i> is set in String length, the value set in Size is used for the string length. Entered data is displayed at right-justify or left-justify according to the setting in Character alignment. Example: Entered string: “ABCDE”, Size: 3 Right-justify: “CDE” is output. Left-justify: “ABC” is output. When NULL is included in the entered character string, the character string following NULL is not output. The following escape sequence codes can be entered. The entered escape sequence codes are handled as fixed character strings. \N: Carriage return, \r: Line feed, \t: Tab, \xXX: ASCII code specified by “XX” (numerical value), \": Double quotation mark, \: Backslash

4 Enter data, number or string, to **Data** text box.

Directly enter a variable name (Scene variable: SC.~) or specify a variable in *Variable assignment* window displayed by clicking .

- When directly entering a variable name, enclose it with “ ”, e.g. “SC.AA&”.
- When a fixed string, e.g. AA, is entered before a variable, the followed variable is handled as a fixed string.
Example: AA+SC.AA& → “AA+SC.AA&”
- When “String” is selected in the “Data type” but “Integer” or “Double” is set to the variable, then the variable is converted to a string and then output.

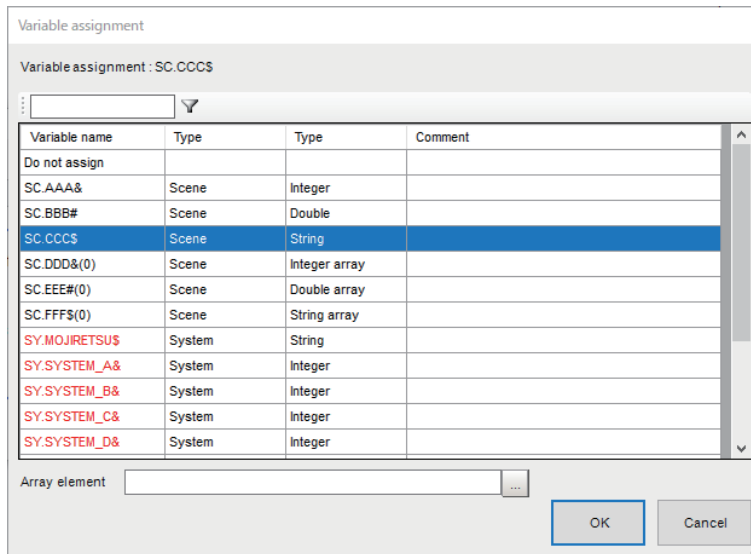

5 Enter *Title* that indicates the content of output data.

6 When *Number* is selected in **Data type**, the following “Numeric setting” area also needs to be set.

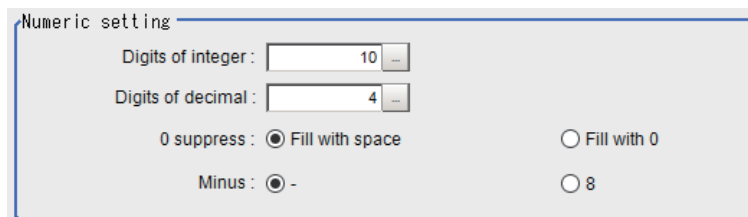

7 When *String* is selected in *Data type*, the following items in *String setting* area also needs to be set.

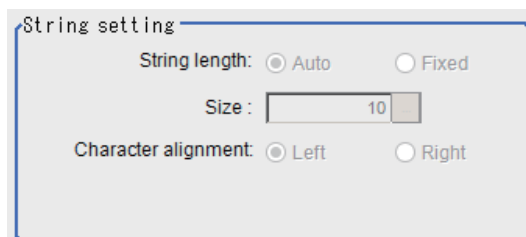

Example:

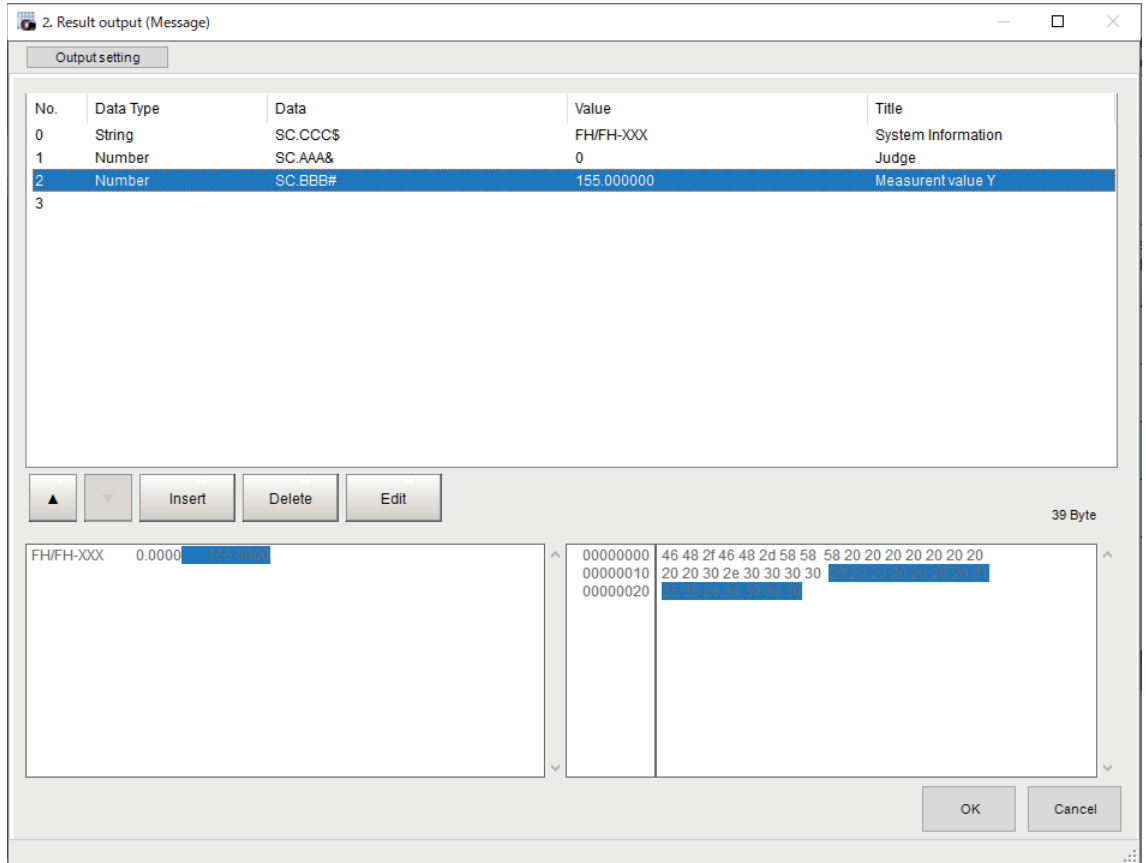

8 Click **OK** in the end of entering data to close the settings.

2-5-7 Testing Communications

You can check whether the *Normal(UDP)* communications settings are correct.

If communications cannot be performed even after set up the communications, use the following procedure to check the settings and the communications status.

When checking the communication settings, stop the program on the external device such as a PLC.

Ethernet Communications

● Before Performing a Communications Test

This example assumes that *Normal (UDP) in the Serial(Ethernet)* is selected as the Communication Module.

When checking the communication settings, stop the program on the external device such as a PLC.

● Checking the Communications Settings

Use the following procedures to check whether or not the communication settings are correct.

The screenshot shows a 'Communication Settings' dialog box with three main sections:

- Address setting:** Contains radio buttons for 'Obtain an IP address automatically' and 'Use the following IP address'. The latter is selected. Below are fields for IP address (10.5.5.100), Subnet mask (255.255.255.0), and Default gateway (10.5.5.100). There are also fields for DNS server, Preferred WINS server, and Alternate WINS server, all set to 0.0.0.0.
- Address setting 2:** Similar to the first section, with 'Use the following IP address' selected. Fields are IP address (10.5.6.100), Subnet mask (255.255.255.0), and Default gateway (10.5.6.100).
- Input/Output setting:** Shows 'Input mode' as Normal and 'Input form' as ASCII. The 'Output IP address' field is highlighted with a red box and contains 0.0.0.0. Below it are 'Input port No.' (9600) and 'Output port No.' (-1) fields.

1. On the Main Window, select [Tool] – [System Settings]. In the tree view on the left, select [System Settings] – [Communication] – [Ethernet Normal (xyz)]. (“xyz” depends on the Communications Module.)
2. Set the IP address of the Sensor Controller. The default settings are as follows:
Address setting: 10.5.5.100
Address setting 2: 10.5.6.100
3. Set the IP address of the PLC or other external device in [Output IP address].
4. Set the port numbers to use for data I/O with the PLC or other external device in [Input port No.] and [Output port No.]. Set the same number as the number for the PLC or other external device.
5. This completes the Controller settings.

● Checking the Communications Status

Use the ping command to check whether or not the Sensor Controller exists on the Ethernet network.

With it, check that the Sensor Controller IP address has been correctly set and is correctly connected to the Ethernet network.



Additional Information

The ping command uses the ICMP protocol to send a response request to a device connected through an Ethernet network and determines the time required to respond to that request. If you properly receive a response from the destination device, the network connection and network settings are correctly set.

- 1 Connect the Sensor Controller and a computer with an Ethernet cable. Set the high-order digits of the computer IP address to the same values as the Sensor Controller and the low-order one digit to a different value.

<IP Address Setting Example>

Device	Example
Sensor Controller	10.5.5.100 (default)
Computer	10.5.5.101

- 2 Open the Windows command prompt on the computer and perform the ping command. At the > prompt, type *ping*, followed by a space and the Sensor Controller IP address, and then press *Enter*.

Example:

```
C:\>ping 10.5.5.100
```

- 3 After a few seconds, *Reply from* followed by the IP address of the Sensor Controller (e.g., 10.5.5.100) are displayed, it means that the Sensor Controller is connected to the Ethernet network properly.

Example:

```
Reply from 10.5.5.100: byte=32
```

```
Time<1 ms TTL=128
```

If anything other than *Reply from* is displayed:

The Sensor Controller is not connected to the Ethernet network for some reason. Check the following.

- Are the high-order three digits of the IP addresses for the computer and the Sensor Controller the same?
- Is the Ethernet cable correctly connected?

- 4 Use the ping command to check the communication status of the external device such as a PLC as well. After you have confirmed the communication status as described above, transmit a measurement command to the Sensor Controller in practice to check the communication operations as the Vision Sensor.

RS-232C Communications

● Before Performing a Communications Test

This example assumes that *Serial (RS-232C/422) – Normal* or *Normal (Fxxx series method)* is selected as the Communications Module.

When checking the communication settings, stop the program on the external device such as a PLC.

● Checking the Communication Settings

Use the following procedures to check whether or not the communication settings are correct.

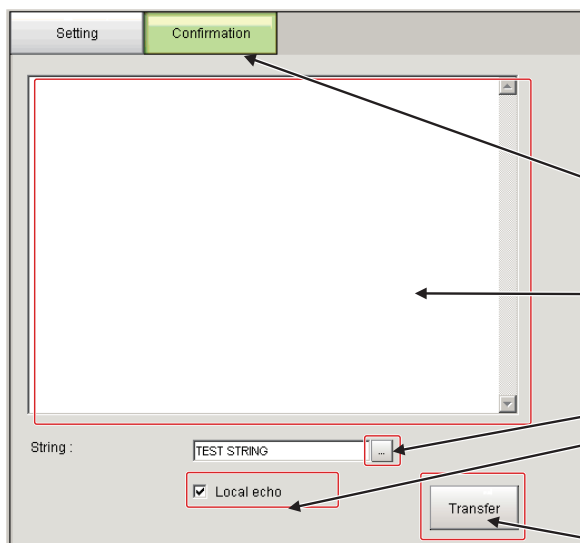

1. On the Main Window, select [Tool] – [System Settings]. From the tree view on the left, select [System Settings] and then select [Communication] – [RS-232C/422 (Normal)] or [RS-232C/422 (Normal (Fxxx series method))].

2. Click the [Confirmation] tab.

Reception Confirmation:

3. Send an ASCII character string to the Sensor Controller from the PLC or other external device.
4. The command received from the PLC or other external device will be displayed here, following [Receive].

Transmission Confirmation:

5. Click the button to the right of [TEST STRING].
6. Enter the character string (12 characters or less) that you want to send to test communications. Select [Local echo] if you want to perform an echo check of the sent character string.
7. Click the [Transfer] button to send the input character string to the PLC or other external device.
8. If [Local echo] was selected, the character string that was sent will be displayed after [Send].
9. Confirm that the character string was received by the PLC or other external device.

If character strings were not sent or received, check the following:

- Are the communication settings correct for the connected device?
- Is the cable connected?
- Are all cables wired correctly?

After you have confirmed the communication status as described above, send an actual measurement command to the Controller and check to confirm that Vision Sensor communications are operating correctly.

2-5-8 Output Items

Measurement Results That You Can Output with the Data Output Processing Item

The following data can be output using the processing items related to the Result Output. Measurement values are also referred using processing units such as expressions.

Measurement items	Character string	Description
Judgment	JG	Judgment result
Data 0 to 7	D000 to D007	Results of expressions set for output data 0 to 7.

External Reference Table for the Data Output Processing Item

By specifying a number, the following data can be referenced from control commands or processing items that have a set/get unit data function.

Number	Data name	Set/Get	Data range
0	Judgment	Get only	0: No judgment (unmeasured) 1: Judgment result OK -1: Judgment result NG
136	Communications method	Set/Get	0: Ethernet 1: RS-232C
137	Output format	Set/Get	0: ASCII 1: Binary
138	Digits of integer	Set/Get	1 to 10
139	Digits of decimal	Set/Get	0: 0 to 4: 4
140	Minus	Set/Get	0: -, 1: 8
141	Field separator	Set/Get	0: OFF, 1: Comma, 2: Tab, 3: Space 4: Delimiter
142	Record separator	Set/Get	0: OFF, 1: Comma, 2: Tab, 3: Space 4: Delimiter
143	0 suppress	Set/Get	0: No, 1: Yes
144 to 147	Output IP Address 1 to 4 (only when <i>Ethernet</i> is selected for the communications method)	Set/Get	Destination IP addresses
149	Output IP Address Setting (only when <i>Ethernet</i> is selected for the communications method)	Set/Get	0: Reference to system, 1: Individual specification
150	Output form (decimal)	Set/Get	0: Fixed point, 1: Floating point
151	Offset	Set/Get	0 to 99999
152	Number of output data items (PLC Link communications only)	Set/Get	8 to 256
153	Plus	Set/Get	0: No, 1: +
1,000 to 1,002	Data 0 to Data 7	Get only	<ul style="list-style-type: none"> ASCII: -99,999,999.999 to 999,999,999.999 Binary: -2,147,483.648 to 2,147,483.647



Additional Information

If you are using external reference numbers 5 to 12 on an FZ4 series or earlier model, use 1,000 to 1,007 on the FH/FHV series.

2-5-9 Command Formats

This section describes the format of commands to be used in Non-procedure communications.



Precautions for Correct Use

Japanese characters cannot be used.
To load a scene or other data, set the file name with alphanumeric characters in advance.

An Input Format Example

• When the parameter is a numeric

Example: Get the display status with IMAGEDISPCOND.

<Command Format>

I M A G E D I S P O N D C_R

Space Number of the Image Pane (Maximum number of line is 2.)

Enter a delimiter at the end of commands. In this manual, delimiters are expressed with C_R.
Separate parameters with spaces (Not required before delimiters).



Precautions for Correct Use

When connected via Ethernet (UDP), a Delimiter is not necessary in the command.
Also, note that there are no Delimiters for responses.
Make sure to enter a Delimiter when the other communication protocols are used.
Also, note that there are delimiters for responses.

<Response Format>

The command was processed correctly:

Image mode C_R

Acquired data

OK C_R

0: Through
1: Freeze
2: Last NG

Only OK is returned when there is no data, such as Scene switch, to get.

<Response Format>

The command was not correctly processed:

ER C_R

ER is returned at the following cases:

- When a command which does not exist was specified.
- When the number of parameters is not correct.
- When the specified parameter range is not correct.
- When the contents of the specified parameter are not correct.
- When the specified operation did not correctly terminate.



Additional Information

In Ethernet, when the acquired data and the OK response are continuous, those are transmitted as a separate packet.

• **When a parameter is a character string**

The character string must be enclosed with double quotation marks.

Example: Save Scene with SCENESAVE command.

<Command Format>

SCNSAVE	0	"	C:\Data\RAMDisk\ABC.SCN	"	C	R
---------	---	---	-------------------------	---	---	---

Example: Set the prefix of a Logging file name to *Undefined* with SYSDATA command.

<Command Format>

SYSDATA	Logging	imageLoggingHeader	"	"	C	R
---------	---------	--------------------	---	---	---	---

OK Response in Non-procedure Communications (Fxxx series method)

The OK response for [Normal (Fxxx series method)] communications is compatible with the communications method for F□□□ series Vision Sensors.

The timing of the OK response when the Sensor Controller receives a MEASURE command with the [Normal (Fxxx series method)] communications method is the same as the timing for an F□□□ series Vision Sensor.

For details, refer to 2-5-3 *Communications Module Settings (Startup Settings)* on page 2-319.

Non-procedure Communications

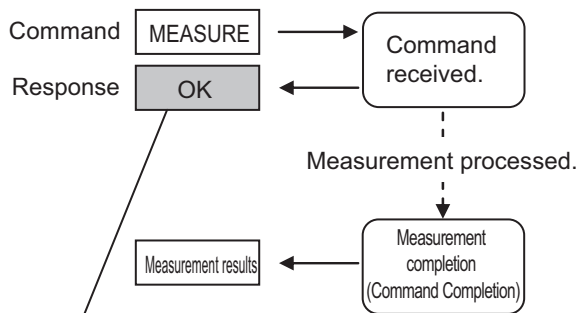

An OK response is returned when the Controller receives the command.

Non-procedure Communications (Fxxx-series Method)

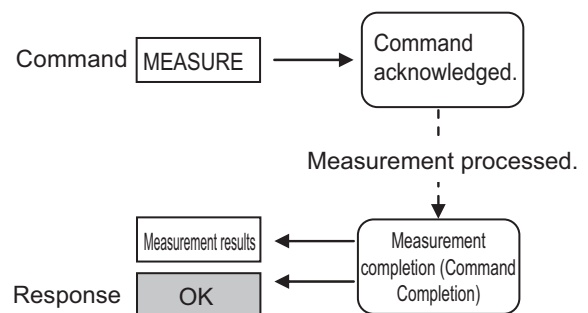

An OK response is returned when execution of the command is completed.

2-5-10 Command List

This section explains the input format for each command used for serial Non-procedure (normal) communications. Commands are input with ASCII text. Both lowercase and uppercase letters can be used. For details of commands, refer to *A-1-5 Non-procedure Command Details* on page A-81.

● Execution Commands

Command	Abbreviation	Function	Reference
BRUNCHSTART	BFU	Branches to the start of the measurement flow (processing unit 0).	page A-84
CLRMEAS	None	Clears all measurement result values.	page A-84
CPYSCENE	CSD	Copies the scene data.	page A-84
DATASAVE	None	Saves the current system data and scene group data in the Sensor Controller.	page A-90
DELSCENE	DSD	Deletes the scene data.	page A-93
ECHO	EEC	Returns an entered text string without changing it.	page A-98
IMAGEFIT	EIF	Returns the display position and display magnification to their default values.	page A-105
IMAGESCROLL	EIS	Shifts the image display position by the specified amount.	page A-111
IMAGEZOOM	EIZ	Zooms the image display in or out by the specified factor.	page A-116
MEASURE	M	Performs measurement one time.	page A-127
		Performs continuous measurement.	page A-127
		Ends continuous measurements.	page A-128
MEASUREUNIT	MTU	Performs test measurement for the specified unit.	page A-129
MOVSCENE	MSD	Moves the scene data.	page A-130
REGIMAGE	RID	Registers the specified image data as a registered image.	page A-144
		Loads the specified registered image as the measurement image.	
RESET	None	Restarts the Sensor Controller.	page A-146
TIMER	TMR	Executes the specified command string after a specified delay.	page A-163
UPDATEMODEL	UMD	Registers the model again.	page A-166
USERACCOUNT	UAD	Adds a user account to a specified group ID.	page A-167
		Deletes a specified user account.	

● Commands to Get Status

Command	Abbreviation	Function	Reference
DIPORTCOND	DPC	Gets the ON/OFF status of all parallel DI terminals.	page A-96
IMAGEDISPCOND	IDC	Gets the image mode for the specified image display window.	page A-103

Command	Abbreviation	Function	Reference
IMAGESUBNO	ISN	Gets the sub-image number that is currently displayed in the specified image display window.	page A-112
IMAGEUNITNO	IUN	Gets the number of the Unit that is currently displayed in the specified image display window.	page A-114
INPUTTRANSSTATE	ITS	Gets the input status (prohibited/permitted) for the Communications Modules.	page A-119
LAYOUTNO	DLN	Gets the number of the layout that is currently displayed.	page A-122
LOGINACCOUNT	LAI	Gets the user name for the user account currently logged in.	page A-124
LOGINAC-COUNTGROUP	LAG	Gets the group ID for the account currently logged in.	page A-126
OPELOGCOND	OLC	Gets the current state of the operation log.	page A-131
OUTPUTTRANS-STATE	OTS	Gets the output status (prohibited/permitted) to an external device.	page A-132
PARAALLCOND	PAC	Gets the ON/OFF status of all parallel terminals except for DI terminals.	page A-134
PARAPORTCOND	PPC	Gets the ON/OFF status for the specified parallel I/O terminal.	page A-139
SCENE	S	Gets the current scene group number.	page A-147
SCNGROUP	SG	Gets the current scene group number.	page A-152

● Commands to Set Status

Command	Abbreviation	Function	Reference
DOPORTCOND	DPC	Sets the ON/OFF status of all parallel DO terminals.	page A-97
IMAGEDISPCOND	IDC	Sets the image mode for the specified image display window.	page A-103
IMAGESUBNO	ISN	Gets the sub-image number that is currently displayed in the specified image display window.	page A-112
IMAGEUNITNO	IUN	Sets the number of the Unit to display in the specified image display window.	page A-114
INPUTTRANSSTATE	ITS	Permits/prohibits inputs to the Communications Modules.	page A-119
LAYOUTNO	DLN	Sets the layout number and switches the image.	page A-122
LOGINACCOUNT	LAI	Switches the currently logged in account.	page A-124
OPELOGCOND	OLC	Sets the state of the operation log.	page A-131
OUTPUTTRANS-STATE	OTS	Permits/prohibits outputs to external devices.	page A-132
PARAALLCOND	PAC	Sets the ON/OFF status of all parallel terminals except for DO terminals.	page A-134
PARAPORTCOND	PPC	Sets the ON/OFF status of the specified parallel I/O terminal.	page A-139
SCENE	S	Switches to the specified scene number.	page A-147
SCNGROUP	SG	Switches to the scene group with the specified number.	page A-152

● Commands to Read Data

Command	Abbrevia- tion	Function	Reference
DATALOGCOND	DLC	Gets the conditions set for data logging.	page A-85
DATALOGFOLDER	DLF	Gets the data logging folder name.	page A-88
DATE	None	Gets the date and time.	page A-91
DIOFFSET	DIO	Gets the parallel DI terminal offset data that is set.	page A-94
IMAGECAPTURE- FOLDER	ICF	Gets the screen capture folder name.	page A-101
IMAGELOGFOLDER	ILF	Gets the image logging folder name.	page A-107
IMAGELOGHEADER	ILH	Gets the prefix for the file name in which logged images are saved.	page A-109
SCNDATA	None	Gets the value for a scene variable.	page A-149
SYSDATA	None	Gets settings related to image logging.	page A-158
UNITDATA	UD	Gets the specified processing unit data.	page A-164
VERGET	None	Gets the Sensor Controller version information.	page A-170

● Commands to Write Data

Command	Abbrevia- tion	Function	Reference
DATALOGCOND	DLC	Sets the data logging conditions.	page A-85
DATALOGFOLDER	DLF	Sets the name for the data logging folder.	page A-88
DATE	None	Sets the date and time.	page A-91
DIOFFSET	DIO	Sets the parallel DI terminal offset data.	page A-94
IMAGECAPTURE- FOLDER	ICF	Sets the name for the screen capture folder.	page A-101
IMAGELOGFOLDER	ILF	Sets the name for the image logging folder.	page A-107
IMAGELOGHEADER	ILH	Sets the prefix for the file name in which logged images are saved.	page A-109
SCNDATA	None	Sets value to scene variable	page A-149
SYSDATA	None	Changes the settings related to image logging.	page A-158
UNITDATA	UD	Sets the specified unit data.	page A-164

● File Load Commands

Command	Abbreviation	Function	Reference
BKDLOAD	None	Loads the system + scene group 0 data.	page A-82
SCNLOAD	None	Loads the scene data.	page A-154
SGRLOAD	None	Loads the scene group data.	page A-156
SYSLOAD	None	Loads the system data.	page A-160

● File Save Commands

Command	Abbreviation	Function	Reference
ALLIMAGESAVE	AIS	Saves all image data in the Sensor Controller's memory with ifz format in external storage.	page A-81
BKDSAVE	None	Saves the system + scene group 0 data that is currently used by the Sensor Controller in a file.	page A-83
IMAGECAPTURE	EIC	Captures the screen.	page A-99
IMGSAVE	None	Saves the image data stored in the the Sensor Controller's memory.	page A-117
LASTIMAGESAVE	LIS	Saves the last logging image.	page A-121
SCNSAVE	None	Saves the scene data.	page A-155
SGRSAVE	None	Saves the scene group data.	page A-157
SYSSAVE	None	Saves the system data.	page A-161

2-5-11 Output Format

When the processing unit *Data Output* is placed in a scene, measurement results are sequentially output starting from the smallest data number set in **Setting** of *Data Output*. You can also place more than one Data Output Unit in the measurement flow. You can then use record separators to identify the data for individual Data Output Units.

For details, refer to *Output Format (Data Output)* on page 2-330.

Outputting ASCII Data

Set the output format as *ASCII* in *Output form* of the *Data Output* processing item.

The default setting is *ASCII*.

● Output Format

Data 0 measurement value	,	Data 1 measurement value	,	...	Data 7 measurement value	C _R
--------------------------	---	--------------------------	---	-----	--------------------------	----------------



Additional Information

The output format, number of digits, data separator, etc., can be changed as necessary. For details, refer to *2-5-5 Output Data Settings (Processing Item Registration)* on page 2-328

Example: Integer digits: "5 digits", decimal places: "3 digits", negative numbers: -, field separator: *comma*, record separator: *delimiter*.

1	2	3	4	5	.	6	7	8	,	5	6	7	.	3	2	1	,	...	6	5	9	8	7	.	1	6	5	C _R	
Data 0 measurement value									Data 1 measurement value							Data 2 measurement value							Data 7 measurement value						
									Field separator														Record separator						



Additional Information

- Field separators are not output if there is no following data.
- Lower decimal digits of the data are rounded off and then the data is output.

The range of values that can be output is as follows:

$-999,999,999.9999 \leq \text{Measurement value} \leq 999,999,999.9999$

When measurement value $< -999,999,999.9999$, "-999,999,999.9999" is output.

When measurement value $> 999,999,999.9999$, "999,999,999.9999" is output.

When JG (Judgement) is set, the following values are output.

OK: 1

NG: -1



Additional Information

After the measurement was completed, the measured data is continuously output until all the data is output. Note that the output cannot be interrupted.

Outputting Binary Data

Set the output format as *Binary* in *Output form* of the *Data Output* processing item.

● Output Format

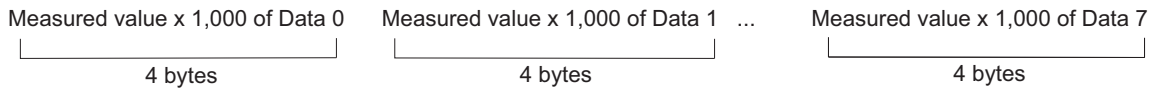

The measurement data is multiplied by 1,000 and output is continuous with 4 bytes per data item. Negative numbers are output in 2's complement format.

For details of *2's Complement*, refer to *Definitions of Basic Terms* in the *Vision System FH/FHV Series User's Manual (Cat. No.Z365)*.

Example: When Data 0 is 256.324, and data 1 is -1.0000.

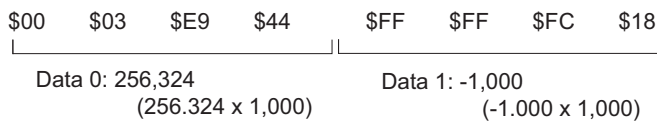

Additional Information

Unlike ASCII output, binary output has no separators between data, such as field separators or record separators.

For details, refer to *Output Format (Data Output)* on page 2-330

The range of values that can be output is as follows:

$-2,147,483.648 \leq \text{Measurement value} \leq 2,147,483.647$

When measurement value $< -2,147,483.648$, $-2,147,483.648$ is output.

When measurement value $> 2,147,483.647$, $2,147,483.647$ is output.

When JG (Judgement) is set, the following values are output.

OK: 1,000 ($1 \times 1,000$)

NG: -1,000 ($-1 \times 1,000$)



Additional Information

After the measurement was completed, the measured data is continuously output until all the data is output. Note that the output cannot be interrupted.

2-5-12 Non-procedure Communications Troubleshooting

Cannot Input to the Sensor Controller

Problem	Cause	Action
No response is received after sending communication commands.	The wiring is incorrect.	Check the wiring. Check the cable connections.
	There is a problem with the communication specification settings.	Make sure that the settings are correct.
	Communications has not been established just after the Sensor Controller start-up. (It requires more time to establish the communications.)	Check whether or not the communications are available between the Sensor Controller and external devices after the Sensor Controller turned on.*1 Then start communications and measurement for ordinary operations.
No response is received after sending communications commands. (Communications were properly working previously.)	Commands are sent while the BUSY signal is ON.	Send commands while the BUSY signal is OFF.
	A cable is broken.	Check the cable connections.
	A connector has been disconnected.	Check the connector connections.
	The Sensor Controller is in Edit Mode.	Change it to RUN or ADJUST Mode.

*1. Commands to get status such as SCENE command allow you to confirm availability of communications between the Sensor Controller and external devices.

After starting up the Sensor Controller, send commands to get status from external devices to the Sensor Controller. When the Sensor Controller returns correct responses to external devices, no problem in communications between them are confirmed.

No Data Is Output from the Sensor Controller

Problem	Cause	Action
No data is output at all.	The output IP address is incorrect. (Ethernet communications only)	Set the output IP address correctly.
	The wiring is incorrect or a cable is broken.	Check the wiring. Check the cable.
	A connector has been disconnected.	Check the connector connections.
	You have not placed any Data Output processing items in the measurement flow.	Place Data Output processing items in the measurement flow.
	The <i>Output</i> option is not selected in the Adjustment window.	Place a check to the <i>Output</i> option in the Adjustment window.
	The target output device for the Data Output Unit is incorrect.	Make sure that the setting is correct.

Problem	Cause	Action
	Communications has not been established just after the Sensor Controller start-up. (It requires more time to establish the communications.)	Check whether or not the communications are available between the Sensor Controller and external devices after the Sensor Controller turned on.*1 Then start communications and measurement for ordinary operations.
Data is sometimes output and sometimes not.	A cable is broken or there is a connection problem.(RS-232C communications only)	Check the cable connections.
	The measurement commands are not being received. (RS-232C communications only)	Check to confirm that an OK response is being returned after sending a measurement command.

- *1. Commands to get status such as SCENE command allow you to confirm availability of communications between the Sensor Controller and external devices.
After starting up the Sensor Controller, send commands to get status from external devices to the Sensor Controller. When the Sensor Controller returns OK responses to external devices, no problem in communications between them are confirmed.

Slow Operation

Problem	Cause	Action
Response and data output is slow.	The baud rate is too low for the amount of data to be transferred.	Increase the baud rate for communications or use a different communications method.

Communications Between the Sensor Controller and External Devices are not Correctly Done (EtherNet only)

Problem	Cause	Action
The Sensor Controller cannot communicate with an external device such as a PLC properly. (Only for Ethernet)	The communication settings such as IP address have been changed after the Device information storage tool was performed. (The IP addresses for external devices on the network may have overlapped the IP addresses stored in the Sensor Controller.)	Check that the communication settings such as IP address are correct. (Tool menu - System setting - Communication - Ethernet) Perform the Device information storage tool again. The communication settings in the software will be copied in the Sensor Controller.

Communications Fail just After Start-up of the Sensor Controller

Problem	Cause	Action
The Sensor Controller does not respond even serial commands are sent to it just after its start-up.	Communications are not established just after start-up of the Sensor Controller. (To establish communications between the Sensor Controller and external devices takes time.)	After confirming that communications are available between the Sensor Controller and external devices after startup of it, send serial commands and start measurement.
No data is output from the Sensor Controller just after its start-up.		



Additional Information

Commands to get status such as SCENE command allow you to confirm availability of communications between the Sensor Controller and external devices.

After starting up the Sensor Controller, send commands to get status from external devices to the Sensor Controller.

When the Sensor Controller returns correct responses to external devices, no problem in communications between them are confirmed.

2-6 Parallel Communications

This section describes the communication settings, communication specifications, input/output format, and communication timing chart required for parallel communications between the Sensor Controller and external devices.

2-6-1 Communications Processing Flow

The Sensor Controller communicates with external devices via a parallel interface.

I/O Signals and Data for Communicating with External Devices

This section describes the basic connections and signal flow with external devices.

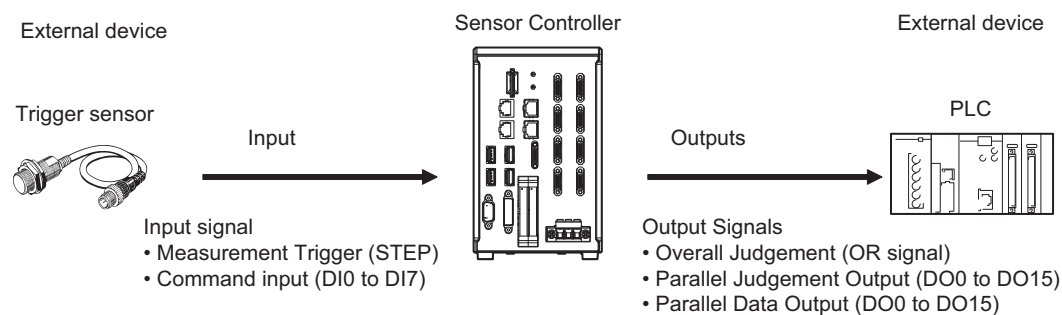

● Inputs

You can input the following signals to the Sensor Controller while the Main window is displayed.

- **Measurement Trigger (STEP signal)**

Measurement is performed once when STEP signal turns ON. (Single Measurement)

- **Command Input (DI0 to DI7 Signals)**

You can send commands and control the Sensor Controller by turning the DI0 to DI7 signals ON and OFF. For details of Sensor Controller control commands, refer to *2-6-10 Command Formats* on page 2-398.



Precautions for Correct Use

Note that if DI7 is ON after the command is executed, the command will be executed repeatedly. For details, refer to *DI0 to DI7 (Command Execution) Timing* on page 2-393 *Multi-line Random-trigger Mode*

● Outputs

Each time measurement is performed, the measurement results are output.

The following measurement results can be output:

- **Overall Judgement (OR signal)**

The results of more than one processing item are judged.

The overall judgement will be NG if even one of the individual judgement results is NG^{*1}.

*1 : With the default settings, output is performed even if the overall judgement result is NG, but this can be changed so that output is performed only when the overall judgement result is OK. For details, refer to *Setting the Output Signal Specifications* on page 2-364.

- **Parallel Data Output (DO0 to DO15 Signals)**

The measured values of processing items or the calculation results of expressions are output. This processing item can not be used in the FHV series.

- **Parallel Judgement Output (DO0 to DO15 Signals)**

The measured values of the processing items or calculation results are judged and the judgement results are output.

This processing item can not be used in the FHV series.

Result output (Parallel I/O)(DO0 to DO15 Signals)

Outputs the measurement value of the processing item and the calculation result of the calculation formula. It is also possible to judge the measurement value or calculation result of the processing item and output the judgment result.

To use this processing item in the FHV series requires that the camera be connected by the Smart Camera Data Unit (Parallel Interface) FHV-SDU10.



Additional Information

If the operation mode is set to Multi-line Random-trigger mode and the number of lines to use simultaneously was increased, the signal type and details of control and output are different from a single line used as described in the following table.

For the signals that can be used and for differences in assignments, refer to *Multi-line Random-trigger Mode Signal Specifications* on page 2-391.

FH-2000 / FH-5000 series Sensor Controller

Number of controlled lines	Differences from when only a single line is used (i.e., when the operation mode is not set to <i>Multi-line Random-trigger Mode</i>)
2 lines	<ul style="list-style-type: none"> • The usable functions are the same as for when only a single line is used. • DO signals are divided as follows: Line 0: DO0 to DO7, Line 1: DO8 to DO15
3 or 4 lines	<ul style="list-style-type: none"> • Parallel data output and parallel judgement output cannot be performed (DO signals cannot be used). • Handshaking output cannot be used (the GATE signal and DSA signal cannot be used). • An encoder cannot be used.
5 to 8 lines	<ul style="list-style-type: none"> • The RUN signal cannot be used. The same ERR signal is used for all lines. • Parallel data output and parallel judgement output cannot be performed (DO signals cannot be used). • Handshaking output cannot be used (the GATE signal and DSA signal cannot be used). • An encoder cannot be used.

2-6-2 Communications Setup Procedures

The following settings are required to use Parallel.

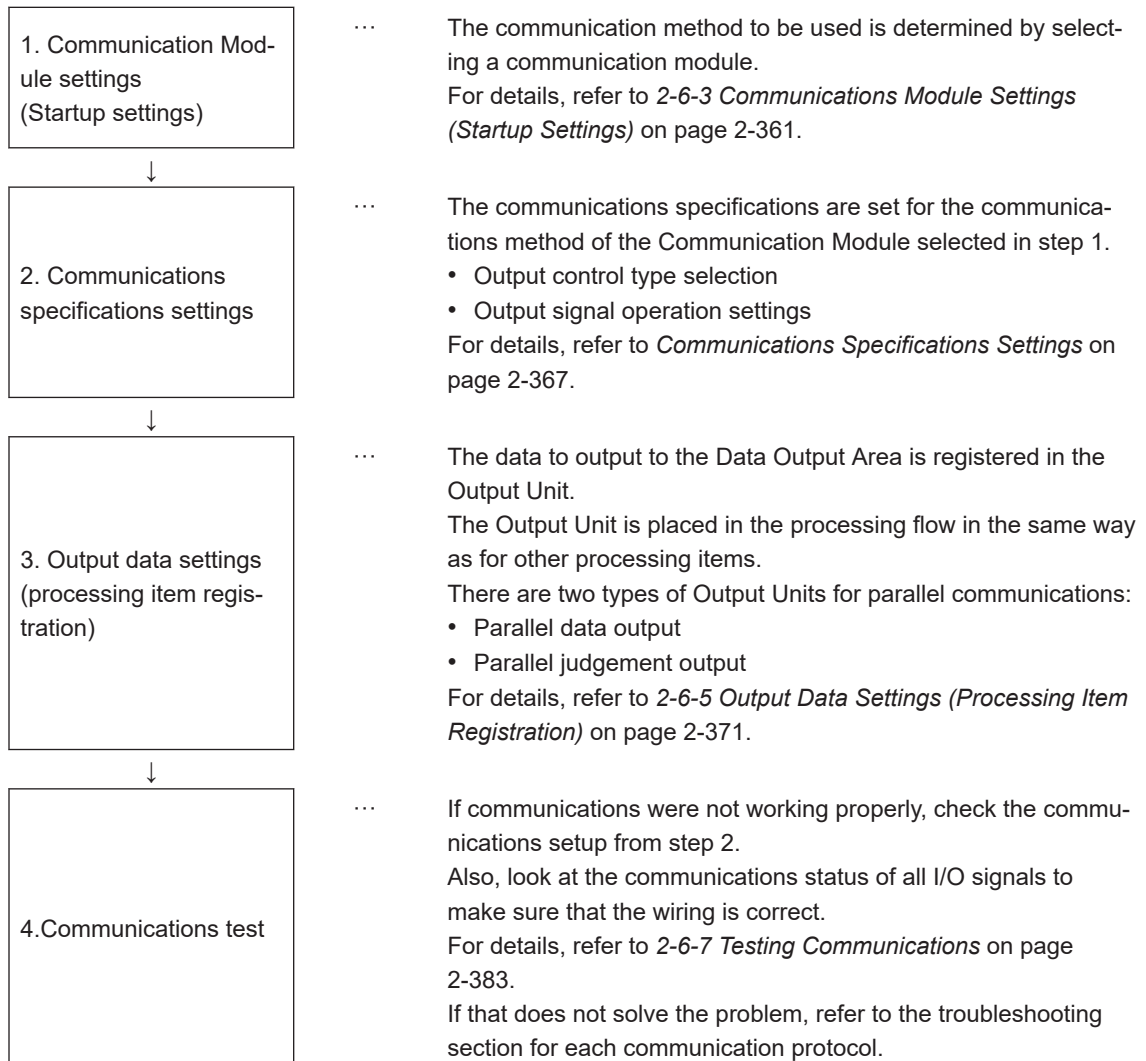

2-6-3 Communications Module Settings (Startup Settings)

The communication method used for communication with the Sensor Controller is selected from the communication modules.

- 1 On the Main window, click **Tool - System Settings** to open the system settings.
- 2 On the Multiview Explorer on the left, select **System settings - Startup - Startup setting** and then click the **Communication** tab.

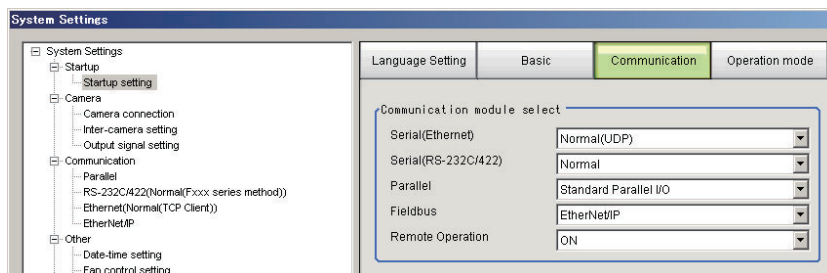

- 3 Select one of the following Communication Modules based on the communication method used to connect with the Sensor Controller and the Unit to be connected, and then click **Apply**.

Communications Module	Description
Parallel	Select this Communication Module to perform Parallel interface.
StandardParallel I/O	

- 4 Click **Data save** in the Toolbox Pane.

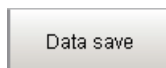

- 5 On the Main window, click **Function - System restart**.
- 6 Click **OK** in the System restart dialog box to restart the Sensor Controller. When the Sensor Controller was restarted, the set Communication Module will operate with the default settings.



Additional Information

You can save the Communication Module settings to a file. Use the *System data* or *System + Scene group 0 data* option for saving settings to a file. For details, Refer to *Saving Settings Data to the Controller RAM Disk or an External Storage Device* in the *Vision System FH/FHV Series User's Manual (Cat. No. Z365)*.

2-6-4 Communications Specifications Settings

Set the communications specifications, such as the data output method and data signal operation. If communications cannot be performed even after setting these communications settings, check the settings and the communications status.

For details, refer to *2-6-7 Testing Communications* on page 2-383.



Precautions for Correct Use

- Before you set the communication specifications, select the Communication Module to use with the Sensor Controller in the startup settings.
For details, refer to *2-6-3 Communications Module Settings (Startup Settings)* on page 2-361.
- After you selected the Communication Module, save the settings to the Sensor Controller and restart it.
If you do not restart the Sensor Controller, the selected Communication Module will not be enabled.



Additional Information

Input signals cannot be handled during setting of communications specifications. However, the input status can be checked with *Confirmation*.

For details, refer to *2-6-7 Testing Communications* on page 2-383.

Selecting the Output Control Type

You can select how to control the data output timing to synchronize the timing of output with the external device.

● Types of Output Control

• None

After measurement was completed, the Sensor Controller outputs the measurement results without synchronizing with the external device.

Since the GATE signal is also output with it, adjust the reading timing for the output results in the external device based on the GATE signal.

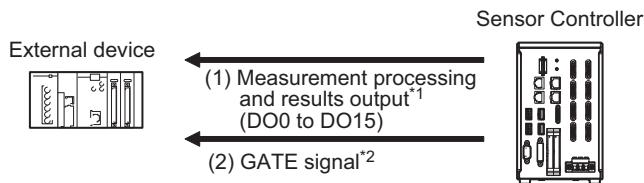

*1 : Overall judgment (OR) output is output when the measurement is completed, regardless of when the Output Unit was executed.

*2 : You can change the settings for time to be turned ON the GATE signal after the measurement data was output and the duration that the GATE signal remains ON.

For details, refer to *Communications Specifications Settings* on page 2-367.



Additional Information

The GATE signal will not be output if there is no data set for parallel judgment output and parallel data output.

If only the OR signal is output, read the OR signal when the BUSY signal turns OFF.

- **Handshaking**

Measurement results are output only after it is determined that the external device can receive data.

Handshaking is effective for sequentially outputting many measurement results, which is a reliable way to transfer data.

For details, refer to *Data Output Control with Handshaking* on page 1-24.

- **Synchronization Output**

The measurement results are output after the STEP signal has turned ON for the number of delays set in *Number of delays*.

The output timing of the measurement results from the Sensor Controller can be offset according to the actual timing of processing on the line.

Example: Sequential Feed Line that Uses a Star Wheel

The discharge timing for when a defective part is found and the measurement results output timing can be synchronized.

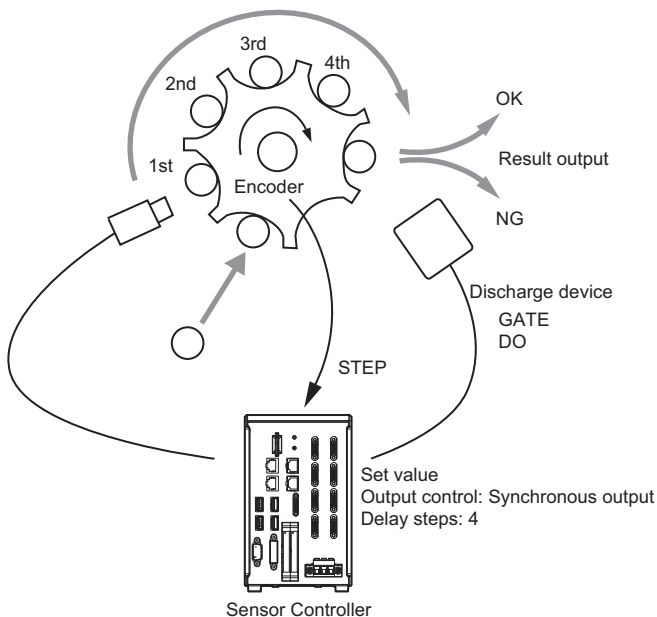

Additional Information

- As the steps will be counted according to the number of times the STEP signal turns ON while *Synchronized output* is selected, set that results are output only once for each measurement. (Place only one Output Unit in the measurement flow. In the case of Parallel Judgment Output and Parallel Data Output, either one can be set. In Parallel Data Output, only one output item is allowed.)
- Designate only the STEP signal for measurement trigger input. When a serial command is used for single measurement or continuous measurement, the output timing will not match and this can cause Sensor Controller malfunctions.

Setting the Output Signal Specifications

You can change the operation of signals output with parallel communications.

● Changing the Judgement Output ON Conditions (Output Polarity)

The ON conditions for the OR signal and the DO0 to DO15 signals can be set to turn ON the signals when the judgment results are OK or when they are NG. The default setting is *ON at NG*.

This setting can be changed by setting the *Output polarity* in the communications specifications. For details, refer to *Communications Specifications Settings* on page 2-367.

● Setting the Timing to Turn OFF the Overall Judgment (OR) signal (One-shot Output)

You can select from the following two methods for the timing of when the Overall Judgment (OR) signal turns OFF after measurement result confirmation.

This setting can be changed by setting *One-shot OR signal* in the communications specifications. For details, refer to *Communications Specifications Settings* on page 2-367.

• One-shot Output Disabled (Default)

The OR signal stays ON until the judgment changes.

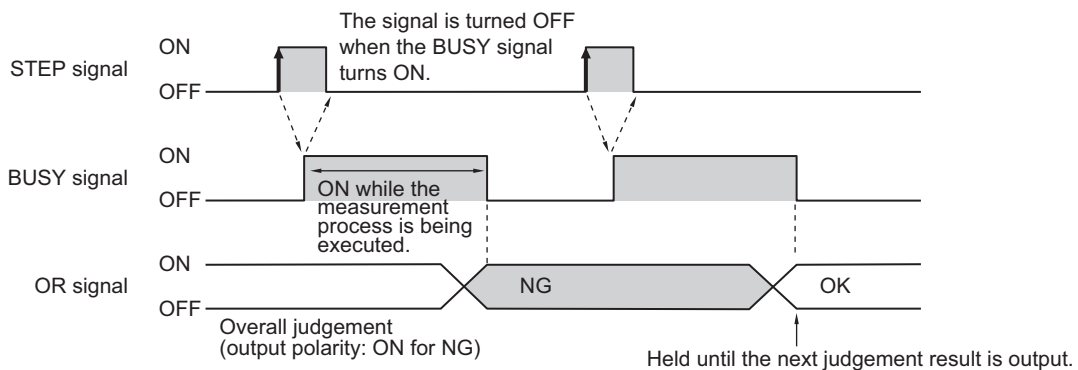

• One-shot Output

OR signal output stays ON for a certain amount of time, and then it is turned OFF again.

The time to maintain the OR signal output can be specified. (Setting range: 0.1 to 1000.0 [ms])

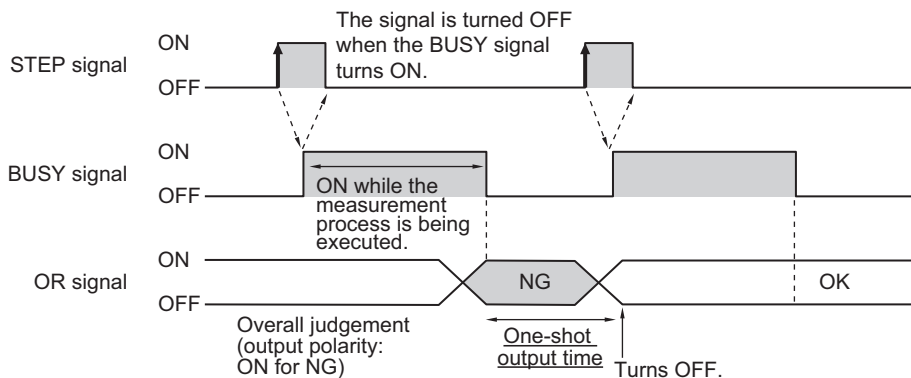

● Outputting the STGOUT and SHTOUT Signals

These functions are supported by the FH series Sensor Controllers only.

With parallel communications, the STGOUT signal (strobe trigger output) and SHTOUT signal (shutter output) cannot be output at the same time.

Select which signal to output based on your needs.

- 1 On the Main Window, select **System Settings – Camera – Output Signal Setting** from the **Tool** menu.

The output signal settings dialog box is displayed.

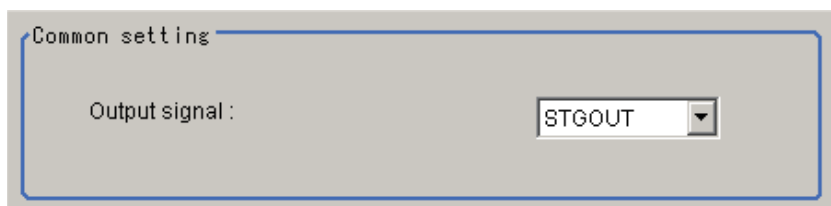

- 2 Select the signal to output in the **Common** area.

Setting item	Setting value [Factory default]	Description
Output signal	<ul style="list-style-type: none"> • [STGOUT] • SHTOUT 	STGOUT sets how to use the signal line. STGOUT: Uses the STGOUT signal line as the STGOUT signal. SHTOUT: Uses the STGOUT signal line as the SHTOUT signal.



Additional Information

- In Multi-line Random-trigger Mode, this output signal selection can be used to set the output signal for line 0 only. The setting for line 0 will be used for all other lines.
- The STGOUT signal output settings must be set in the *Electronic flash setting* for each Camera Image Input processing item.



Precautions for Correct Use

SHTOUT signals output through EtherCAT communications are not affected by this setting.

● SHTOUT Signal Settings: [Output Signal Setting]

These functions are supported by the FH series Sensor Controllers only.

This setting sets the SHTOUT signal that is output when the Camera exposure is completed. By detecting when the exposure is completed using the SHTOUT signal, you can minimize the amount of time that the workpiece must be kept still for imaging and you can move the Camera or workpiece immediately after the exposure is completed.

- 1 On the Main Window, select **System Settings – Camera – Output Signal Setting** from the **Tool** menu.

The output signal settings dialog box is displayed.

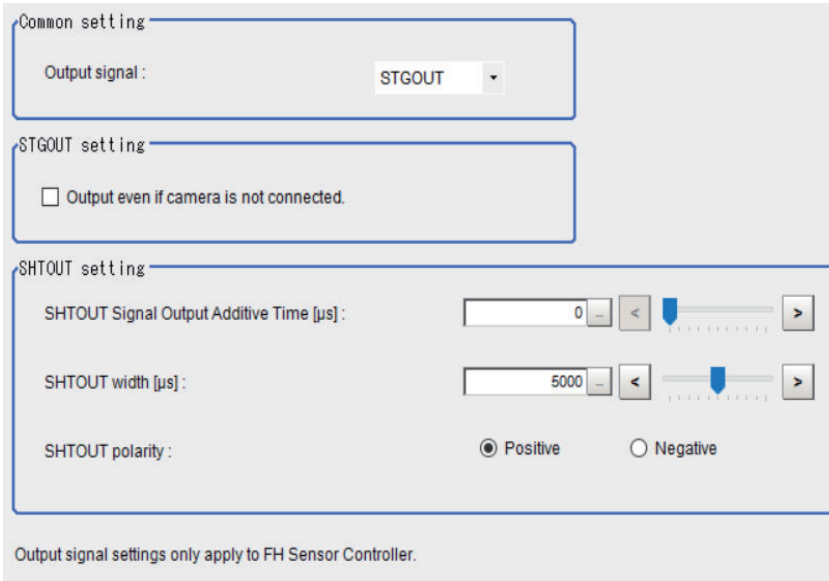

Common setting

Output signal : STGOUT

STGOUT setting

Output even if camera is not connected.

SHTOUT setting

SHTOUT Signal Output Additive Time [μs]: 0

SHTOUT width [μs]: 5000

SHTOUT polarity: Positive Negative

Output signal settings only apply to FH Sensor Controller.

- 2 Set the SHTOUT signal in the *SHTOUT setting* area.

Setting item	Setting value [Factory default]	Description
SHTOUT signal output additive time [μs] *1	0 to 1,000 [0]	Sets the delay time until the SHTOUT signal turns ON after exposure is completed in 10 [μs] increments.
SHTOUT width [μs]	40 to 10,000 [5,000]	Sets the SHTOUT signal output time in 10 [μs] increments.
SHTOUT polarity	<ul style="list-style-type: none"> • [Positive] • Negative 	Sets the pulse polarity of the SHTOUT signal. Positive: The SHTOUT signal turns ON when exposure is completed. Negative: The SHTOUT signal turns OFF when exposure is completed.

*1. This item name is changed from Ver. 6.60. This item name is SHTOUT signal delay [μs] in old model.

- 3 Click **Apply**.



Precautions for Correct Use

- If more than one Camera is connected, the SHTOUT signal will remain ON for the Camera with the longest exposure time.
- You cannot use the Shutter Output (SHTOUT) signal when the image mode is set for *Through image*.
- If you have registered more than one Camera Image Input processing unit in the measurement flow, the SHTOUT signal will be turned ON for each Camera Image Input processing unit individually.
- The SHTOUT signal will be output for as many times as imaging is performed when Camera Image Input HDR or Camera Image Input HDR Lite processing item is used.
- The SHTOUT signal that is output through EtherCAT communications is affected by this setting.

Communications Specifications Settings

Use the following procedure to select the type of output control, set the output signal operation, and set other parallel interface communication specifications.

- 1 On the Main Window, select **Tool - System Settings - Communication**.
- 2 Select **System Settings - Communication - Parallel** from the tree view on the left. The Parallel View is displayed.
- 3 Click **Setting** to set the communication specifications.

Setting	Confirmation
Judge output polarity:	ON at NG
Error output polarity:	ON at error
Output control :	None
Output period [ms] :	10.0
Gate ON delay [ms] :	1.0
Output time [ms] :	5.0
Timeout [s] :	10.0
Number of delay :	1
<input type="checkbox"/> One-shot OR signal	
Output time [ms] :	5.0

- 4 Set each item.

Setting item	Set value [Factory default]	Description
Judge output polarity*1	<ul style="list-style-type: none"> • ON at OK • [ON at NG] 	<p>Sets the polarity of the judgment result output signal.</p> <p>This applies to the Overall Judgement (OR) Signal and Parallel Judgment Output (DO0 to DO15). The Polarity of the Parallel Judgment Output (DO0 to DO15) can also be set for each Parallel Judgment Output Processing Unit.</p> <p>For details, refer to <i>Registering Parallel Judgment Output Items</i> on page 2-375.</p> <p>ON at OK: ON when the judgment result is OK. For the overall judgment, ON when all judgment results are OK.</p> <p>ON at NG: ON when the judgment result is NG. For the overall judgment, ON when one of the judgment results is NG.</p>
Error output polarity	<ul style="list-style-type: none"> • [ON at error] • ON when an error occurs. 	<p>Sets the polarity of the error output signal.</p> <p>ON at error: ON when an error occurs.</p> <p>OFF at error: OFF when an error occurs.</p>
Output control	<ul style="list-style-type: none"> • [None] • Handshaking • Synchronization output 	<p>When outputting data, set whether or not to synchronize with external equipment.</p> <p>None: The Sensor Controller outputs measurement results without synchronizing with external devices. For details, refer to <i>Output Control: None</i> on page 2-403.</p> <p>Handshaking: The Sensor Controller outputs measurement results with synchronizing with external devices. For details, refer to <i>Output Control: Handshaking</i> on page 2-404.</p> <p>Synchronization output: Measurement results are output while synchronizing with processing timing on the line. The STEP signal is ignored the number of times set in <i>Number of delays</i>, and measurement results are output when the STEP signal turns ON next time. When Through image has been selected, synchronization output cannot be used. For details, refer to <i>Output Control: Synchronization Control</i> on page 2-406.</p>

Setting item	Set value [Factory default]	Description
Output period [ms]	2.0 to 5,000.0 [10.0]	Valid only when <i>Output control</i> is set to <i>None</i> . Set the cycle by which measurement results are output. Set the timing of the Parallel Judgment Output (DO0 to DO15). Sets the cycle so that the interval is equal to or longer than <i>Gate ON delay</i> + <i>Output time</i> and shorter than measurement interval. If the cycle were longer than the measurement interval, output timing will be delayed while measurement is being repeated.
Gate ON delay [ms]	1.0 to 1,000.0 [1.0]	Sets the time from when results are output to the parallel interface to when the GATE signal turns ON. This is a waiting time until data output is stable. Set this so that it is longer than the external device delay time.
Output time [ms]	1.0 to 1,000.0 [5.0]	Valid only when <i>Output control</i> is set to <i>None</i> . Sets the GATE signal ON time. Set the time required for external devices to acquire measurement results.
Timeout [s]	0.5 to 120.0 [10.0]	Valid only when <i>Output control</i> is set to <i>Handshaking</i> . A timeout error occurs when no response from external devices is received at the following timing within the time that has been set. <ul style="list-style-type: none"> When the DSA signal turns ON after measurements are completed When the DSA signal turns OFF after the GATE signal turns ON When the DSA signal turns ON after the GATE signal turns OFF When signals from DI0 to DI6 and DI7 are used to execute a command, if the time until the DI7 signal turns OFF after the ACK signal turned ON exceeded the set timeout interval.
Number of delays	1 to 15 [1]	Valid only when the <i>Output control</i> parameter is set to <i>Synchronized output</i> . Sets how many times the STEP signal is ignored until the measured results are output after the STEP signal is turned ON.

Setting item	Set value [Factory default]	Description
One-shot OR signal	<ul style="list-style-type: none"> • ON • [OFF] • Output time 	<p>ON: When the judgment output ON condition is satisfied after the measurement results are finalized, the OR signal is turned ON for the time set at the <i>one-shot output time</i>. It is then turned OFF after the specified time has elapsed.</p> <p>OFF: The judgment is output after measurement results are finalized. the ON/OFF state of the OR signal is held until it is changed by the next measurement result.</p> <p>Output time: Sets the ON time for the OR signal after one-shot was output. (Setting range: 0.1 to 1000.0 [ms])</p>

*1. For Parallel Judgment Output, you can change the output polarity of each Parallel Judgment Output unit regardless of the value of this setting.

For details, refer to *2-6-5 Output Data Settings (Processing Item Registration)* on page 2-371.



Precautions for Correct Use

Set the OR one-shot output time in the following range:

External device OR signal read period (cycle time) – 1.0 [ms] < OR one-shot output time < Measurement trigger interval(measurement takt time) – 0.5 [ms]

5 Click **Apply**.

The settings are confirmed and the Parallel View closes.

2-6-5 Output Data Settings (Processing Item Registration)

Set the data to output with parallel communications.

Parallel Judgment Output or Parallel Data Output can not available in the FHV series. When you set output data in the FHV series, refer to *2-6-6 Output Data Settings (Numerical value/Judgment)* on page 2-378.

The following three types of data can be output with parallel communications:

- OR signal
- Parallel judgment output
- Parallel data output



Additional Information

- The OR signal is output only when the *Output* option is selected.
- To perform Parallel Judgment Output or Parallel Data Output, you must register an Output Unit in the measurement flow and set the required output details.
- If you control from three to eight lines in *Multi-line Random-trigger Mode*, you cannot use Parallel Judgment Output or Parallel Data Output.

Data Output by Output Data Type

● OR Signal

This signal outputs the overall judgment.

You can determine the overall judgment by monitoring the status of the OR signal.

After the measurement results are established, the OR signal will be output only when the overall judgment is NG and the *Output* option is selected.

You can also set the signal to be output when the overall judgment is OK.

For details, refer to *Setting the Output Signal Specifications* on page 2-364.



Additional Information

The overall judgment gives the results of more than one processing item. As a result, the overall judgment will be NG if even one of the individual judgment results is NG.

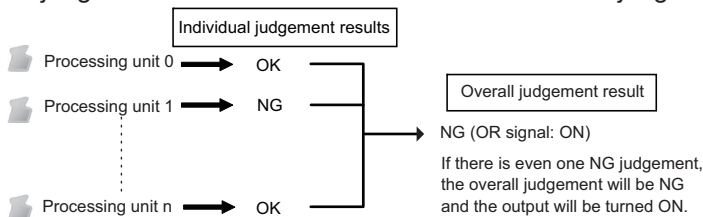

● Parallel Data Output

The measured values of processing items or the calculation results of expressions are output. Data items can be set from data 0 to data 7. Each item is output using the 16 bits from DO0 to DO15.

The data output specifications are as follows:

- Only integer portion is output. Fractional digits are rounded off.
- The range of values that can be output is as follows:

Binary format: -32,768 to +32,767

BCD format: -999 to +999

If the measurement value is out of range, the actual measurement value is not output and the minimum or maximum value within the range is output instead.

Data type	Measurement value that is below the possible output range	Measurement value that is above the possible output range
Binary	A value of -32,768 is output.	A value of +32,767 is output.
BCD	A value of -999 is output.	A value of +999 is output.



Additional Information

When the operation mode is set to *Multi-line Random-trigger Mode*, the parallel data output range is between -127 and 127 for binary data, and -9 and 9 for BCD data.

● Parallel Judgment Output

The measured values of the processing items or calculation results are judged and the judgment results are output.

Judgment results can be set from judgment 0 to judgment 15. Each result is output from DO0 to DO15.

Setting Up Parallel Data Output

The measured values of processing items or the calculation results of expressions are output.

● Registering Parallel Output Units

Register the processing items for data output in the measurement flow.

- 1 Click **Edit flow** in the Toolbox Pane.
- 2 Select the **Parallel Data Output** processing item from the processing item tree.

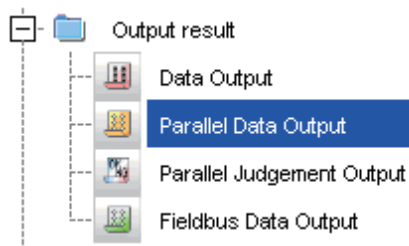

- 3 Click **Append**.
The **Parallel Data Output** processing item is appended at the bottom of the unit list (flow).

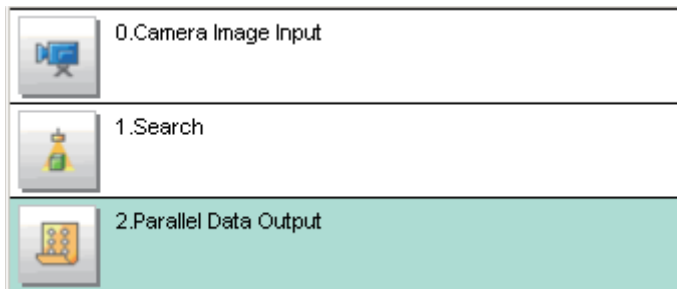

Additional Information

Data is output in the order that Output Units are registered in the measurement flow, i.e., the timing is different for each data output processing unit. (Data output is executed in the order that it is executed in the measurement flow.)

● **Set the items to output**

In an expression, set the data to output (i.e., the measured value of a processing item or the calculation results of an expression).

Up to 8 expressions from 0 to 7 can be set in each unit.

- 1 Click the Parallel Data Output icon .
- 2 In the Item tab area, click **Setting**.
- 3 In the list, click the output data number to set the expression.

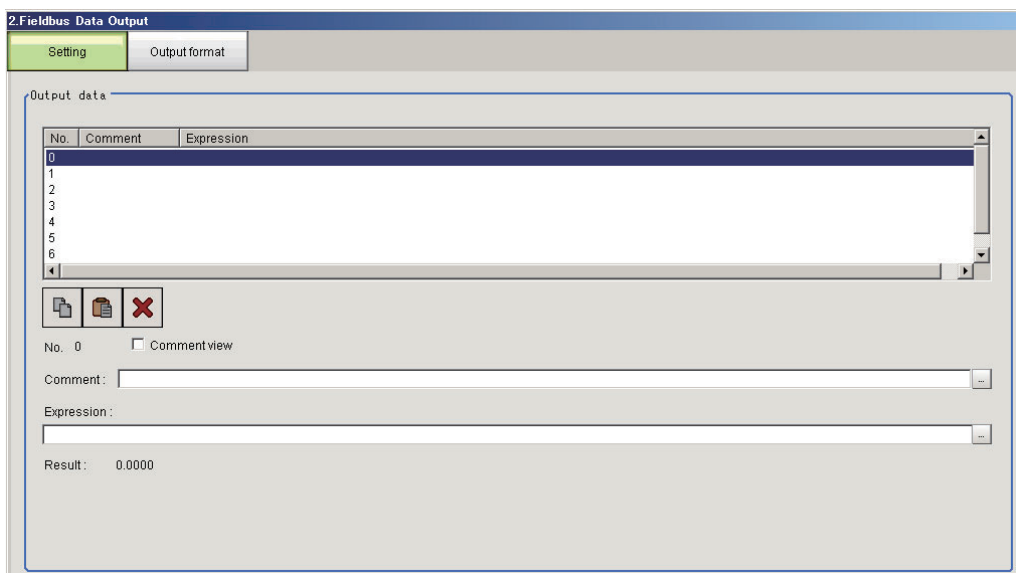

The selected output data number is displayed under the list.

- 4 Click  next to the expression text box and set the expression.



Specify the processing items, measurement results, and measurement data in the expression. Arithmetic or function calculations can be applied to the measurement data to output.

For details of the calculation settings, refer to *Calculation* in the *Vision System FH/FHV Series Processing Items Reference Manual (Cat. No. Z341)*.

- 5 Click  for the **Comment** text box and enter the description for the expression. The entered comment will be displayed in the detailed results area on the Main window. For example, *Test* was entered as the comment for the expression 0, *Test* will be displayed instead of *Expression 0* in the detailed results areas on the Main window.
- 6 Repeat step 3 to 5 to set expressions for all of the required output data numbers.



Additional Information

Output When Multiple Items Are Set

The items that are set for output data numbers 0 through 7 are output to the PLC reception buffer in ascending order, one data item at a time (16-bit units). Each time a data item is output, the GATE signal turns ON.*1

When this occurs, the first data item that was output to the external device such as a PLC reception buffer (data 0) is overwritten by the next output data item (data 1).

Therefore, the data output to the external device such as a PLC reception buffer must be saved to external device memory each time the GATE signal turns ON for each data item.

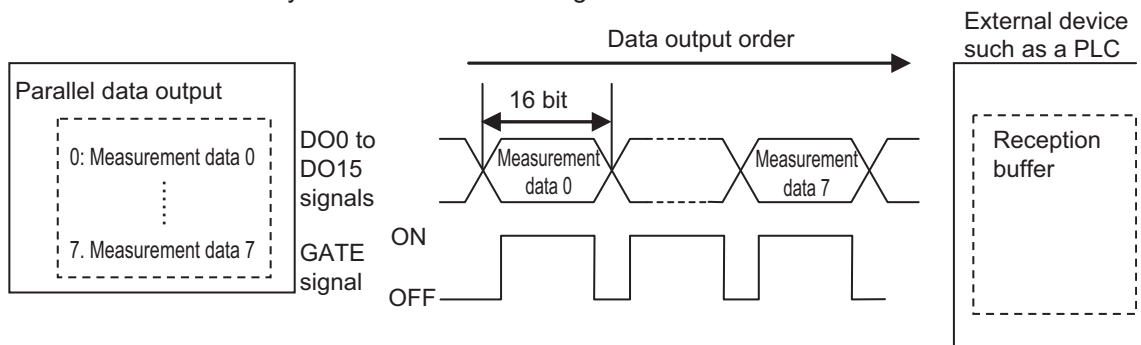

*1: The operation of the DSA signal depends on whether handshaking for output control is enabled.

For details, refer to *Data Output Control with Handshaking* on page 1-24.

● **Output Format (Parallel Data Output)**

- 1 Click the **Parallel Data Output** icon  in the measurement unit list (flow).
- 2 In the item tab area, click **Output format**.
- 3 Select the **output format** in the output settings.

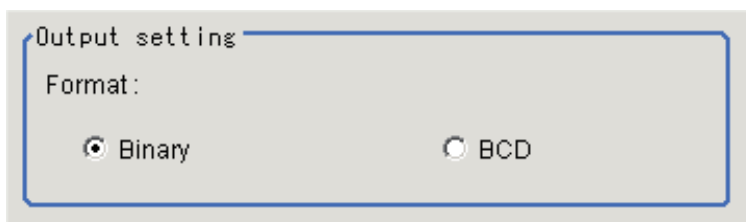

Setting item	Setting value [Factory default]	Description
Output format	[Binary]	Data is output as 2's complement binary data. Information on 2's Complement: For details, refer to <i>Definitions of Basic Terms</i> in the <i>Vision System FH/FHV Series User's Manual (Cat. No. Z365)</i> .
	BCD	Data is output expressing 1 digit with 4 bits and expressing a 3-digit integer and sign with 16 bits. <ul style="list-style-type: none"> • Bits 12 to 15 These bits give the sign. (positive: 0000, negative: 1111) • Bits 0 to 11 Every 4 bits express 1 digit from ones place (bits 0 to 3: 1st digit) to the hundreds place (bits 8 to 11: 3rd digit).

Registering Parallel Judgment Output Items

Use the following procedure to output the judgment results that are set for parallel output.

● Registering Parallel Judgment Output Items

Use the following procedure to output the judgment results that are set for parallel output.

- 1 Click **Edit flow** in the toolbar or on the Main Window.
- 2 Select the **Parallel Judgement Output** processing item from the processing item tree.

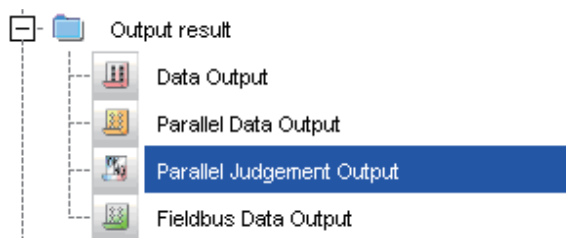

- 3 Click **Append**.
The **Parallel Judgment Output** processing item is appended at the bottom of the unit list (flow).

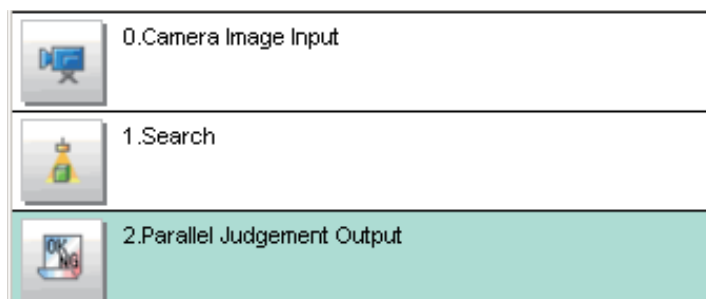

Additional Information

Data is output in the order that Output Units are registered in the measurement flow, i.e., the timing is different for each data output processing unit. (Data output is executed in the order that it is executed in the measurement flow.)

● Registering the Items To Output

In an expression, set the target for judgment (i.e., the measured value of a processing item or the calculation result of an expression).

Up to 16 expressions from 0 to 15 can be set in each unit.

- 1 Click the **Parallel Judgment Output** icon  in the measurement unit list (flow).
- 2 In the Item tab area, click **Setting**.
- 3 In the list, click the output data number to set the expression.

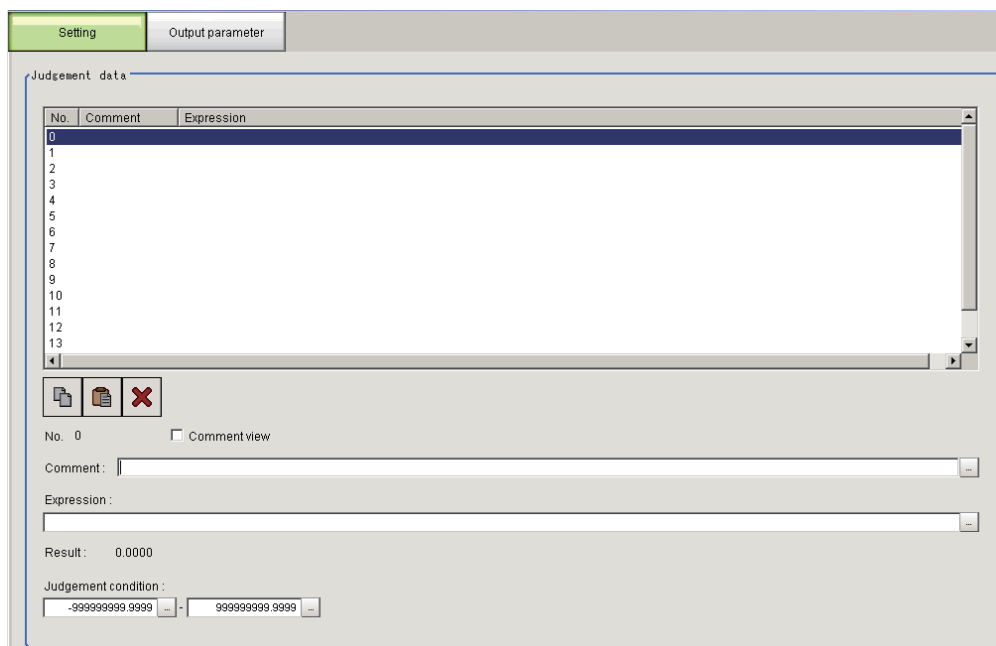

The selected output data number is displayed under the list.

- 4 Click  next to the expression text box and set the expression.



Specify the processing items, measurement results, and measurement data in the expression. Arithmetic or function calculations can be applied to the measurement data to output.

For details of the calculation settings, refer to *Calculation* in the *Vision System FH/FHV Series Processing Items Reference Manual (Cat. No. Z341)*.

- 5 Click the  button for the judgment condition, and then set the upper and lower limits to judge as OK.
If the result data set in step 4 above is within the range set here, the result will be judged as OK.

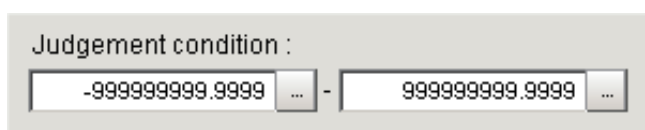

- 6 Click  for the **Comment** text box and enter the description for the expression.

7 Repeat steps 4 and 5 to set expressions for all of the required output data numbers.

● **Output Parameters (Parallel Judgment Output)**

1 Click the **Parallel Judgment Output** icon  in the measurement unit list (flow).

2 Click **Output parameter** in the Item Tab Area.

3 Set the items in the output settings area.

Setting item	Setting value [Factory default]	Description
Output polarity	<ul style="list-style-type: none"> • [System (parallel)] • Unit 	Selects System (parallel) or Unit to set the output polarity.
System (parallel)	-	Select when you want to match the output polarity of the evaluation result to the system setting.
Unit	<ul style="list-style-type: none"> • [ON at NG] • ON at OK 	Select when you want to set the output polarity of the evaluation result per processing unit. <ul style="list-style-type: none"> • ON at NG: Outputs when the judgment result is NG. • ON at OK: Outputs when the judgment result is OK.

4 For **Reflect to overall judgment**, select whether to apply this processing unit's evaluation result to the overall evaluation of the scene.

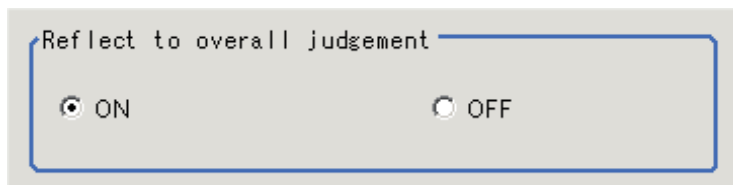

Setting item	Setting value [Factory default]	Description
Reflect to overall judgment	<ul style="list-style-type: none"> • [ON] • OFF 	Select whether the judgment results of this processing unit is reflected in the scene overall judgment.

2-6-6 Output Data Settings (Numerical value/Judgment)

Registering Processing Items

Register the processing items for data output in the measurement flow.

- 1 In the Main window, click **Edit flow** in the Toolbox Pane.
- 2 Select **Result output (Parallel I/O)** from the processing item tree.

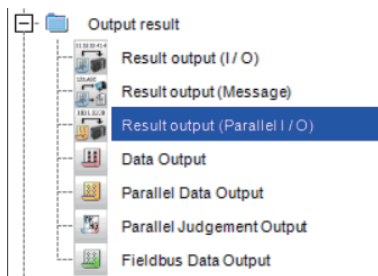

- 3 Click **Append**.
The **Result output (Parallel I/O)** is appended at the bottom of the unit list (flow).

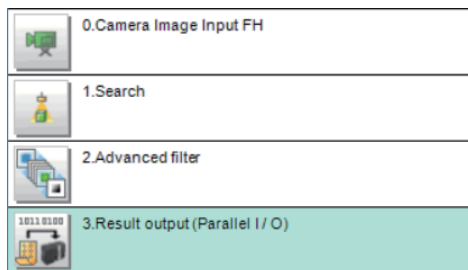

- 4 Click the icon  of **Result output (Parallel I/O)** in the unit list (flow) or **Set** to set the output data.

Setting the Output Data

Configure the object to output with the parallel interface.
data to output with the parallel I/O in 256 times can be set.

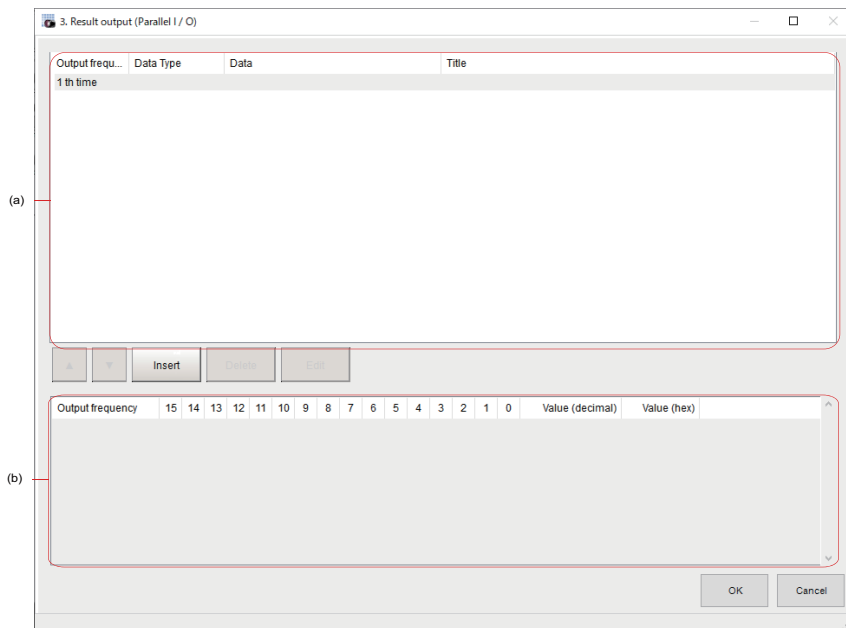

- a. Setting data display area
Display the waiting number of times until output, Data type (integer or judgment), Data, Title (data description).
- b. Output data display area
Display data to output. Each of 0 to 15 corresponds to the output result for each of DO0 to DO15 terminal. The value is checked with decimal or hex format.

Button	Description
	Moves the selected data up one position.
	Moves the selected data down one position.
	Adds new data to the selected data position.
	Deletes the selected data. the following data moves up after that.
	Edits the selected data.

- 1 Click *Insert*.
The following *Output data editing* dialog box is displayed.

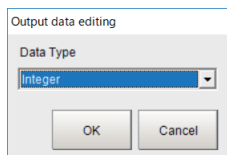

- 2 In the *Output data editing* dialog, set data to output.
For each data settings of integer and judgment, refer to *Setting for Integer Output* on page 2-380 and *Setting for Judgment Output* on page 2-381.
- 3 Repeat step 1 to 2 for the number of data to output.
Clicking data set in the *Setting data display* area emphasizes the corresponding output data on the area.



Precautions for Correct Use

When the operation mode is set to Multi-line Random-trigger mode, the displayed content on the *Output data display* area differs from the actual signal to be output.

When the number of lines is two, all output status for DO0 to DO15 is displayed on the *Output data display* area. However, the actual data to be output on line 0 is displayed on DO0 to DO7 terminals and output as it is.

Although the actual data to be output on line 1 is also displayed on DO0 to DO7, they are actually output on DO8 to DO15.

In the *Output data display* area, the lower 16 bits of the integer (32 bits) are output, and the upper 16 bits are not output. It is displayed as a 32 bit. The setting value is accepted in the range of integer type (-2,147,483,647 to 2,147,483,647).

Either of the following rules must be specified on the recipient side (PLC) and the feed side (FH) and used within these rules.

- Use as unsigned from 0 to 65535
- Use as signed from -32,767 to 32,767

● Setting for Integer Output

- 1 In the *Output data editing* dialog, select *Integer* and then click **OK**.

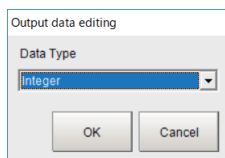

- 2 Specify an integer to output using a variable or direct input.

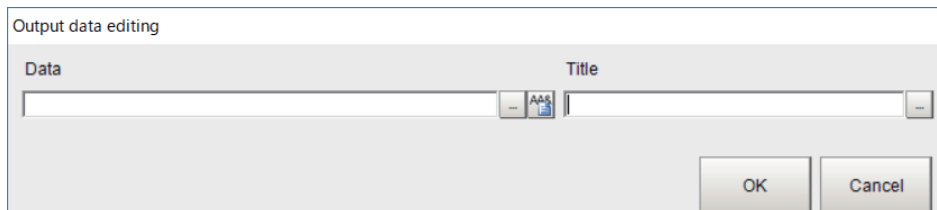

Setting item	Setting value [Factory default]	Description
Data	-	Sets data to output. The following two setting methods are available.*1 <ul style="list-style-type: none"> • Directly enter an integer with a character string. • Assign a variable.
Title	-	Sets the description for the set item with character strings. The character strings set here is displayed on the Title column in the <i>Setting data display</i> area. Multilingual input is also available. For details, refer to <i>Inputting Text</i> in the <i>Vision System FH/FHV Series User's Manual</i> (Cat. No. Z365).

*1. If character strings instead of numeric values or variables are set, the display on the *Output data display* area will not be done properly. Enter a numeric value or variable with alphanumeric properly.



Precautions for Correct Use

- When *data* is a real number, the rounded value will be output.
- If the value of *data* exceeds the range to be expressed with the parallel I/O terminals, the overflowed values will be ignored to output.

● Setting for Judgment Output

1 In the *Output data editing* dialog, select *Judgment* and then click **OK**.

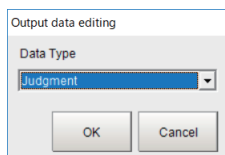

2 Specify the output polarity and judgment condition to assign to each terminal of the parallel interface.

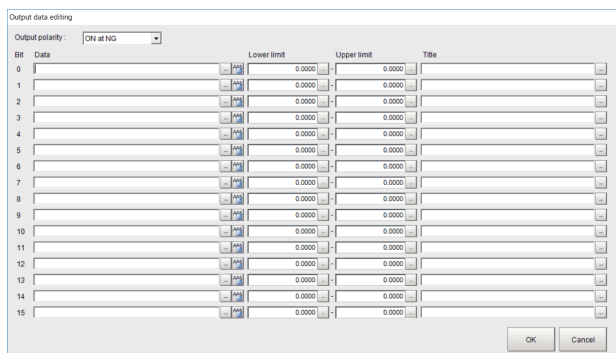

Setting item	Setting value [Factory default]	Description
Output polarity	<ul style="list-style-type: none"> • [ON at NG] • ON at OK 	Sets the polarity of signal output for the judgment result. <ul style="list-style-type: none"> • ON at NG: ON when the judgment result is NG. • ON at OK: ON when the judgment result is OK. The polarity for the signal output in this processing item does not reflect the setting of the Output polarity in the System settings but follows the setting here.
Data	-	Sets data to judge. <p>The following two setting methods are available.*1</p> <ul style="list-style-type: none"> • Directly enter an integer with a character string. • Assign a variable.
Judgment condition Lower limit and upper limit values	-999,999,999.9999 to 999,999,999.9999 [0.0000] to [0.0000]	Sets the range between the lower and upper limits for the judgment. <p>When a value set in the <i>Data</i> is within the range set here, it is judged as OK.</p>

Setting item	Setting value [Factory default]	Description
Title	-	Sets the description for the set item with character strings. A character string set in Bit 0 will be displayed on the Sets the description for the set item with character strings. Multilingual input is also available. For details, refer to <i>Inputting Text</i> in the <i>Vision System FH/FHV Series User's Manual</i> (Cat. No. Z365).

- *1. If character strings instead of numeric values or variables are set, the display on the *Output data display* area will not be done properly. Enter a numeric value or variable with alphanumeric properly.

2-6-7 Testing Communications

Use the following procedures to check the communications status with the external devices connected with a parallel interface. You can check whether wiring and communications settings have been performed correctly.

- 1 On the Main Window, select **Tool - System Settings - Communication**.
- 2 Select **System Settings - Communication - Parallel** from the tree view on the left. The Parallel View is displayed.
- 3 Click **Confirmation** to check the I/O status.

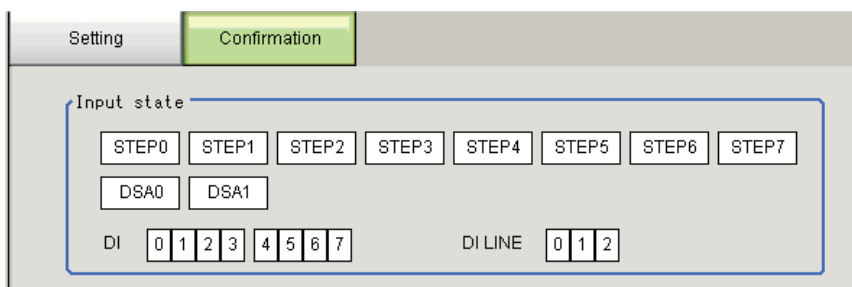

Setting item	View	Description
Input state	STEP0 to STEP7 Only the settings for STEP0 and STEP1 are valid for an Sensor Controller of the FZ5-800/1100/1200 series.	The input status of each signal from the external device to the Sensor Controller is displayed. When a signal is input, the background color turns into red.
	DSA0, DSA1	
	DI0 to DI7	
	DI LINE0 to DI LINE2 Valid only for an FH-2000 / FH-5000 series Sensor Controller.	
Output state	RUN	The output status of each signal is displayed. When a signal is output, the background color turns into red.
	ERR	
	BUSY	The output status from each signal of the Sensor Controller to external devices can be specified. Changes between ON and OFF and between 0 and 1 can be simulated without performing measurement.
	OR	
	GATE	
	READY	
	ACK	
DO0 to DO15		

- 4 Change the contents to be sent.

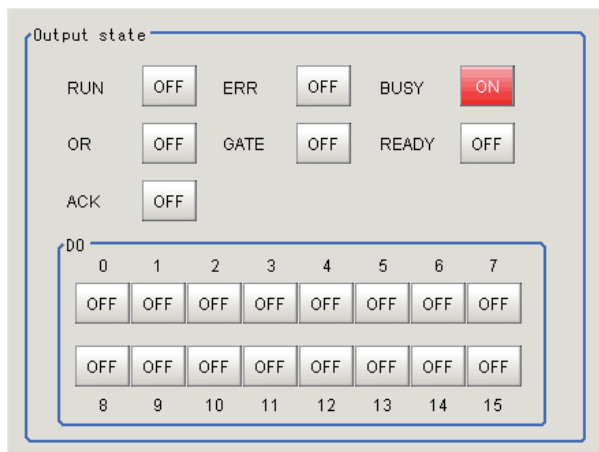

Each time *ON* and *OFF* are switched, the changed contents are displayed on the monitors of external devices. Make sure there are no problems.

5 Click **Close**.

2-6-8 I/O Signals

The following tables list the signals that are used to control I/O for parallel communications.

Input Signals

Signal	Signal name	Function	ON/OFF timing	
			OFF to ON	ON to OFF
STEP	Measurement Trigger Input signal	Input measurement triggers from external devices, such as optic switches. Measurement is performed once by synchronizing with the STEP signal rising (OFF to ON). In STEP input, a STEP signal filter (filter initial set value: 100 [μ s]) has been set.	Switch from OFF to ON (rising) to perform a measurement.	Switch from ON to OFF when the user (PLC) detected that the Sensor Controller turns the BUSY signal ON.
DSA (Used only for hand-shaking output control.)	Data Output Request signal	This is a signal that the user (PLC) requests the Sensor Controller to externally output data executed in the measurement flow at hand-shaking. When this signal turns ON while an Output Unit (Parallel Data Output Unit) is executed in the measurement flow, the Sensor Controller will output the data of the processing item.	Turn ON the signal when the user (PLC) want to output the data externally. Turn the DSA signal ON when the STEP signal is turned ON. If more than one output item is set in a single Output Unit, or if more than one Output Unit is set in the measurement flow, turn the DSA signal ON again when the GATE signal turns OFF for the first data output. For details, refer to <i>2-6-11 Time Charts</i> on page 2-403.	Turn OFF the signal when the user (PLC) detected that the Sensor Controller turns ON the Result Completion (GATE) signal.
DI0 to DI7	Command Input signals	Input commands from the external device.	-	-
DILINE0 to DILINE2 (Sensor Controllers of the FH-2000 / FH-5000 series only)	Command Input Line Specification signals	Specify the line number when inputting a command from an external device. Available in Multi-line Random-trigger Mode	-	-
ENC (Phase A, B, or Z)	Encoder Input (Phase A, B, or Z)	This is the encoder input signal. Valid only when <i>Use Encoder trigger</i> is set in the system settings.	-	-

Output Signals

Signal	Signal name	Function	ON/OFF timing	
			OFF to ON	ON to OFF
RUN	Measurement Mode Signal	This signal indicates whether or not the Sensor Controller is in RUN mode.	Turn ON when the Sensor Controller is in Run Mode, which means that the Sensor Controller is in the measurable status and RUN signal output in Layout settings is checked.	The signal turns OFF in either of the following cases: <ul style="list-style-type: none"> • In ADJUST Mode. • When the Sensor Controller cannot perform measurement. • RUN signal output is unchecked in the current Layout settings.
BUSY	Busy signal	This signal indicates when external inputs such as commands cannot be accepted. Make sure this signal is OFF before you request a command. While this signal is ON, no commands will be accepted even if they are sent. Note: <ul style="list-style-type: none"> • A command received through any other protocol is in execution, which is also detectable. • ON of this signal does not mean that a command is in execution. 	Turn ON when The Sensor Controller receives a command from the user (PLC). (The signal turns ON after the EXE signal turned ON.)	Turn OFF when the user (PLC) turns OFF the Command Request (EXE) signal.

Signal	Signal name	Function	ON/OFF timing	
			OFF to ON	ON to OFF
OR	Overall Judgment signal	<p>Output the overall judgment.</p> <p>This is determined when the measurement is completed (BUSY signal ON to OFF).</p> <p>Note:</p> <ol style="list-style-type: none"> 1. The <i>Output polarity</i> setting determines whether this signal turns ON when the judgment result is OK or NG. For details, refer to <i>Setting the Output Signal Specifications</i> on page 2-364 . 2. The OR signal is output only when the <i>Output</i> option is selected in the Adjustment Window. 	Turn ON based on the judgment results when measurement is completed. (i.e., when the BUSY signal turns OFF.)	<p>The status of the OR signal is maintained until the next OR signal is output.</p> <p>You can set the one-shot output settings so that the OR signal turns OFF automatically after a set time passed.</p> <p>You can also turn OFF the OR signal by executing the Clear Parallel OR+DO command.</p>
DO0 to DO15	Data Output signals	These signals output the results for expressions set for a Parallel Judgement Output or Parallel Data Output Output Unit.	-	-

Signal	Signal name	Function	ON/OFF timing	
			OFF to ON	ON to OFF
GATE	Data Output Completion signal	<p>This signal indicates the timing to load the output data from DO0 to DO15 to the User (PLC Link). This signal is ON, which means that the data is output from the Sensor Controller.</p> <p>The user (PLC) reads the data when this signal turns ON.</p> <p>Depending on the measurement flow settings, the GATE output may start while the BUSY signal is ON.</p> <p>Note that the OR signal does not necessarily work together with the GATE signal.</p>	<ul style="list-style-type: none"> • No Handshaking: Turn ON when the Sensor Controller of the FH/FHV series executes the Output Unit (Parallel Data Output Unit or Parallel Judgement Output Unit) in the measurement flow*1 and preparations for data output have been completed. • Handshaking: Turn ON when the Sensor Controller of the FH/FHV series executes the Output Unit (Parallel Data Output Unit or Parallel Judgement Output Unit) in the measurement flow*1*2, the Data Output Request (DSA) signal is ON, and preparations for data output have been completed. <p>*1: This occurs when the Output Unit is executed as the measurement flow is executed in order from the top. It does not occur when execution of a measurement is completed.</p> <p>*2: The signal is output if a Parallel Judgement Output or Parallel Data Output processing item is set in the measurement flow.</p>	<ul style="list-style-type: none"> • No Handshaking: The signal turns OFF after the set output time has elapsed. • Handshaking: The signal turns OFF when the user (PLC) turns OFF Data Output Request (DSA) signal.

Signal	Signal name	Function	ON/OFF timing	
			OFF to ON	ON to OFF
READY	Ready signal	<p>This signal indicates when the STEP signal can be input.</p> <p>Turn ON the STEP signal when the READY signal turns ON.</p> <p>When using the Multi-input function, the next STEP signal is accepted only after the READY signal turns ON (i.e., when image input has been completed).</p> <p>Note:</p> <p>When you use a Camera-mount Lighting Controller, the time required for the READY signal to turn OFF may increase in comparison with not using it.</p> <p>For details, refer to Camera Image Input FH or Camera Image Input HDR in the <i>Vision System FH/FHV Series Processing Items Reference Manual (Cat. No. Z341)</i>.</p>	Turn ON when the STEP signal can be input.	<p>Turn OFF when the STEP signal cannot be input.</p> <p>Note:</p> <p>When <i>Through image</i> are being displayed, the READY signal will turn OFF, but the STEP signal can be input. Determine whether or not the STEP input is acceptable based on the BUSY signal.</p>

Signal	Signal name	Function	ON/OFF timing	
			OFF to ON	ON to OFF
SHTOUT	Shutter Output signal	<p>This signal indicates when Camera exposure has been completed. This signal is output only when <i>SHTOUT</i> is selected as the output signal in the output signal settings of the system settings.</p> <p>Note:</p> <ul style="list-style-type: none"> • If more than one Camera is connected, the signal will remain ON for the Camera with the longest exposure time. • You cannot use the Shutter Output Signal when the image mode is set for <i>Through image</i>. • If you have registered more than one Camera Image Input processing unit in the measurement flow, the SHTOUT signal will be turned ON for each Camera Image Input processing unit individually. Therefore, use Camera Switching processing items instead of Camera Image Input processing items in the middle of the measurement flow. 	After the Camera exposure is completed, the signal turns ON after the time set for the SHTOUT signal output additive time in the output signal settings has elapsed.	The signal turns OFF after the time set for the SHTOUT width in the output signal settings has elapsed.
STGOUT	Strobe Trigger Output	This is the trigger signal for the strobe.	After an external trigger input is received, the signal turns ON after the time set for the STGOUT output addition time in the electronic flash settings has elapsed.	The signal turns OFF after the time that is set for the STGOUT width in the electronic flash settings has elapsed.
ACK	Command Completion Flag	This flag indicates when DI command execution is completed.	Turn ON when execution of the DI command is completed	Turn OFF when the user (PLC) turns OFF the DI7 signal.

Signal	Signal name	Function	ON/OFF timing	
			OFF to ON	ON to OFF
ERR	Error Signal	This signal indicates when the Sensor Controller detects errors. For details of the errors, refer to <i>Error Messages and Troubleshooting in the Vision System FH/FHV Series User's Manual (Cat. No. Z365)</i> .	It will turn ON in any of the following cases. <ul style="list-style-type: none"> • Turn ON when the Sensor Controller detects an error. • Turns ON when a STEP signal is input while the READY signal is OFF. • Turns ON when a command which does not exist is issued. 	Regardless of the OFF to ON condition set, it will turn OFF in any of the following cases. <ul style="list-style-type: none"> • When the user (PLC) issues Error Clear (ERCLR signal: ON) command after the error is removed, • When the STEP signal is input while the READY signal is ON • When a valid command is issued

Multi-line Random-trigger Mode Signal Specifications

For parallel signals, the supported signal types and signal assignments depend on the number of lines used in *Multi-line Random-trigger Mode*.

The following tables show the differences in signal assignments and the signal types that can be used depending on the number of lines.

For details of terminal functions and assignments, refer to *Parallel interface in the Vision System FH series Hardware Setup Manual (Cat. No. Z366)*.

● FH-2000 / FH-5000 series Sensor Controller

• Signals and Assignments According to Number of Lines Used

I/O	Number of lines			
	1 line	2 lines	3 or 4 lines	5 to 8 lines
STEP	Assigned for each line.			
DSA	Assigned for each line.		Not supported.	
DI	The same signal is used for all lines.	The same signal is used for all lines. The DILINE signal (which specifies the line number to send the command) is added.		
ENC (Phase A, Phase B, or Phase Z)	Assigned for each line.			
ACK	The same signal is used for all lines.			
RUN	Assigned for each line.			Not supported.
GATE	Assigned for each line.		Not supported.	
BUSY	Assigned for each line.			
OR	Assigned for each line.			
ERR	Assigned for each line.			The same signal is used for all lines.
READY	Assigned for each line.			
DO	DO0 to DO15	Line 0: DO0 to DO7 Line 1: DO8 to DO15	Not supported.	

• **Signals According to Lines Used**

Two Lines

I/O	Line number	
	Line 0	Line 1
STEP	STEP0	STEP1
DSA	DSA0	DSA1
DLINE	DLINE0 (used for all lines)	
DI	DI0 to DI7 (used for all lines)	
ENC (Phase A, B, Z)	ENC0 Phase A, ENC0 Phase B, or ENC0 Phase Z *When an encoder is used, STEP0 is assigned to ENC0 Phase Z.	ENC1 Phase A, ENC1 Phase B, or ENC1 Phase Z * When an encoder is used, STEP6 is assigned to ENC1 Phase A, STEP7 is assigned to ENC1 Phase B, and STEP1 is assigned to ENC1 Phase Z.
ACK	ACK (used for all lines)	
RUN	RUN0	RUN1
GATE	GATE0	GATE1
BUSY	BUSY0	BUSY1
OR	OR0	OR1
ERR	ERR0	ERR1
READY	READY0	READY1
DO	DO0 to DO7	DO8 to DO15

Three or Four Lines

I/O	Line number			
	Line 0	Line 1	Line 2	Line 3
STEP	STEP0	STEP1	STEP2	STEP3
DSA	-			
DLINE	DILINE 0 to DILINE 1 (used for all lines) *DSA0 is assigned to DILINE1.			
DI	DI0 to DI7 (used for all lines)			
ENC (Phase A, Phase B, or Phase Z)	-			
ACK	ACK (used for all lines)			
RUN	RUN0	RUN1	RUN2	RUN3
GATE	-			
BUSY	BUSY0	BUSY1	BUSY2	BUSY3
OR	OR0	OR1	OR2	OR3
ERR	ERR0	ERR1	ERR2	ERR3
READY	READY0	READY1	READY2	READY3
DO	-			

Five to Eight Lines

I/O	Line number							
	Line 0	Line 1	Line 2	Line 3	Line 4	Line 4	Line 6	Line 7
STEP	STEP0	STEP1	STEP2	STEP3	STEP4	STEP5	STEP6	STEP7
DSA	-							

I/O	Line number							
	Line 0	Line 1	Line 2	Line 3	Line 4	Line 4	Line 6	Line 7
DLINE	DILINE 0 to DILINE 1 (used for all lines) *DSA0 is assigned to DILINE1 and DSA1 is assigned to DILINE2.							
DI	DI0 to DI7 (used for all lines)							
ENC (Phase A, Phase B, or Phase Z)	-							
ACK	ACK (used for all lines)							
RUN	-							
GATE	-							
BUSY	BUSY0	BUSY1	BUSY2	BUSY3	BUSY4	BUSY5	BUSY6	BUSY7
OR	OR0	OR1	OR2	OR3	OR4	OR5	OR6	OR7
ERR	ERRV (used for all lines)							
READY	READY0	READY1	READY2	READY3	READY4	READY5	READY6	READY7
DO	-							

Input Timing of Input Signals

● STEP Signal Input Timing

The measurement trigger STEP signal is input with the following timing.

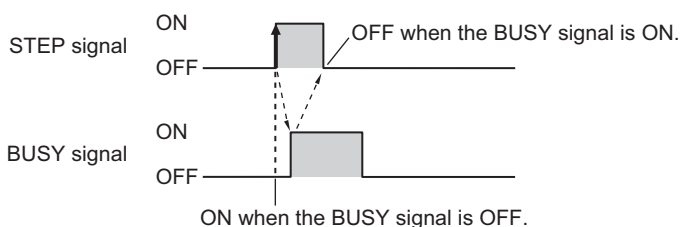

- (1) Turn ON the STEP signal when the BUSY signal is OFF.
When multiple inputs are used, the STEP signal can be turned ON when the READY signal is ON. However, when the image mode is set to *Through Mode*, the READY signal will always be OFF, so check the status of the BUSY signal to determine when to input the STEP signal.
- (2) Check that the BUSY signal is ON, then turn OFF the STEP signal.



Additional Information

If the STEP signal is turned ON when the READY signal is OFF, no measurements will be executed and the ERROR signal will turn ON.

● DI0 to DI7 (Command Execution) Timing

- FH-series Sensor Controller

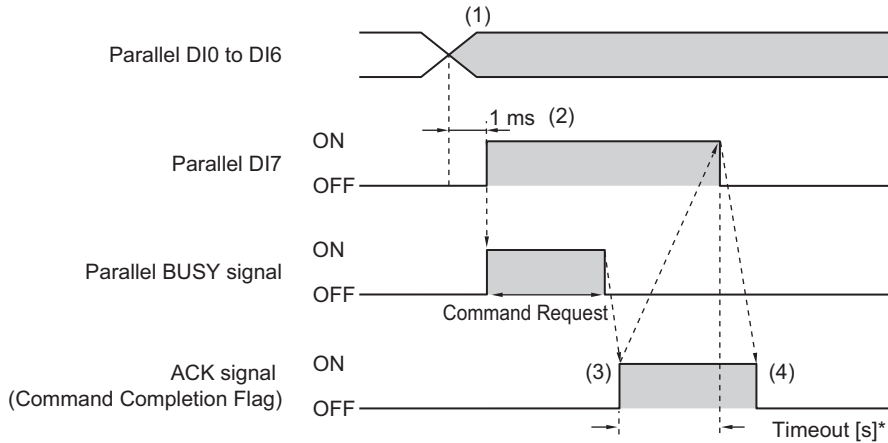

When executing continuous measurement commands, turn OFF DI7 when you want to stop continuous measurements, as shown below.
For continuous measurement commands, the ACK signal will remain OFF.

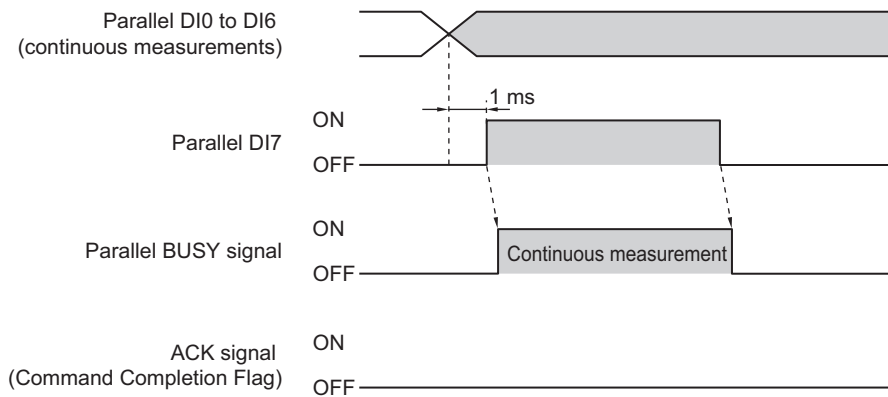

- (1) Set the DI0 to DI6 signals to ON or OFF based on the command to input.
 - (2) After you have set the DI0 to DI6 signals, wait for at least 1 [ms] and then turn ON DI7.
 - (3) The command will be executed, and the ACK signal will turn ON after execution of the command is completed.
 - (4) Check that the ACK signal has turned ON, then turn OFF DI7.
When the DI7 signal is turned OFF, the ACK signal will turn OFF.
- * A timeout error will occur if the DI7 signal is not turned OFF within the set timeout interval from when the ACK signal is turned ON.



Precautions for Correct Use

If the DI7 is still ON after execution of a command is completed, the same command will be executed again.
Confirm that the ACK signal is turned ON from OFF, and then create the program of the PLC side to turn the DI7 signal OFF from ON.



Additional Information

From the PLC, set signals DI0 to DI6 and turn ON the DI7 signal only when the BUSY, ACK, and DI7 signals are all OFF.

From the PLC, you can check if a command was acknowledged by confirming that the BUSY signal turned ON.

From the PLC, you can check if execution of a command was completed by confirming that the ACK signal turned ON.

After these conditions have all been met, turn OFF the DI7 signal.

- **FHV series (when not using the Smart Camera Data Unit (Parallel Interface) FHV-SDU10)**

Sensor control commands are input with the timing shown below using the DI0 to DI2 signals. In the FHV series, commands are executed with DI0, DI1, and DI2 signals.

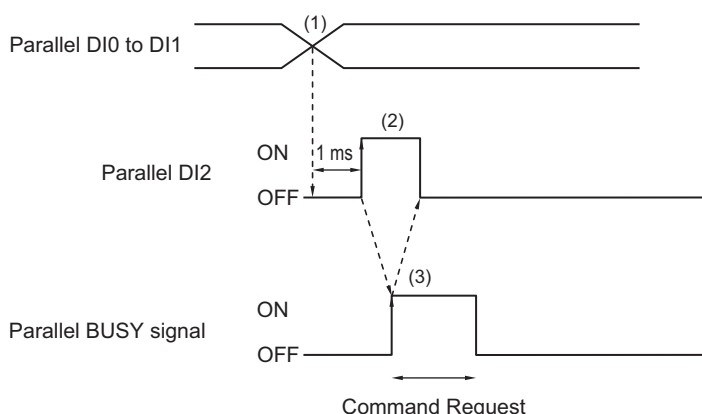

- (1) Set the DI0 to DI1 signals to ON or OFF based on the command to input.
- (2) After you have set the DI0 to DI1 signals, wait for at least 1 ms and then turn ON DI2.
- (3) Then check that the BUSY signal has turned ON, then turn OFF DI2. The BUSY signal is turned OFF when execution of the command is completed. When executing continuous measurement commands, turn OFF DI2 when you want to stop continuous measurements.



Precautions for Correct Use

If the DI2 is still ON after execution of a command is completed, the same command will be executed again.



Additional Information

From the PLC, set signals DI0 to DI1 and turn ON the DI2 signal only when the BUSY and DI2 signals are OFF.

The PLC (user) turns OFF the DI2 signal after checking that the BUSY signal has turned ON.

- **FHV series (when using the Smart Camera Data Unit (Parallel Interface) FHV-SDU10)**

Refer to the FH series Sensor Controller section.

2-6-9 Output Items

In the FHV series, this processing item is unavailable.

Parallel Data Output

This processing item can not be used in the FHV series.

● Measurement Results for Which Output Is Possible (Parallel Data Output)

You can use the processing items that are related to outputting results to output the following data. You can also access measured values from processing units such as expressions.

Measured item	Text string	Description
Judgement	JG	Judgment result
Data 0 to 7	D00 to D07	Results of expressions set for output data 0 to 7

● External Reference Tables (Parallel Data Output)

By specifying a number, the following data can be referenced from control commands or processing items that have a set/get processing unit data function.

Number	Data name	Get only	Data range
0	Judgment	Get only	0: No judgment (unmeasured) 1: Judgment result OK -1: Judgment result NG
5 to 12	Data 0 to Data 7	Get only	• BCD: -999 to 999 • Binary: -2147483.648 to 2147483.647
128	Data type	Set/Get	0: Binary 1: BCD

Parallel Judgment Output

This processing item can not be used in the FHV series.

● Measurement Results for Which Output Is Possible (Parallel Judgement Output)

You can use the processing items that are related to outputting results to output the following data. You can also access measured values from the processing units such as expressions.

Measured item	Text string	Description
Judgment	JG	Judgment result
Data 0 to 15	D00 to D15	Results of expressions set for output judgment data 0 to 15
Judge 0 to 15	J00 to J15	Results of judgment on expressions set for output judgment data 0 to 15

● External Reference Tables (Parallel Judgment Output)

By specifying a number, the following data can be referenced from control commands or processing items that have a set/get processing unit data function.

Number	Data name	Set/Get	Data range
0	Judgment	Get only	0: No judgment (unmeasured) 1: Judgment result OK -1: Judgment result NG
5 to 20	Data0 to Data 15	Get only	-999,999,999.9999 to 999,999,999.9999
21 to 36	Judge 0 to Judge 15	Get only	0: No judgment (unmeasured) 1: Judgment result OK -1: Judgment result NG
103	Reflect to the overall judgment	Set/Get	0: ON, 1: OFF
136	Upper limit 0 for judgment	Set/Get	-999,999,999.9999 to 999,999,999.9999
137	Lower limit 0 for judgment	Set/Get	-999,999,999.9999 to 999,999,999.9999
138	Upper limit 1 for judgment	Set/Get	-999,999,999.9999 to 999,999,999.9999
139	Lower limit 1 for judgment	Set/Get	-999,999,999.9999 to 999,999,999.9999
140	Upper limit 2 for judgment	Set/Get	-999,999,999.9999 to 999,999,999.9999
141	Lower limit 2 for judgment	Set/Get	-999,999,999.9999 to 999,999,999.9999
142	Upper limit 3 for judgment	Set/Get	-999,999,999.9999 to 999,999,999.9999
143	Lower limit 3 for judgment	Set/Get	-999,999,999.9999 to 999,999,999.9999
144	Upper limit 4 for judgment	Set/Get	-999,999,999.9999 to 999,999,999.9999
145	Lower limit 4 for judgment	Set/Get	-999,999,999.9999 to 999,999,999.9999
146	Upper limit 5 for judgment	Set/Get	-999,999,999.9999 to 999,999,999.9999
147	Lower limit 5 for judgment	Set/Get	-999,999,999.9999 to 999,999,999.9999
148	Upper limit 6 for judgment	Set/Get	-999,999,999.9999 to 999,999,999.9999
149	Lower limit 6 for judgment	Set/Get	-999,999,999.9999 to 999,999,999.9999
150	Upper limit 7 for judgment	Set/Get	-999,999,999.9999 to 999,999,999.9999
151	Lower limit 7 for judgment	Set/Get	-999,999,999.9999 to 999,999,999.9999
152	Upper limit 8 for judgment	Set/Get	-999,999,999.9999 to 999,999,999.9999
153	Lower limit 8 for judgment	Set/Get	-999,999,999.9999 to 999,999,999.9999
154	Upper limit 9 for judgment	Set/Get	-999,999,999.9999 to 999,999,999.9999
155	Lower limit 9 for judgment	Set/Get	-999,999,999.9999 to 999,999,999.9999
156	Upper limit 10 for judgment	Set/Get	-999,999,999.9999 to 999,999,999.9999
157	Lower limit 10 for judgment	Set/Get	-999,999,999.9999 to 999,999,999.9999
158	Upper limit 11 for judgment	Set/Get	-999,999,999.9999 to 999,999,999.9999
159	Lower limit 11 for judgment	Set/Get	-999,999,999.9999 to 999,999,999.9999
160	Upper limit 12 for judgment	Set/Get	-999,999,999.9999 to 999,999,999.9999
161	Lower limit 12 for judgment	Set/Get	-999,999,999.9999 to 999,999,999.9999
162	Upper limit 13 for judgment	Set/Get	-999,999,999.9999 to 999,999,999.9999
163	Lower limit 13 for judgment	Set/Get	-999,999,999.9999 to 999,999,999.9999
164	Upper limit 14 for judgment	Set/Get	-999,999,999.9999 to 999,999,999.9999
165	Lower limit 14 for judgment	Set/Get	-999,999,999.9999 to 999,999,999.9999
166	Upper limit 15 for judgment	Set/Get	-999,999,999.9999 to 999,999,999.9999
167	Lower limit 15 for judgment	Set/Get	-999,999,999.9999 to 999,999,999.9999

2-6-10 Command Formats

You can input commands to control the Sensor from an external device using the DI0 to DI7 signals.

Input Format

Commands are input in the following formats.

●FH series Sensor Controller

• One Line

Input format (DI7 to DI0)

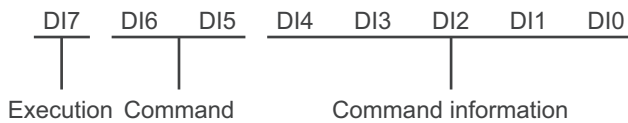

Set 0 (OFF) or 1 (ON) for each DI signal.

Confirm commands and command information, and turn DI7 (execution) ON with an interval of at least 1 [ms].

• Multi-line Random-trigger Mode

Two Lines

Input format (DI7 to DI0 and DILINE0)

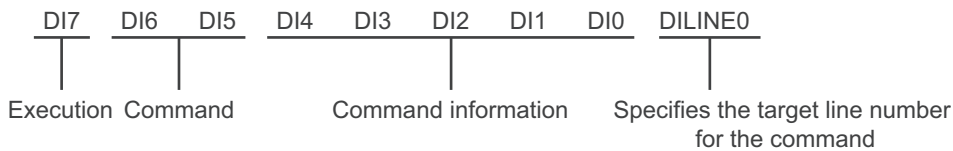

Three or Four Lines

Input format (DI7 to DI0, DILINE1, and DILINE0)

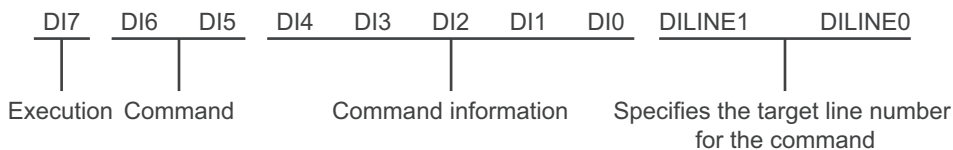

Five to Eight Lines

Input format (DI7 to DI0 and DILINE2 to DILINE0)

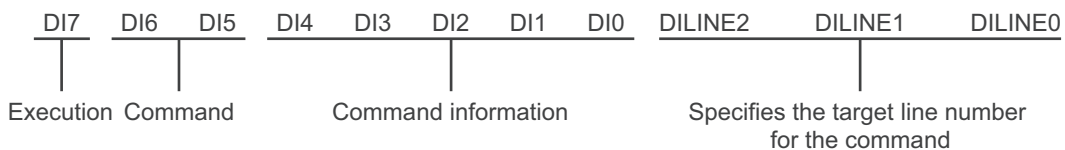

●FHV series (when not using the Smart Camera Data Unit (Parallel Interface) FHV-SDU10)

Input format (DI2 to DI0)

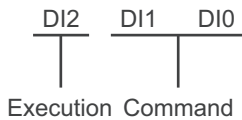

Set 0 (OFF) or 1 (ON) for each DI signal.

Confirm commands and command information, and turn DI2 (execution) ON with an interval of at least 1 [ms].

● FHV series (when using the Smart Camera Data Unit (Parallel Interface) FHV-SDU10)

Input format (DI7 to DI0)

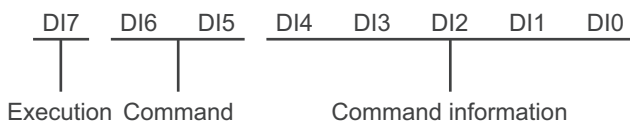

Set 0 (OFF) or 1 (ON) for each DI signal.

Confirm commands and command information, and turn DI7 (execution) ON with an interval of at least 1 [ms].



Precautions for Correct Use

In FHV series, commands equivalent to those of the FH series is available when the Smart Camera data unit interface is connected.

Command Lists

The commands and command formats are described in the following tables.

● One Line

• FH series Sensor Controller

Data	Description	Input format (DI7 to DI0)			Input example
		Execute (DI7)	Command (DI6, DI5)	Command information (DI4 to DI0)	
Continuous Measurement	Performs measurement continuously while command is being input.	1	00	The Sensor Controller does not check this signal, so a setting of either 0 or 1 makes no difference.	10000000
Switch Scene	Switches the measurement scene.	1	01	Input [Scene No.] in binary format (0 to 31).	Switching to Scene 2: 10100010
Switch Scene Group	Switches the measurement scene groups.	1	11	Input [Scene Group No.] in binary format (0 to 31).	Switching to Scene Group 2: 11100010
Clear Measurement Values	Clears measurement values. The OR signal and DO signal are not cleared.	1	10	00000	11000000

Data	Description	Input format (DI7 to DI0)			Input example
		Execute (DI7)	Command (DI6, DI5)	Command information (DI4 to DI0)	
Clear Error	Clears the error output. The ERROR indicator is also cleared.	1	10	00001	11000001
Clear Parallel OR +DO	Clears the OR signal and DO signal.	1	10	00010	11000010
Clear Wait State	Clears the wait state of the parallel flow control processing item.	1	10	01111	11001111

0: OFF 1: ON

- **FHV series (when not using the Smart Camera Data Unit (Parallel Interface) FHV-SDU10)**

Data	Description	Input format (DI2 to DI0)		Input example
		Execute (DI2)	Command (DI1, DI0)	
Clear Measurement Values, Error, OR	Clears the measurement values, OR signal, and Error signal. The ERROR indicator is also cleared.	1	10	110

0: OFF 1: ON

- **FHV series (when using the Smart Camera Data Unit (Parallel Interface) FHV-SDU10)**
Refer to **One Line - FH series Sensor Controller**.

- **Multi-line Random-trigger Mode**

- **FH series Sensor Controller**

Data	Description	Input format (DI7 to DI0, DILINE0, DILINE1, and DILINE2)				Input example (DILINE2 to DILINE0, DI7 to DI5, and DI4 to DI0)
		Execute (DI7)	Command (DI6, DI5)	Command information (DI4 to DI0)	Line number *1	
Continuous Measurement	Performs measurement continuously while command is being input.	1	00	***** The Sensor Controller does not check this signal, so a setting of either 0 or 1 makes no difference.	Specify the line number to send a command to. <ul style="list-style-type: none"> Two lines: 0 or 1 Three or four lines: 00 (line 0) 01 (line 1) 10 (line 2) 11 (line 3) Five to eight lines: 000 (line 0) 001 (line 1) 010 (line 2) 011 (line 3) 100 (line 4) 101 (line 5) 110 (line 6) 111 (line 7) 	Continuous measurement on line 1 when 2 lines are used: 0 100 00000
Switch Scene	Switches the measurement scene.	1	01	Input [Scene No.] in binary format (0 to 31).		Switching to scene 2 on line 2 when 4 lines are used: 10 101 00010
Switch Scene Group	Switches the measurement scene groups.	1	11	Input [Scene Group No.] in binary format (0 to 31).		Switching to scene group 3 on line 6 when 8 lines are used: 110 111 00011
Clear Measurement Values	Clears measurement values. The OR signal and DO signal are not cleared.	1	10	00000		Clearing the measurement results for line 1 when 2 lines are used: 1 110 00000
Clear Error	Clears the error output. The ERROR indicator is also cleared.	1	10	00001		Clearing the error status for line 1 when 4 lines are used: 01 110 00001
Clear Parallel OR +DO	Clears the OR signal and DO signal. *2	1	10	00010		Clearing the OR and Do signals for line 2 when 8 lines are used: 010 110 00010

Data	Description	Input format (DI7 to DI0, DILINE0, DILINE1, and DILINE2)				Input example (DILINE2 to DILINE0, DI7 to DI5, and DI4 to DI0)
		Execute (DI7)	Command (DI6, DI5)	Command information (DI4 to DI0)	Line number *1	
Clear Wait State	Clears the wait state of the parallel flow control processing item.	1	10	01111		11001111

*1. Two lines: DILINE0

Three or four lines: DILINE0 and DILINE1

Five to eight lines: DILINE0 to DILINE2

*2. Only the signals assigned to the line to which a command was sent can be cleared. The OR and DO signals are not cleared for other lines. If the command is sent to a line that cannot use the DO signals, only the OR signal will be cleared.

2-6-11 Time Charts

The ON/OFF timing of related signals during data output after the completion of measurement and during the sequence of operation from input of the control command until data output after the completion of measurement is indicated below in a timing chart.

Timing chart at startup

This section describes the timing chart at startup.



Precautions for Correct Use

- For details of functions and operation of each signal, refer to 2-6-8 *I/O Signals* on page 2-385.
- Input the STEP signals and DI0 to DI7 signals after the RUN signal turns ON.

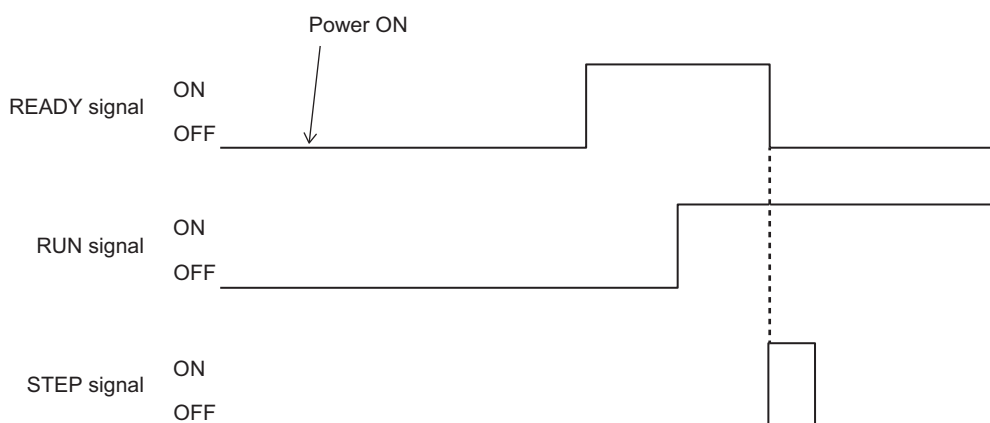

- (1) Turn ON power.
- (2) The READY signal turns ON when the trigger signal becomes acceptable.
- (3) The STEP signal is input after checking the RUN signal is ON.

Output Control Timing Charts

This section provides timing charts for each output control type (none, handshaking, and synchronization output).

In the FHV series, there is no DO 0 to DO 15, GATE signal.



Precautions for Correct Use

- For details of functions and operation of each signal, refer to 2-6-8 *I/O Signals* on page 2-385.

● Output Control: None

Example: Three Data Items Set for Parallel Data Output
Time Chart

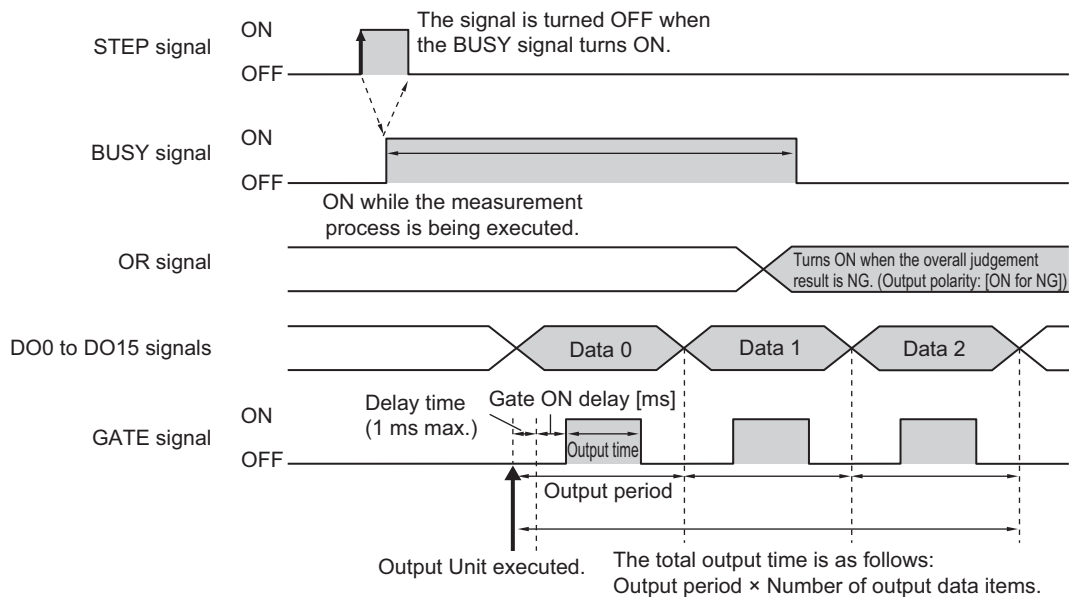

- (1) Turn ON the STEP signal while the BUSY signal is OFF.
- (2) Measurement begins and the BUSY signal is turned ON during the measurement process.
- (3) Measurement data is output when a Parallel Data Output Unit in the measurement flow is executed.
- (4) After the data output processing, the GATE signal is turned ON after the time set for the **Gate ON delay** in the parallel communications settings has elapsed.
A delay of up to 1 [ms] will occur when the GATE signal is turned ON. (This applied only to the FH series Sensor Controller.)
Set the GATE ON delay and output time for the GATE signal so that the total time does not exceed the output period.
- (5) After the GATE signal is turned ON, the GATE signal is turned OFF after the time set for the **Output time** in the parallel communications settings has elapsed.
Set the GATE ON delay and output time for the GATE signal so that the total time does not exceed the output period.
- (6) If the output processing for the next data item is completed, the next GATE signal will be turned ON after the time set for the **Output period** has elapsed from the end of processing in step 5 above.
- (7) After measurement is completed, the OR signal is output based on the measurement results and the BUSY signal is turned OFF.



Precautions for Correct Use

Data Output Time and STEP Signal Input Interval

Set the input interval for the STEP signal so that it is longer than the total output time. If the STEP signal input interval were shorter than the total output time, the data output buffer will eventually overflow and data will be lost.



Additional Information

When the parallel judgment output unit is performed, the GATE signal turns ON once.

● Output Control: Handshaking

Example: Three Data Items Set for Parallel Data Output

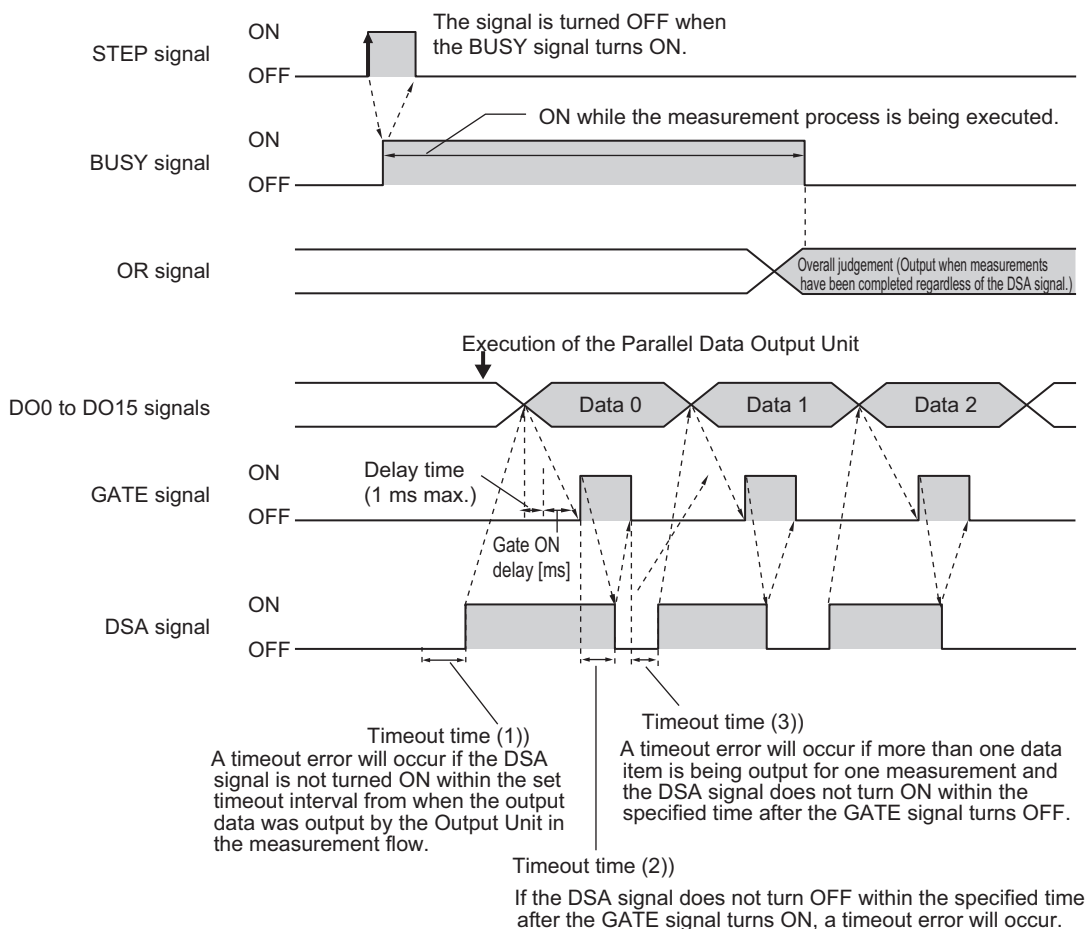

- (1) Turn ON the STEP signal while the BUSY signal is OFF.
- (2) Measurement begins and the BUSY signal is turned ON during the measurement process.
- (3) Turn ON the DSA signal from the external device to request data transmission after the STEP signal turns ON.
A timeout error will occur if the DSA signal were not turned ON within the set timeout interval from when the output data was output by the Output Unit in the measurement flow. (1)
- (4) After measurement is completed, the OR signal is output based on the measurement results and the BUSY signal is turned OFF.
- (5) Measurement data is output when a Parallel Data Output Unit in the measurement flow is executed.
- (6) The GATE signal is turned ON if the DSA signal is ON after data output processing.
A delay of up to 1 [ms] will occur when the GATE signal is turned ON. (This applied only to the FH series Sensor Controller.)
- (7) The user (PLC) reads the data and turns OFF the DSA signal when the GATE signal turns ON.
A timeout error will occur, if the DSA signal were not turned OFF within the specified time after the GATE signal turned ON. (2)
- (8) The GATE signal turns OFF if the DSA signal is turned OFF.
A timeout error will occur, if the DSA signal were not turned OFF within the specified time after the GATE signal turned ON. (2)
- (9) A timeout error will occur, if more than one data item is being output for one measurement and you do not turn ON the DSA signal within the specified timeout time after the GATE signal turns OFF. (3)



Additional Information

When the parallel judgment output unit is performed, the GATE signal turns ON once if the DSA signal is ON.

● Output Control: Synchronization Control

Operation When **Number of Delays** Is Set to 2:

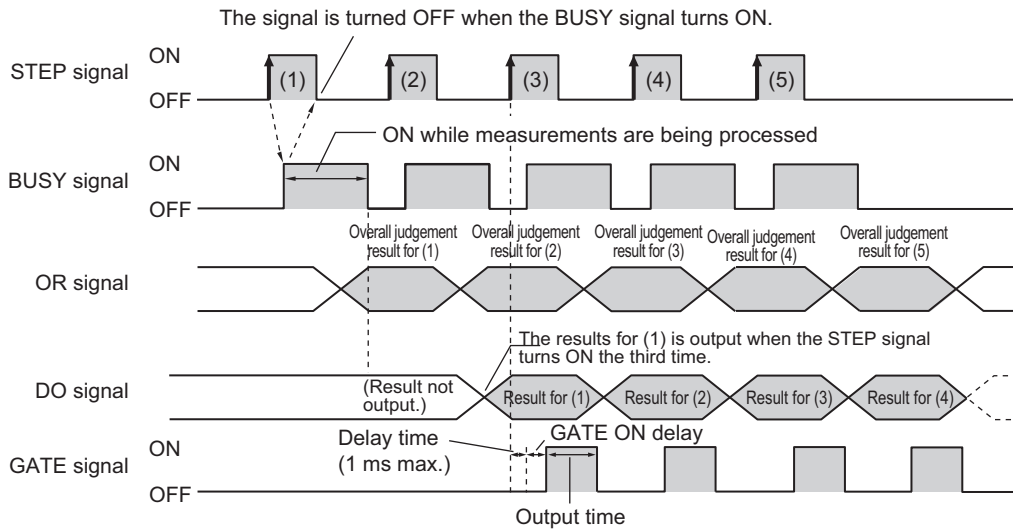

- (1) Turn ON the STEP signal while the BUSY signal is OFF.
- (2) After measurement is completed, the OR signal is output based on the measurement results and the BUSY signal is turned OFF.
- (3) When the STEP signal turns ON for the third time, the measurement results (DO) for the first time that the STEP signal turned ON are output and the GATE signal is turned ON after the time set for the **GATE ON delay** has elapsed.
- (4) When the STEP signal turns ON for the fourth time, the measurement results (DO) for the second time that the STEP signal turned ON are output and the GATE signal is turned ON after the time set for the **GATE ON delay** has elapsed.
A delay of up to 1 [ms] will occur when the GATE signal is turned ON. (This applied only to the FH series Sensor Controller.)
- (5) Each time the STEP signal turns ON after that, the measurement result (DO) from when the STEP signal turned ON two times previously is output.

Command Timing Charts



Precautions for Correct Use

- For details of functions and operation of each signal, refer to *2-6-8 I/O Signals* on page 2-385.

● Continuous Measurement

Measurement is performed continuously while the DI7 signal is ON.
Continuous measurement is stopped when the DI7 signal is turned OFF.

When an Expression Is Set in **Parallel Data Output** with No Output Control:

• Time Chart

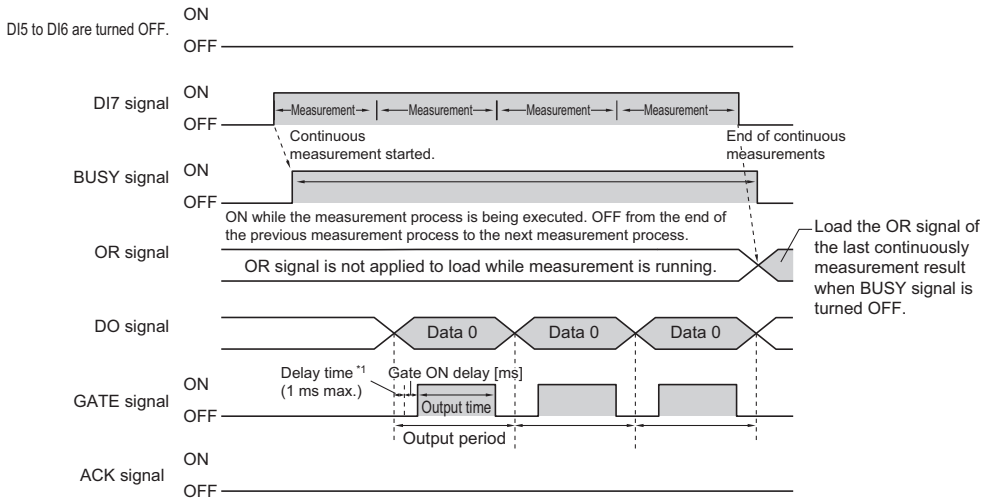

^{**1} A delay of up to 1 ms will occur when the GATE signal is turned ON. (This applied only to the FH series Sensor Controller.)

• Input Signals

Signal	Description
DI5 to DI6	These signals are turned OFF during continuous measurement. (i.e., while DI7 is ON.)
DI7	This is the execution trigger. After DI0 to DI6 are set, turn ON DI7 after an interval over 1 [ms]. Always keep this signal turned ON during continuous measurement. Continuous measurement is stopped when this signal is turned OFF.



Precautions for Correct Use

- The measurement during continuous measurement is given priority. Therefore, display of the measurement results (overall judgment, images, judgment for each processing unit in the flow display, and detailed results) may sometimes not be updated.
 - Load the OR signal of the last continuously measurement result when BUSY signal is turned OFF.
 - When continuous measurement are ended, the measurement results from the last measurement will be displayed.
 - The next internal trigger is executed after the measurement is completed, but the time until the next measurement execution is not constant. If you want to perform measurement at regular intervals, use STEP signals instead of continuous measurement.
 - OR signal is not applied to load while measurement is running. When you want to get the Overall judgment result during measurement, assign *TJG* to the *Parallel Data Output* or *Parallel Judgment Output*. For details, refer to *1-3-1 Basic Control Operations of the Sensor Controller* on page 1-4.
 - After the continuous measurement was completed, read the OR signal for the last measurement results at the time when the BUSY signal switched from ON to OFF.
-



Additional Information

- When the input command is not received correctly, the ERROR signal turns ON.
 - Acquisition is difficult because the amount of time during which the BUSY signal is OFF during continuous measurement for a parallel command may be extremely short.
-

● **Scene/Scene Group Switch**

Scenes and scene groups are switched as follows.

After the number of the desired scene or scene group is set in DI0 to DI6, turning ON DI7 switches the scene or scene group to the number set.

• **Time Charts**

FH series Sensor Controller

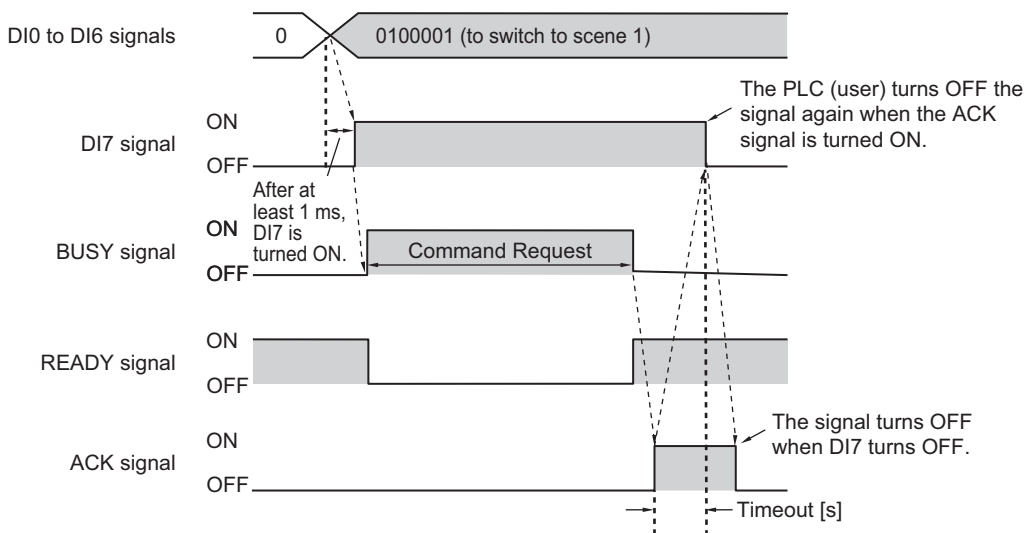

• **Output Signals**

Signal	Description
BUSY	Indicates that the Sensor Controller is currently switching the scene or scene group. Do not input next command while the BUSY signal is ON. Otherwise, on-going processing or commands that are input will not be performed correctly.
READY	Turns OFF while a scene or a scene group is being switched. Turns OFF as long as the BUSY signal is ON.
ACK	Turns ON when execution of the DI command is completed.



Additional Information

When the input command is not received correctly, the ERROR signal turns ON.



Precautions for Correct Use

Do not switch the scene group during parallel continuous measurement or when the STEP signal is being input continuously. If you must switch the scene group at one of these times, set *Unchecked* in *Save scene group on scene switch* in either of the settings items below.

- Refer to *Changing the Scene or Scene Group* in the *Vision System FH/FHV Series User's Manual (Cat. No.Z365)*.
- Refer to *Setting the Conditions That Are Related to Operation during Measurement* in the *Vision System FH/FHV Series User's Manual (Cat. No.Z365)*.

• **Input Signals (Scene/Scene Group Switching)**

Signal	Description
DI0 to DI4	Sets the scene number (0 to 31). When a DI terminal offset is set, the set offset is added.
DI5	ON
DI6	Scene switching: OFF Scene Group switching: ON
DI7	This is the execution trigger. After DI0 to DI6 are set, turn ON DI7 after an interval over 1 [ms]. After checking that the ACK signal has turned ON, turn DI7 OFF and then turn DI0 to DI6 OFF. Refer to <i>Setting the Conditions That Are Related to Operation during Measurement</i> in the <i>Vision System FH/FHV Series User's Manual (Cat. No. Z365)</i> .



Additional Information

The amount of time during which the BUSY signal is turned ON when a scene is switched can be changed.

Select **Measurement setting**] from the **Measure** menu and make the setting in the conditions related to operation during measurement.

Refer to *Setting the Conditions That Are Related to Operation during Measurement* in the *Vision System FH/FHV Series User's Manual (Cat. No.Z365)*.

● **Clear Measurement Values**

The measurement result is cleared as follows.

• **Time Charts**

FH series Sensor Controller

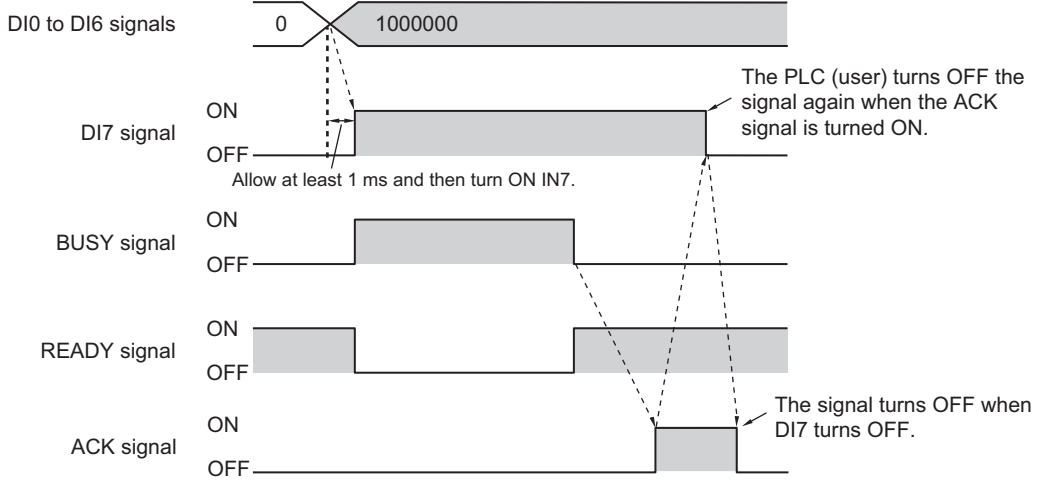

• **Output Signals**

Signal	Description
BUSY	Turns ON when the measurement value is being cleared. The amount of time during which the BUSY signal is turned ON is approximately 1 [ms].
READY	Turns OFF when the command to clear the measurement value is being executed.
ACK	Turns ON when execution of the DI command is completed.

• **Input Signals**

Signal	Description
DI0 to DI4	Turns OFF.
DI5	Turns OFF.
DI6	Turns ON.
DI7	This is the trigger signal to clear a measurement value. After DI0 to DI6 are set, turn ON DI7 after an interval over 1 [ms].

● **Clear Parallel OR+DO**

The OR signal and DO signals are cleared as follows.

• **Time Chart**

FH series Sensor Controller

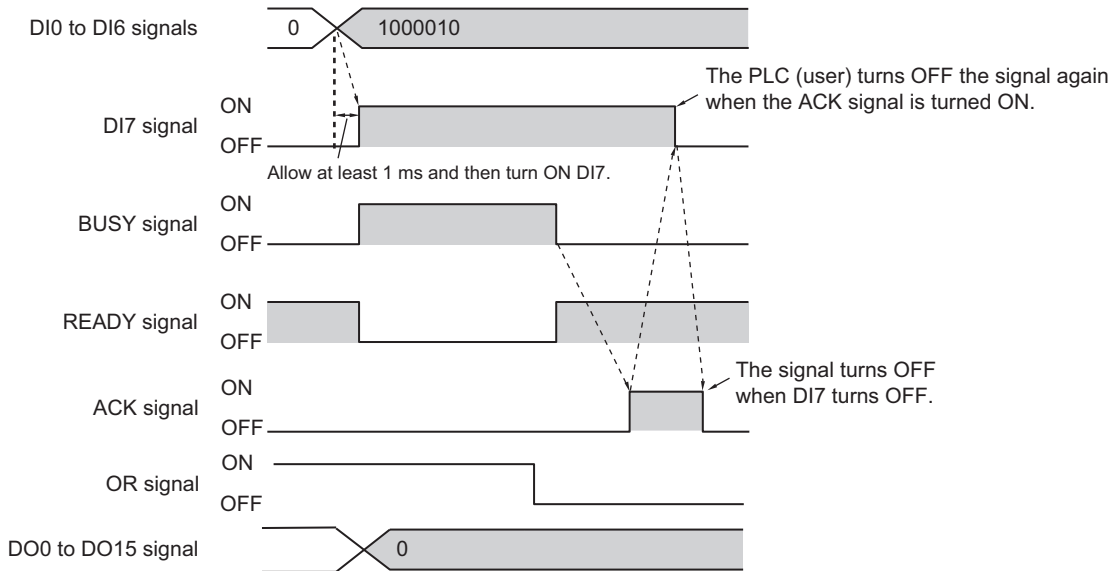

• **Output Signals**

Signal	Description
BUSY	Turns ON while the OR and DO signals are cleared. The amount of time during which the BUSY signal is turned ON is approximately 1 [ms].
READY	Turns OFF while the command to clear the OR and DO signals is executed.
ACK	Turns ON when execution of the DI command was completed.
OR	It will turn OFF if it was turned ON.
DO0 to DO15	It will turn OFF if it was turned ON.

• **Input Signals**

Signal	Description
DI0	Turns OFF.
DI1	Turns ON.
DI2 to DI4	Turns OFF.
DI5	Turns OFF.
DI6	Turns ON.
DI7	This is the trigger signal to clear the OR and DO signal. After DI0 to DI6 are set, turn ON DI7 after an interval over 1 [ms]. After checking that the ACK signal has turned ON, turns DI7 OFF and then turn DI0 to DI6 OFF.

● **Clear Error**

The error signal is cleared as follows.

• **Time Chart**

FH series Sensor Controller

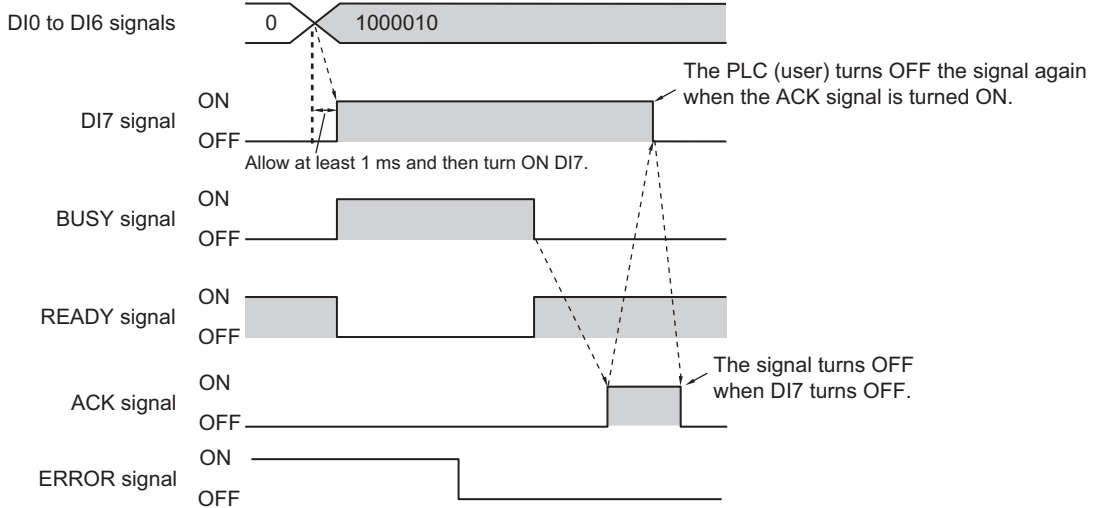

• **Output Signals**

Signal	Description
BUSY	Turns ON while the ERROR signal is cleared. The amount of time during which the BUSY signal is turned ON is approximately 1 [ms].
READY	Turns OFF while the command to clear the ERROR signal is executed.
ACK	Turns ON when execution of the DI command was completed.
ERROR	After the error is removed, the signal turns OFF when the FH series Sensor Controller executes the error clear processing.

• **Input Signals**

Signal	Description
DI0	Turns ON.
DI1 to DI4	Turns OFF.
DI5	Turns OFF.
DI6	Turns ON.
DI7	This is the trigger signal to clear an error. After DI0 to DI6 are set, turn ON DI7 after an interval over 1 [ms]. After checking that the ACK signal has turned ON, turns DI7 OFF and then turn DI0 to DI6 OFF.

● **Clear Measurement Values, Error, OR**

Clears the Measurement Values, OR signal and Error signal.

The ERROR indicator is also cleared.

• **Time Chart**

FHV series (when not using the Smart Camera Data Unit (Parallel Interface) FHV-SDU10):

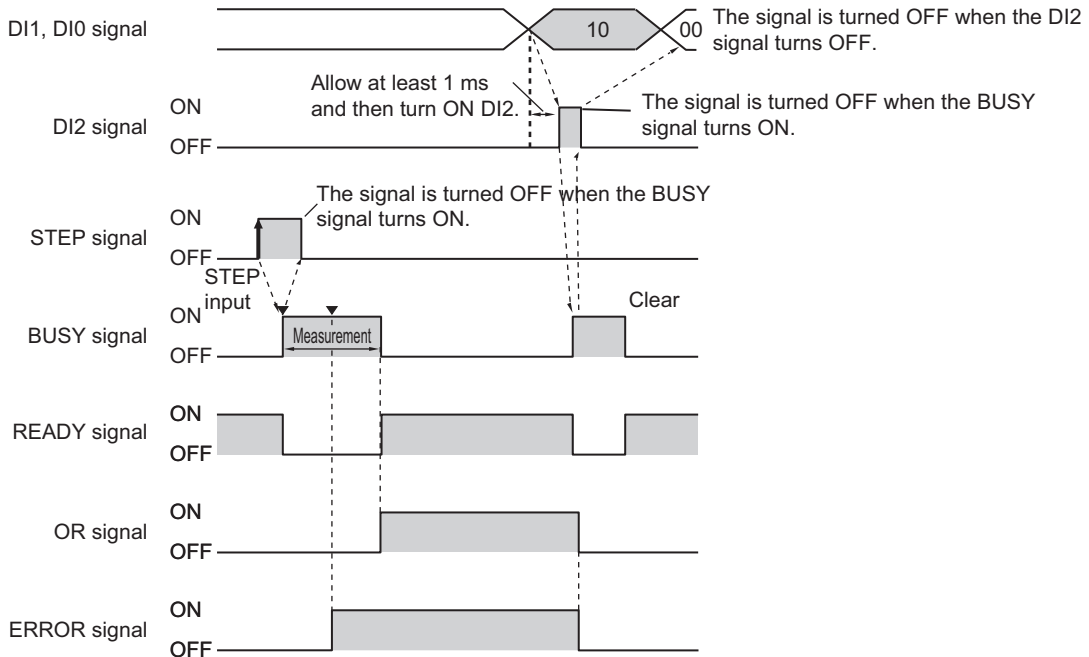

FHV series (when using the Smart Camera Data Unit (Parallel Interface) FHV-SDU10):

Refer to *Clear Measurement Values* on page 2-411, *Clear Parallel OR+DO* on page 2-412, *Clear Error* on page 2-413 when using the Data Unit for the Smart Camera (Parallel Interface) FHV-SDU10.

• **Output Signals**

Signal	Description
BUSY	The BUSY signal is ON during the command execution. The amount of time during which the BUSY signal is turned ON is approximately 1 [ms].
READY	The READY signal is OFF during the command execution.
OR	It will turn OFF if it was turned ON.
ERROR	After the error is removed, the signal turns OFF when the FHV series executes the error clear processing.

• **Input Signals**

Signal	Description
D10	Turns OFF.
D11	Turns ON.

Signal	Description
DI2	<p>This is the trigger signal to clear Measurement Values, Error, OR signals.</p> <p>After DI0 and DI1 are set, turn ON DI2 after an interval over 1 [ms].</p> <p>The BUSY signal is ON during command execution. After checking that the BUSY signal has turned ON, turn DI2 OFF, and then turn DI0, DI1 OFF.</p> <p>Note, however, that the amount of time during which the BUSY signal is turned ON is approximately 1 [ms]. If it cannot be recognized whether the BUSY signal is turned ON or not by an external device, control the timing so that the DI2 signal is turned ON for approximately 5 [ms].</p>

2-6-12 Parallel Troubleshooting

Problem	Cause	Action
Data is not output at all.	You have selected more than three lines in Multi-line Random-trigger Mode.	Decrease the number of lines or use a communications method other than parallel communications.
	The <i>Output</i> setting is turned OFF.	Select Layout setup in the Window menu on the Main Window, and then turn ON the <i>Output</i> setting.
Even though there is more than one data output item, only the last data item is output.	The data is being overwritten because the ON status of the GATE signal is not being checked.	Read data only when the GATE signal is ON. Use handshaking for the output control to control the output timing.
STGOUT and SHTOUT are not being output.	You have selected a different signal in the system settings.	Select the correct signal for the application in the <i>Output signal selection</i> of the output signal settings in the system settings.
Measurement is not executed even when a STEP signal is input.	The STEP signal is chattering.	Check the contacts and input method used to prevent chattering. Set the STEP signal filter to a period longer than the input period that results in chattering.
The STEP signal is input at random.	Unintended STEP signals are being input due to noise.	Perform noise prevention measures. Set the STEP signal filter to a period longer than the input period that results in chattering.
The READY signal remains OFF.	The image mode is set to <i>Through Mode</i> on the Main Window.	Change the image mode to <i>Freeze</i> or <i>Last NG</i> .
	Camera Image Input HDR or Camera Image Input HDR Lite is being used in the current measurement flow.	When using Camera Image Input HDR or Camera Image Input HDR Lite , the READY signal will turn OFF for the number of Camera images taken.
	More than one Camera Image Input is being used in the current measurement flow.	If you execute more than one Camera Image Input in a single measurement flow, the Ready signal will turn OFF for the number of Camera images taken.
There is a delay in the SHTOUT ON timing.	You are using more than one Camera in the current measurement flow.	When you use more than one Camera, the SHTOUT signal turns ON only after the slowest Camera exposure is completed.



Appendices

A

A-1	Command Control	A-2
A-1-1	Parameter Notation Examples for Command Control	A-2
A-1-2	Details of Commands Used in EtherCAT Communications	A-6
A-1-3	Command List.....	A-7
A-1-4	Command Details for PLC Link, EtherNet/IP, EtherCAT, and PROFINET	A-16
A-1-5	Non-procedure Command Details	A-81

A-1 Command Control

This section describes the commands that are used to control the Sensor Controller from an external device.

A-1-1 Parameter Notation Examples for Command Control

This section provides examples of binary inputs of parameters such as arguments for command control.



Additional Information

The command code is the same, but the order in which the command parameters are stored depends on the manufacturer of the connected PLC as follows:

- OMRON and Yaskawa Electric PLCs: Upper byte followed by lower byte
- Mitsubishi Electric PLCs: Lower byte followed by upper byte^{*1}

*1: The order of displayed sequence program may be from upper byte to low byte. If it does not perform correctly, confirm the order of upper and low byte.

● Four-byte Data

The following example shows the input to switch the scene to scene number 5 with the Switch Scene command.

First word in Command Area	Description
+2 and +3 words	Command code
+4 and +5 words	Scene number (Command parameters)

- **OMRON or Yaskawa Electric PLCs**
Command (PLC to Sensor Controller)

First word in Command Area	Hexadecimal notation	Bit				Description
		15 - 12	11 - 8	7 - 4	3 - 0	
+2	1000	0001	0000	0000	0000	Command code
+3	0030	0000	0000	0011	0000	
+4	0005	0000	0000	0000	0101	Scene number (Command parameters)
+5	0000	0000	0000	0000	0000	

- **Mitsubishi Electric PLCs**
Command (PLC to Sensor Controller)

First word in Command Area	Hexadecimal notation	Bit				Description
		15 - 12	11 - 8	7 - 4	3 - 0	
+2	1000	0001	0000	0000	0000	Command code
+3	0030	0000	0000	0011	0000	

First word in Command Area	Hexadecimal notation	Bit				Description
		15 - 12	11 - 8	7 - 4	3 - 0	
+4	0500	0000	0101	0000	0000	Scene number (Command parameters)
+5	0000	0000	0000	0000	0000	

● **Specifying Character Strings**

Specify the ASCII character code for every two bytes.

In this example, the inputs are given to save the image data for image data 1 to a destination specified by the absolute path (\E:\IMG01\LABEL.IFZ) with the Save Image command.

First word in Command Area	Description
+2 and +3 words	Command code
+4 and +5 words	Image data number: 1 (Command parameters)
+6 to +15 words	Save destination: (\E:\IMG01\LABEL.IFZ) (Command parameters)

• **OMRON or Yaskawa Electric PLCs**

Command (PLC to Sensor Controller)

First word in Command Area	Hexadecimal notation	Bit				Description
		15 - 12	11 - 8	7 - 4	3 - 0	
+2	4000	0100	0000	0000	0000	Command code
+3	0070	0000	0000	0111	0000	
+4	0001	0000	0000	0000	0001	Image data number
+5	0000	0000	0000	0000	0000	
+6	5c45	0101	1100	0100	0101	Save destination +6:5c45 (\E) +7:3a5c (:\ +8:494d (IM) +9:4730 (G0) +10:315c (1\ +11:4c41 (LA) +12:4245 (BE) +13:4c2e (L.) +14:4946 (IF) +15:5a00 (Z) +16:0000 (NULL) +17:0000 (NULL) +18:0000 (NULL)
+7	3a5c	0011	1010	0101	1100	
+8	494d	0100	1001	0100	1101	
+9	4730	0100	0111	0011	0000	
+10	315c	0011	0001	0101	1100	
+11	4c41	0100	1100	0100	0001	
+12	4245	0100	0010	0100	0101	
+13	4c2e	0100	1100	0010	1110	
+14	4946	0100	1001	0100	0110	
+15	5a00	0101	1010	0000	0000	
+16	0000	0000	0000	0000	0000	
+17	0000	0000	0000	0000	0000	
+18	0000	0000	0000	0000	0000	

• **Mitsubishi Electric PLCs**

Command (PLC to Sensor Controller)

First word in Command Area	Hexa-decimal notation	Bit				Description
		15 - 12	11 - 8	7 - 4	3 - 0	
+2	4000	0100	0000	0000	0000	Command code
+3	0070	0000	0000	0111	0000	
+4	0001	0000	0000	0000	0001	Image data number
+5	0000	0000	0000	0000	0000	
+6	455c	0100	0101	0101	1100	Save destination
+7	5c3a	0101	1100	0011	1010	+6:455c (E\)
+8	4d49	0100	1101	0100	1001	+7:5c3a (\:)
+9	3047	0011	0000	0100	0111	+8:4d49 (MI)
+10	5c31	0101	1100	0011	0001	+9:3047 (0G)
+11	414c	0100	0001	0100	1100	+10:5c31 (\1)
+12	4542	0100	0101	0100	0010	+11:414c (AL)
+13	2e4c	0010	1110	0100	1100	+12:4542 (EB)
+14	4649	0100	0110	0100	1001	+13:2e4c (.L)
+15	005a	0000	0000	0101	1010	+14:4649 (FI)
+16	0000	0000	0000	0000	0000	+15:005a (Z)
+17	0000	0000	0000	0000	0000	+16:0000 (NULL)
+18	0000	0000	0000	0000	0000	+17:0000 (NULL)
						+18:0000 (NULL)

● **Specifying Real Numbers**

Specify the actual value multiplied by 1,000 to specify a real number.

In this example, the inputs are given to set the lower limit value (external reference number 137) of measurement coordinate X to 123.4 for the *Search* processing item that is registered to processing unit 1 by the Set Unit Data command.

First word in Command Area	Description
+2 and +3 words	Command code
+4 and +5 words	Unit number: 1 (Command parameters)
+6 and +7 words	External reference number: 137 (Command parameters)
+8 and +9 words	Lower limit of measurement coordinate X: 123.4 (x 1,000 = 123,400) (Command parameters)

• **OMRON or Yaskawa Electric PLCs**

Command (PLC to Sensor Controller)

First word in Command Area	Hexa-decimal notation	Bit				Description
		15 - 12	11 - 8	7 - 4	3 - 0	
+2	1000	0001	0000	0000	0000	Command code
+3	0050	0000	0000	0101	0000	
+4	0001	0000	0000	0000	0001	Unit number
+5	0000	0000	0000	0000	0000	
+6	0089	0000	0000	1000	1001	External reference number
+7	0000	0000	0000	0000	0000	

First word in Command Area	Hexadecimal notation	Bit				Description
		15 - 12	11 - 8	7 - 4	3 - 0	
+8	e208	1100	0010	0000	1000	Lower limit of measurement coordinate X
+9	0001	0000	0000	0000	0001	

• **Mitsubishi Electric PLCs**

Command (PLC to Sensor Controller)

First word in Command Area	Hexadecimal notation	Bit				Description
		15 - 12	11 - 8	7 - 4	3 - 0	
+2	1000	0001	0000	0000	0000	Command code
+3	0050	0000	0000	0101	0000	
+4	0100	0000	0001	0000	0000	Unit number
+5	0000	0000	0000	0000	0000	
+6	8900	1000	1001	0000	0000	External reference number
+7	0000	0000	0000	0000	0000	
+8	08e2	0000	1000	1110	0010	Lower limit of measurement coordinate X
+9	0100	0000	0001	0000	0000	

A-1-2 Details of Commands Used in EtherCAT Communications

Command codes and command parameters used in EtherCAT communications are specified as described below via the I/O port.

Command Code	:Holds the command code to execute.
Command Parameter 0 to 3	:Holds the parameter for the command to execute.



Precautions for Correct Use

Since Command Parameter 3 is the reserved area, it is unavailable. Use Command Parameter 0 to 2.

Command details written in the Appendix are described based on PLC memory addresses. When specifying command codes and command parameters in EtherCAT communications, replace the command details with the description in the table below.

First word in Command Area	Hexa-decimal notation	Bit				
		15-12	11-8	7-4	3-0	
+2	0000	0000	0000	0000	0000	} Command Code 4 bytes
+3	0000	0000	0000	0000	0000	
+4	0000	0000	0000	0000	0000	} Command Parameter 0 4 bytes
+5	0000	0000	0000	0000	0000	
+6	0000	0000	0000	0000	0000	} Command Parameter 1 4 bytes
+7	0000	0000	0000	0000	0000	
+8	0000	0000	0000	0000	0000	} Command Parameter 2 4 bytes
+9	0000	0000	0000	0000	0000	
+10	0000	0000	0000	0000	0000	} Command Parameter 3 4 bytes
+11	0000	0000	0000	0000	0000	

A-1-3 Command List

This section lists the commands that you can use with the FH / FHV series Sensor Controller and the communications protocols for which each command is supported.



Additional Information

In addition to the standard communication commands that are given here, you can also create custom commands and define the processing for them.

Creating custom commands is useful to expand the function of a standard command to create more advanced commands, and to otherwise combine multiple commands into one command to simplify controlling operation from a PLC or other external device.

Refer to *Custom Communications Commands* in the *Vision System FH/FHV Series User's Manual (Cat. No. Z365)*.



Precautions for Correct Use

- In the FHV series, parallel commands other than measurements, errors, and OR signal clear are available when the parallel I/O signal extension unit (FHV-SDU10) for the Smart Camera data unit is connected. If not connected, only measurements, errors, and OR signal clear can be used.
- In the FHV series, EtherCAT communication commands are available only when the EtherCAT interface communication unit (FHV-SDU30) for the Smart Camera data unit is connected.

● Execution Commands

OK: Applicable command, RST: Command with restricted execution, NA: Non-applicable command

Function	Parallel Ref.: page 2-399	PLC link Ref.: page 2-177	EtherNet/IP Ref.: page 2-240	EtherCAT Ref.: page 2-51	PROFINET Ref.: page 2-303	Non-procedure Ref.: page 2-349
Performs measurement one time.	NA*1	OK	OK*1	OK*1	OK*1	OK
Performs continuous measurement.	OK	OK	OK	OK	OK	OK
Ends continuous measurements.	NA	OK	OK	OK	OK	OK
Performs test measurement for the specified unit.	NA	OK	OK	OK	OK	OK
Clears all measurement result values.	OK	OK	OK	OK	OK	OK
Clears the data output buffer.	NA	NA	OK	OK	OK	NA
Clears the data output buffer and Output Area, and the value becomes 0.	NA	NA	NA	OK	NA	NA

Function	Parallel Ref.: page 2-399	PLC link Ref.: page 2-177	EtherNet/IP Ref.: page 2-240	EtherCAT Ref.: page 2-51	PROFINET Ref.: page 2-303	Non-procedure Ref.: page 2-349
Clears all measured values for the currently displayed scene. Clears the data output buffer and Output Area, and the value becomes 0 .	NA	NA	NA	OK	NA	NA
Saves the current system data and scene group data in the Sensor Controller.	NA	OK	OK	OK	OK	OK
Registers the model again.	NA	OK	OK	OK	OK	OK
Shifts the image display position by the specified amount.	NA	OK	OK	OK	OK	OK
Zooms the image display in or out by the specified factor.	NA	OK	OK	OK	OK	OK
Returns the display position and display magnification to their default values.	NA	OK	OK	OK	OK	OK
Copies the scene data.	NA	OK	OK	OK	OK	OK
Deletes the scene data.	NA	OK	OK	OK	OK	OK
Moves the scene data.	NA	OK	OK	OK	OK	OK
Registers the specified image data as a registered image.	NA	OK	RST* ²	NA	NA	OK
Loads the specified registered image as the measurement image.	NA	OK	OK	OK	OK	OK
Responds in the response areas +6+7 with the data that was set in command areas +4+5.	NA	OK	NA	NA	NA	NA
Returns an entered text string without changing it.	NA	NA	OK	OK	OK	OK
Executes the specified command string after a specified delay.	NA	NA	NA	NA	NA	OK
Adds a user account to a specified group ID.	NA	OK	RST* ²	NA	NA	OK
Deletes a specified user account.	NA	OK	RST* ²	NA	NA	OK
Branches to the start of the measurement flow (processing unit 0).	NA	OK	OK	OK	OK	OK

Function	Parallel Ref.: page 2-399	PLC link Ref.: page 2-177	EtherNet/IP Ref.: page 2-240	EtherCAT Ref.: page 2-51	PROFINET Ref.: page 2-303	Non-procedure Ref.: page 2-349
Restarts the Sensor Controller.	NA	OK	OK	OK	OK	OK
Clear Error	OK	NA	NA ^{*3}	NA ^{*3}	NA ^{*3}	NA
Clear Parallel OR+DO	OK	NA	NA	NA	NA	NA
Clear Measurement Values, Error, OR ^{*4}	OK	NA	NA	NA	NA	NA

- *1. You can execute the same operation with the Measurement Execution Bit (STEP signal is allocated for the parallel communications, EtherNet/IP, and PROFINET; Trigger bit is allocated for EtherCAT) in the control signals.
- *2. You cannot execute tag data link commands. Execute the command with message communications.
- *3. You can execute the same operation with the Error Clear Bit (EtherNet/IP and PROFINET: ERCLR, EtherCAT: Error Clear) in the control signals.
- *4. Clear Measurement Values, Error, OR is only possible in the FHV series.

● **Commands to Get Status**

OK: Applicable command, RST: Command with restricted execution, NA: Non-applicable command

Function	Parallel	PLC Link Ref.: page 2-178	EtherNet/IP Ref.: page 2-241	EtherCAT Ref.: page 2-52	PROFINET Ref.: page 2-303	Non-procedure Ref.: page 2-349
Gets the current scene number.	NA	OK	OK	OK	OK	OK
Gets the current scene group number.	NA	OK	OK	OK	OK	OK
Gets the number of the layout that is currently displayed.	NA	OK	OK	OK	OK	OK
Gets the number of the Unit that is currently displayed in the specified image display window.	NA	OK	OK	OK	OK	OK
Gets the sub-image number that is currently displayed in the specified image display window.	NA	OK	OK	OK	OK	OK
Gets the image mode for the specified image display window.	NA	OK	OK	OK	OK	OK
Gets the input status (prohibited/permitted) for the Communications Modules.	NA	OK	OK	OK	OK	OK
Gets the output status (prohibited/permitted) to an external device.	NA	OK	OK	OK	OK	OK
Gets the ON/OFF status for the specified parallel I/O terminal.	NA	OK	OK	OK	OK	OK
Gets the ON/OFF status of all parallel terminals except for DI terminals.	NA	OK	OK	OK	OK	OK
Gets the ON/OFF status of all parallel DI terminals.	NA	OK	OK	OK	OK	OK
Gets the user name for the user account currently logged in.	NA	OK	RST*1	NA	NA	OK
Gets the group ID for the account currently logged in.	NA	OK	RST*1	NA	NA	OK
Gets the current state of the operation log.	NA	OK	OK	OK	OK	OK

*1. You cannot execute tag data link commands. Execute the command with message communications.

● **Commands to Set Status**

OK: Applicable command, RST: Command with restricted execution, NA: Non-applicable command

Function	Parallel Ref.: page 2-399	PLC link Ref.: page 2-178	EtherNet/IP Ref.: page 2-241	EtherCAT Ref.: page 2-53	PROFINET Ref.: page 2-304	Non-procedure Ref.: page 2-350
Switches to the specified scene number.	OK	OK	OK	OK	OK	OK
Switches to the scene group with the specified number.	OK	OK	OK	OK	OK	OK
Sets the layout number and switches the image.	NA	OK	OK	OK	OK	OK
Sets the number of the Unit to display in the specified image display window.	NA	OK	OK	OK	OK	OK
Sets the number of the sub-image to display in the specified image display window.	NA	OK	OK	OK	OK	OK
Sets the image mode for the specified image display window.	NA	OK	OK	OK	OK	OK
Permits/prohibits inputs to the Communications Modules.	NA	OK	OK	OK	OK	OK
Permits/prohibits outputs to external devices.	NA	OK	OK	OK	OK	OK
Sets the ON/OFF status of the specified parallel I/O terminal.	NA	OK	OK	OK	OK	OK
Sets the ON/OFF status of all parallel terminals except for DO terminals.	NA	OK	OK	OK	OK	OK
Sets the ON/OFF status of all parallel DO terminals.	NA	OK	OK	OK	OK	OK
Switches the currently logged in account.	NA	OK	RST*1	NA	NA	OK
Sets the state of the operation log.	NA	OK	OK	OK	OK	OK

*1. You cannot execute tag data link commands. Execute the command with message communications.

● Commands to Read Data

OK: Applicable command, RST: Command with restricted execution, NA: Non-applicable command

Function	Parallel	PLC link Ref.: page 2-179	EtherNet/IP Ref.: page 2-242	EtherCAT Ref.: page 2-53	PROFINET Ref.: page 2-305	Non-pro- cedure Ref.: page 2-351
Gets the specified processing unit data.	NA	OK	OK	OK	OK	OK
Gets the value for a scene variable.	NA	NA	NA	NA	NA	OK
Gets the date and time.	NA	OK	RST ^{*1}	NA	NA	OK
Gets the Sensor Controller version information.	NA	OK	RST ^{*1}	NA	NA	OK
Gets settings related to image logging.	NA	OK	RST ^{*1}	NA	NA	OK
Gets the image logging folder name.	NA	OK	RST ^{*1}	NA	NA	OK
Gets the data logging folder name.	NA	OK	RST ^{*1}	NA	NA	OK
Gets the screen capture folder name.	NA	OK	RST ^{*1}	NA	NA	OK
Gets the prefix for the file name in which logged images are saved.	NA	OK	RST ^{*1}	NA	NA	OK
Gets the conditions set for data logging.	NA	OK	OK	OK	OK	OK
Gets the parallel DI terminal offset data that is set.	NA	OK	OK	OK	OK	OK

*1. You cannot execute tag data link commands. Execute the command with message communications.

● **Commands to Write Data**

OK: Applicable command, RST: Command with restricted execution, NA: Non-applicable command

Function	Parallel	PLC link Ref.: page 2-179	EtherNet/IP Ref.: page 2-242	EtherCAT Ref.: page 2-53	PROFINET Ref.: page 2-305	Non-pro- cedure Ref.: page 2-351
Sets the specified unit data.	NA	OK	OK	OK	OK	OK
Sets a value to a scene variable.	NA	NA	NA	NA	NA	OK
Sets the date and time.	NA	OK	RST*1	NA	NA	OK
Changes the settings related to image logging. *2	NA	OK	RST*1	NA	NA	OK
Sets the name for the image logging folder. *2	NA	OK	RST*1	NA	NA	OK
Sets the name for the screen capture folder.	NA	OK	RST*1	NA	NA	OK
Sets the name for the data logging folder. *2	NA	OK	RST*1	NA	NA	OK
Sets the prefix for the file name in which logged images are saved.	NA	OK	RST*1	NA	NA	OK
Sets the data logging conditions. *2	NA	OK	OK	OK	OK	OK
Sets the parallel DI terminal offset data.	NA	OK	OK	OK	OK	OK

*1. You cannot execute tag data link commands. Execute the command with message communications.

*2. When you save data, the save destination differs depending on Sensor Controller model.
The save destination differ depending on the Sensor Controller type.

When you use FH / FHV series, do not save to the any folder except RAMDisk and external storage device (such as C:\ProgramFiles\FZ). It is possible not to perform correctly due to the decrease of Scene data storage region.

Save destination	FH/FHV series
RAMDisk	C:\Data\RAMDisk
External storage	E:\, F:\, G:\, H:\, M:\, S:\, T:\, U:\, V:\, W:\, X:\, Y:\, Z:\

● File Load Commands

The load destination differs depending on the Sensor Controller model.

Load destination	FH/FHV series
RAMDisk	C:\Data\RAMDisk
External storage	E:\, F:\, G:\, H:\, M:\, S:\, T:\, U:\, V:\, W:\, X:\, Y:\, Z:\

OK: Applicable command, RST: Command with restricted execution, NA: Non-applicable command

Function	Parallel	PLC link Ref.: page 2-179	EtherNet/IP Ref.: page 2-243	EtherCAT	PROFINET	Nonprocedure Ref.: page 2-352
Loads the scene data.	NA	OK	RST*1	NA	NA	OK
Loads the scene group data.	NA	OK	RST*1	NA	NA	OK
Loads the system data.	NA	OK	RST*1	NA	NA	OK
Loads the system + scene group 0 data.	NA	OK	RST*1	NA	NA	OK

*1. You cannot execute tag data link commands. Execute the command with message communications.

● File Save Commands

The save destination to use differs by Sensor Controller model.

When you use FH / FHV series, do not save to the any folder except RAMDisk and storage device (such as C:\Program Files\FZ). It is possible not to perform correctly due to the decrease of Scene data storage region.

Save destination	FH/FHV series
RAMDisk	C:\Data\RAMDisk
External storage	E:\, F:\, G:\, H:\, M:\, S:\, T:\, U:\, V:\, W:\, X:\, Y:\, Z:\

OK: Applicable command, RST: Command with restricted execution, NA: Non-applicable command

Function	Parallel	PLC link Ref.: page 2-180	EtherNet/IP Ref.: page 2-243	EtherCAT	PROFINET	Non-procedure Ref.: page 2-352
Saves the scene data.	NA	OK	RST*1	NA	NA	OK
Saves the scene group data.	NA	OK	RST*1	NA	NA	OK
Saves the system data.	NA	OK	RST*1	NA	NA	OK
Saves the image data stored in the the Sensor Controller's memory.	NA	OK	RST*1	NA	NA	OK
Saves all image data in the Sensor Controller's memory with ifz format in external storage.	NA	OK	RST*1	NA	NA	OK
Saves the last logging image.	NA	OK	RST*1	NA	NA	OK

Function	Parallel	PLC link Ref.: page 2-180	EtherNet/IP Ref.: page 2-243	EtherCAT	PROFINET	Non-procedure Ref.: page 2-352
Saves the system + scene group 0 data that is currently used by the Sensor Controller in a file.	NA	OK	RST*1	NA	NA	OK
Captures the screen.	NA	OK	RST*1	NA	NA	OK

*1. You cannot execute tag data link commands. Execute the command with message communications.



A-1-4 Command Details for PLC Link, EtherNet/IP, EtherCAT, and PROFINET

This section provides details on the communications commands.

Single Measurement

Performs measurement one time.

Command (PLC to Sensor Controller)

First word in Command Area	Hexadecimal notation	Bit				Description
		15 - 12	11 - 8	7 - 4	3 - 0	
+2	1010	0001	0000	0001	0000	Command code
+3	0010	0000	0000	0001	0000	

Response (Sensor Controller to PLC)

First word in Response Area	Hexadecimal notation	Bit				Description
		15 - 12	11 - 8	7 - 4	3 - 0	
+2	1010	0001	0000	0001	0000	Command code
+3	0010	0000	0000	0001	0000	Response target command codes
+4	-	0000	0000	0000	0000	Response code
+5	-	0000	0000	0000	0000	Command execution result OK: 0 (0000 0000) NG: Not 0 (0000 0000)

Start Continuous Measurements

Performs continuous measurement.

Command (PLC to Sensor Controller)

First word in Command Area	Hexadecimal notation	Bit				Description
		15 - 12	11 - 8	7 - 4	3 - 0	
+2	1020	0001	0000	0010	0000	Command code
+3	0010	0000	0000	0001	0000	

Response (Sensor Controller to PLC)

First word in Response Area	Hexadecimal notation	Bit				Description
		15 - 12	11 - 8	7 - 4	3 - 0	
+2	1020	0001	0000	0010	0000	Command code
+3	0010	0000	0000	0001	0000	Response target command codes

First word in Response Area	Hexadecimal notation	Bit				Description
		15 - 12	11 - 8	7 - 4	3 - 0	
+4	-	0000	0000	0000	0000	Response code
+5	-	0000	0000	0000	0000	Command execution result OK: 0 (0000 0000) NG: Not 0 (0000 0000)

End Continuous Measurements

Ends continuous measurements.

Command (PLC to Sensor Controller)

First word in Command Area	Hexadecimal notation	Bit				Description
		15 - 12	11 - 8	7 - 4	3 - 0	
+2	1030	0001	0000	0011	0000	Command code
+3	0010	0000	0000	0001	0000	

Response (Sensor Controller to PLC)

First word in Response Area	Hexadecimal notation	Bit				Description
		15 - 12	11 - 8	7 - 4	3 - 0	
+2	1030	0001	0000	0011	0000	Command code
+3	0010	0000	0000	0001	0000	Response target command codes
+4	-	0000	0000	0000	0000	Response code
+5	-	0000	0000	0000	0000	Command execution result OK: 0 (0000 0000) NG: Not 0 (0000 0000)

Execute Unit Test

Performs test measurement for the specified unit.

Command (PLC to Sensor Controller)

First word in Command Area	Hexadecimal notation	Bit				Description
		15 - 12	11 - 8	7 - 4	3 - 0	
+2	1040	0001	0000	0100	0000	Command code
+3	0010	0000	0000	0001	0000	
+4	-	0000	0000	0000	0000	Unit No.
+5	-	0000	0000	0000	0000	



Precautions for Correct Use

You cannot use the Unit Stand-alone Test Measurement Execution command for the following Camera Image Input processing units.

- Camera Image Input, Camera Image Input GigE, Camera Image Input FH, Camera Image Input FHV, Camera Image Input HDR, and Camera Image Input HDR Lite.

Response (Sensor Controller to PLC)

First word in Response Area	Hexadecimal notation	Bit				Description
		15 - 12	11 - 8	7 - 4	3 - 0	
+2	1040	0001	0000	0100	0000	Command code
+3	0010	0000	0000	0001	0000	Response target command codes
+4	-	0000	0000	0000	0000	Response code
+5	-	0000	0000	0000	0000	Command execution result OK: 0 (0000 0000) NG: Not 0 (0000 0000)

Clear Measurement Values

Clears all measurement result values.

Command (PLC to Sensor Controller)

First word in Command Area	Hexadecimal notation	Bit				Description
		15 - 12	11 - 8	7 - 4	3 - 0	
+2	2010	0010	0000	0001	0000	Command code
+3	0010	0000	0000	0001	0000	

Response (Sensor Controller to PLC)

First word in Response Area	Hexadecimal notation	Bit				Description
		15 - 12	11 - 8	7 - 4	3 - 0	
+2	2010	0010	0000	0001	0000	Command code
+3	0010	0000	0000	0001	0000	Response target command codes
+4	-	0000	0000	0000	0000	Response code
+5	-	0000	0000	0000	0000	Command execution result OK: 0 (0000 0000) NG: Not 0 (0000 0000)

Clear Data Output Buffer

Clears the data output buffer.

Command (PLC to Sensor Controller)

First word in Command Area	Hexadecimal notation	Bit				Description
		15 - 12	11 - 8	7 - 4	3 - 0	
+2	2020	0010	0000	0010	0000	Command code
+3	0010	0000	0000	0001	0000	

Response (Sensor Controller to PLC)

First word in Response Area	Hexadecimal notation	Bit				Description
		15 - 12	11 - 8	7 - 4	3 - 0	
+2	2020	0010	0000	0010	0000	Command code
+3	0010	0000	0000	0001	0000	Response target command codes
+4	-	0000	0000	0000	0000	Response code
+5	-	0000	0000	0000	0000	Command execution result OK: 0 (0000 0000) NG: Not 0 (0000 0000)

Clear I/O Output Memory

Clears the data output buffer and Output Area, and the value becomes **0**.

Does not include User Area.

Result_Notification turns ON to update the Output Area.

Output control will be set to *None*.



Precautions for Correct Use

This command is exclusive EtherCAT

Command (PLC to Sensor Controller)

First word in Command Area	Hexadecimal notation	Bit				Description
		15 - 12	11 - 8	7 - 4	3 - 0	
+2	2030	0010	0000	0011	0000	Command code
+3	0010	0000	0000	0001	0000	

Response (Sensor Controller to PLC)

First word in Response Area	Hexadecimal notation	Bit				Description
		15 - 12	11 - 8	7 - 4	3 - 0	
+2	2030	0010	0000	0011	0000	Command code Response target command codes
+3	0010	0000	0000	0001	0000	
+4	—	0000	0000	0000	0000	Response code Command execution result OK: 0 (0000 0000) NG: Not 0 (0000 0000)
+5	—	0000	0000	0000	0000	

Clear Measurement State

Clears all measured values for the currently displayed scene.

Clears the data output buffer and Output Area, and the value becomes **0**.

Does not include User Area.

Result_Notification turns ON to update the Output Area.

Output control will be set to *None*.



Precautions for Correct Use

This command is exclusive EtherCAT

Command (PLC to Sensor Controller)

First word in Command Area	Hexadecimal notation	Bit				Description
		15 - 12	11 - 8	7 - 4	3 - 0	
+2	2040	0010	0000	0100	0000	Command code
+3	0010	0000	0000	0001	0000	

Response (Sensor Controller to PLC)

First word in Response Area	Hexadecimal notation	Bit				Description
		15 - 12	11 - 8	7 - 4	3 - 0	
+2	2040	0010	0000	0100	0000	Command code Response target command codes
+3	0010	0000	0000	0001	0000	
+4	—	0000	0000	0000	0000	Response code Command execution result OK: 0 (0000 0000) NG: Not 0 (0000 0000)
+5	—	0000	0000	0000	0000	

Save Data in Sensor Controller

Saves the current system data and scene group data in the Sensor Controller.

Command (PLC to Sensor Controller)

First word in Command Area	Hexadecimal notation	Bit				Description
		15 - 12	11 - 8	7 - 4	3 - 0	
+2	3010	0011	0000	0001	0000	Command code
+3	0010	0000	0000	0001	0000	

Response (Sensor Controller to PLC)

First word in Response Area	Hexadecimal notation	Bit				Description
		15 - 12	11 - 8	7 - 4	3 - 0	
+2	3010	0011	0000	0001	0000	Command code
+3	0010	0000	0000	0001	0000	Response target command codes
+4	-	0000	0000	0000	0000	Response code
+5	-	0000	0000	0000	0000	Command execution result OK: 0 (0000 0000) NG: Not 0 (0000 0000)

Re-register Model

Registers the model again.

Command (PLC to Sensor Controller)

First word in Command Area	Hexadecimal notation	Bit				Description
		15 - 12	11 - 8	7 - 4	3 - 0	
+2	4010	0100	0000	0001	0000	Command code
+3	0010	0000	0000	0001	0000	
+4	-	0000	0000	0000	0000	Unit No.
+5	-	0000	0000	0000	0000	
+6	-	0000	0000	0000	0000	Model No.
+7	-	0000	0000	0000	0000	

First word in Command Area	Hexadecimal notation	Bit				Description
		15 - 12	11 - 8	7 - 4	3 - 0	
+8	-	0000	0000	0000	0000	Specifies the target data. When the setting value is expressed in binary, if bit 0 of the first word in the Command Area + 8 is 1, the model is re-registered. When the setting value is expressed in binary, if the bit 1 is 1, the reference position is updated. When the setting value is expressed in binary, if the bit 2 is 1, the detection position is updated. Example) 011: To re-register/update the model and reference position 101: To re-register/update the model and detection point 111: To re-register/update everything
+9	-	0000	0000	0000	0000	

Response (Sensor Controller to PLC)

First word in Response Area	Hexadecimal notation	Bit				Description
		15 - 12	11 - 8	7 - 4	3 - 0	
+2	4010	0100	0000	0001	0000	Command code Response target command codes
+3	0010	0000	0000	0001	0000	
+4	-	0000	0000	0000	0000	Response code Command execution result OK: 0 (0000 0000) NG: Not 0 (0000 0000)
+5	-	0000	0000	0000	0000	

Scroll

The image display window whose number is specified is moved to the specified distance in parallel. The setting range for the movement distance is not restricted. Also, because the scale for movement is independent of the display zoom ratio, the movement is not affected by change in the zoom ratio.

Command (PLC to Sensor Controller)

First word in Command Area	Hexadecimal notation	Bit				Description
		15 - 12	11 - 8	7 - 4	3 - 0	
+2	5010	0101	0000	0001	0000	Command code
+3	0010	0000	0000	0001	0000	

First word in Command Area	Hexadecimal notation	Bit				Description
		15 - 12	11 - 8	7 - 4	3 - 0	
+4	-	0000	0000	0000	0000	Display image window number
+5	-	0000	0000	0000	0000	
+6	-	0000	0000	0000	0000	X movement distance (camera coordinate)
+7	-	0000	0000	0000	0000	
+8	-	0000	0000	0000	0000	Y movement distance (camera coordinate)
+9	-	0000	0000	0000	0000	

Response (Sensor Controller to PLC)

First word in Response Area	Hexadecimal notation	Bit				Description
		15 - 12	11 - 8	7 - 4	3 - 0	
+2	5010	0101	0000	0001	0000	Command code
+3	0010	0000	0000	0001	0000	Response target command codes
+4	-	0000	0000	0000	0000	Response code
+5	-	0000	0000	0000	0000	Command execution result OK: 0 (0000 0000) NG: Not 0 (0000 0000)

Zoom

Zooms the image display window whose number is specified in or out to the specified zoom ratio. The zoom ratio here is the ratio compared to the original image (100%).

Command (PLC to Sensor Controller)

First word in Command Area	Hexadecimal notation	Bit				Description
		15 - 12	11 - 8	7 - 4	3 - 0	
+2	5020	0101	0000	0010	0000	Command code
+3	0010	0000	0000	0001	0000	
+4	-	0000	0000	0000	0000	Display image window number
+5	-	0000	0000	0000	0000	
+6	-	0000	0000	0000	0000	Sets magnification. (Value multiplied by 1000) Example) 25%: Enter 250 (0.25 × 1,000) 1,600%: Enter 16000 (16 × 1,000)
+7	-	0000	0000	0000	0000	

Response (Sensor Controller to PLC)

First word in Response Area	Hexadecimal notation	Bit				Description
		15 - 12	11 - 8	7 - 4	3 - 0	
+2	5020	0101	0000	0010	0000	Command code
+3	0010	0000	0000	0001	0000	Response target command codes

First word in Response Area	Hexadecimal notation	Bit				Description
		15 - 12	11 - 8	7 - 4	3 - 0	
+4	-	0000	0000	0000	0000	Response code Command execution result OK: 0 (0000 0000) NG: Not 0 (0000 0000)
+5	-	0000	0000	0000	0000	

Fit

Returns the display position and display zoom ratio for the image display window to their default values.

Command (PLC to Sensor Controller)

First word in Command Area	Hexadecimal notation	Bit				Description
		15 - 12	11 - 8	7 - 4	3 - 0	
+2	5030	0101	0000	0011	0000	Command code
+3	0010	0000	0000	0001	0000	
+4	-	0000	0000	0000	0000	Display image window number Image display window number (0 to 23)
+5	-	0000	0000	0000	0000	

Response (Sensor Controller to PLC)

First word in Response Area	Hexadecimal notation	Bit				Description
		15 - 12	11 - 8	7 - 4	3 - 0	
+2	5030	0101	0000	0011	0000	Command code Response target command codes
+3	0010	0000	0000	0001	0000	
+4	-	0000	0000	0000	0000	Response code Command execution result OK: 0 (0000 0000) NG: Not 0 (0000 0000)
+5	-	0000	0000	0000	0000	

Copy Scene Data

Copies the data for the scene with the number specified with command argument 1 to the scene with the number specified with command argument 2. If there is already data at the copy destination, the copied data is written over that data.

Command (PLC to Sensor Controller)

First word in Command Area	Hexadecimal notation	Bit				Description
		15 - 12	11 - 8	7 - 4	3 - 0	
+2	7010	0111	0000	0001	0000	Command code
+3	0010	0000	0000	0001	0000	
+4	-	0000	0000	0000	0000	Copy source scene No.
+5	-	0000	0000	0000	0000	
+6	-	0000	0000	0000	0000	Copy destination scene No.
+7	-	0000	0000	0000	0000	

Response (Sensor Controller to PLC)

First word in Response Area	Hexadecimal notation	Bit				Description
		15 - 12	11 - 8	7 - 4	3 - 0	
+2	7010	0111	0000	0001	0000	Command code
+3	0010	0000	0000	0001	0000	Response target command codes
+4	-	0000	0000	0000	0000	Response code
+5	-	0000	0000	0000	0000	Command execution result OK: 0 (0000 0000) NG: Not 0 (0000 0000)

Delete Scene Data

Deletes the data for the scene whose number is specified with command argument 1.

Command (PLC to Sensor Controller)

First word in Command Area	Hexadecimal notation	Bit				Description
		15 - 12	11 - 8	7 - 4	3 - 0	
+2	7020	0111	0000	0010	0000	Command code
+3	0010	0000	0000	0001	0000	
+4	-	0000	0000	0000	0000	Number of the scene to delete
+5	-	0000	0000	0000	0000	

Response (Sensor Controller to PLC)

First word in Response Area	Hexadecimal notation	Bit				Description
		15 - 12	11 - 8	7 - 4	3 - 0	
+2	7020	0111	0000	0010	0000	Command code Response target command codes
+3	0010	0000	0000	0001	0000	
+4	-	0000	0000	0000	0000	Response code Command execution result OK: 0 (0000 0000) NG: Not 0 (0000 0000)
+5	-	0000	0000	0000	0000	

Move Scene Data

Copies the data for the scene with the number specified with command argument 1 to the scene with the number specified with command argument 2.

Deletes scene data with a number specified by command argument 1 after completing copying. If there is already data at the copy destination, the copied data is written over that data.

Command (PLC to Sensor Controller)

First word in Command Area	Hexadecimal notation	Bit				Description
		15 - 12	11 - 8	7 - 4	3 - 0	
+2	7030	0111	0000	0011	0000	Command code
+3	0010	0000	0000	0001	0000	
+4	-	0000	0000	0000	0000	Source scene number
+5	-	0000	0000	0000	0000	
+6	-	0000	0000	0000	0000	Target scene number
+7	-	0000	0000	0000	0000	

Response (Sensor Controller to PLC)

First word in Response Area	Hexadecimal notation	Bit				Description
		15 - 12	11 - 8	7 - 4	3 - 0	
+2	7030	0111	0000	0011	0000	Command code Response target command codes
+3	0010	0000	0000	0001	0000	
+4	-	0000	0000	0000	0000	Response code Command execution result OK: 0 (0000 0000) NG: Not 0 (0000 0000)
+5	-	0000	0000	0000	0000	

Register Image Data

Registers the specified image data as a registered image.

After the command is executed, the status will be the same as when the image was registered with the Registered Image Manager. If the source is the last measured image (0), command argument 3 (logged image number of file name) can be omitted.

Command (PLC to Sensor Controller)

First word in Command Area	Hexadecimal notation	Bit				Description
		15 - 12	11 - 8	7 - 4	3 - 0	
+2	8010	1000	0000	0001	0000	Command code
+3	0010	0000	0000	0001	0000	
+4	-	0000	0000	0000	0000	Any data (000 to 999)
+5	-	0000	0000	0000	0000	
+6	-	0000	0000	0000	0000	Data type of source 0: Last measured image 1: Logged image 2: Image file
+7	-	0000	0000	0000	0000	
+8	-	0000	0000	0000	0000	Logged image number or file name
+9	-	0000	0000	0000	0000	
:	-	0000	0000	0000	0000	When the source is a logged image, specify the logging file number. (0 to Number of logged images in Controller - 1) When the source is an image file, specify a file name containing an extension of 1 to 256 characters. The file will be registered with the same extension as the specified registration-source file. If a file having an extension other than ifz, bfz, and bmp is specified, it will result in an error.

Response (Sensor Controller to PLC)

First word in Response Area	Hexadecimal notation	Bit				Description
		15 - 12	11 - 8	7 - 4	3 - 0	
+2	8010	1000	0000	0001	0000	Command code
+3	0010	0000	0000	0001	0000	Response target command codes
+4	-	0000	0000	0000	0000	Response code
+5	-	0000	0000	0000	0000	Command execution result OK: 0 (0000 0000) NG: Not 0 (0000 0000)

Load Registered Image

Loads the specified registered image as the measurement image.

After the command is executed, the status will be the same as when the image was loaded with the Registered Image Manager.

Command (PLC to Sensor Controller)

First word in Command Area	Hexadecimal notation	Bit				Description
		15 - 12	11 - 8	7 - 4	3 - 0	
+2	8020	1000	0000	0010	0000	Command code
+3	0010	0000	0000	0001	0000	
+4	-	0000	0000	0000	0000	Registered image number (000 to 999) If there are multiple files with the same image file name as the registered image number but different image types, the files are searched in the order of ifz, bfz, and bmp and the first matching image is read.
+5	-	0000	0000	0000	0000	

Response (Sensor Controller to PLC)

First word in Response Area	Hexadecimal notation	Bit				Description
		15 - 12	11 - 8	7 - 4	3 - 0	
+2	8020	1000	0000	0010	0000	Command code
+3	0010	0000	0000	0001	0000	Response target command codes
+4	-	0000	0000	0000	0000	Response code
+5	-	0000	0000	0000	0000	Command execution result OK: 0 (0000 0000) NG: Not 0 (0000 0000)

Echo

Returns an entered text string without changing it.

Command argument 1 is alphanumeric only.

Responds in the response areas +6+7 with the data that was set in command areas +4+5.

Command (PLC to Sensor Controller)

First word in Command Area	Hexadecimal notation	Bit				Description
		15 - 12	11 - 8	7 - 4	3 - 0	
+2	9010	1001	0000	0001	0000	Command code
+3	0010	0000	0000	0001	0000	
+4	-	0000	0000	0000	0000	Any data (2 words)
+5	-	0000	0000	0000	0000	

Response (Sensor Controller to PLC)

First word in Response Area	Hexadecimal notation	Bit				Description
		15 - 12	11 - 8	7 - 4	3 - 0	
+2	9010	1001	0000	0001	0000	Command code
+3	0010	0000	0000	0001	0000	Response target command codes
+4	-	0000	0000	0000	0000	Response code
+5	-	0000	0000	0000	0000	Command execution result OK: 0 (0000 0000) NG: Not 0 (0000 0000)
+6	-	0000	0000	0000	0000	Response data
+7	-	0000	0000	0000	0000	Any data (2 words)

Add User Account

Adds a user account to a specified group ID.

If the group ID for the account of the user currently logging in belongs is not 0, a command error occurs.

If the user account to be set has already existed, it will be overwritten with the new account.

Command (PLC to Sensor Controller)

First word in Command Area	Hexadecimal notation	Bit				Description
		15 - 12	11 - 8	7 - 4	3 - 0	
+2	a010	1010	0000	0001	0000	Command code
+3	0010	0000	0000	0001	0000	
+4	-	0000	0000	0000	0000	Group ID 0 to 7 to which the user account to be added belongs.
+5	-	0000	0000	0000	0000	
+6	-	0000	0000	0000	0000	User name of the user account to add
:	-	0000	0000	0000	0000	
+21	-	0000	0000	0000	0000	Single-byte alphanumeric characters: 2 to 20 characters
+22	-	0000	0000	0000	0000	Password of user account to add
:	-	0000	0000	0000	0000	
+37	-	0000	0000	0000	0000	
+38	-	0000	0000	0000	0000	User name of the user account (UG0) that has the right to add user accounts.
:	-	0000	0000	0000	0000	
+53	-	0000	0000	0000	0000	
+54	-	0000	0000	0000	0000	Password (UG0)
:	-	0000	0000	0000	0000	
+70	-	0000	0000	0000	0000	

Response (Sensor Controller to PLC)

First word in Response Area	Hexadecimal notation	Bit				Description
		15 - 12	11 - 8	7 - 4	3 - 0	
+2	a010	1010	0000	0010	0000	Command code Response target command codes
+3	0010	0000	0000	0001	0000	
+4	-	0000	0000	0000	0000	Response code Command execution result OK: 0 (0000 0000) NG: Not 0 (0000 0000)
+5	-	0000	0000	0000	0000	

Delete User Account

Deletes a specified user account.

If the group ID for the account of the user currently logging in belongs is not 0, a command error occurs.

If the user account to be set has already existed, it will be overwritten with the new account.

If the specified user account does not exist, a command acknowledge returns.

Command (PLC to Sensor Controller)

First word in Command Area	Hexadecimal notation	Bit				Description
		15 - 12	11 - 8	7 - 4	3 - 0	
+2	a020	1010	0000	0010	0000	Command code
+3	0010	0000	0000	0001	0000	
+4	-	0000	0000	0000	0000	User name of the user account to delete
:	-	0000	0000	0000	0000	
+19	-	0000	0000	0000	0000	
+20	-	0000	0000	0000	0000	User name of the user account (UG0) that has the right to delete user accounts
:	-	0000	0000	0000	0000	
+35	-	0000	0000	0000	0000	
+36	-	0000	0000	0000	0000	Password (UG0)
:	-	0000	0000	0000	0000	
+52	-	0000	0000	0000	0000	

Response (Sensor Controller to PLC)

First word in Response Area	Hexadecimal notation	Bit				Description
		15 - 12	11 - 8	7 - 4	3 - 0	
+2	a020	1010	0000	0010	0000	Command code Response target command codes
+3	0010	0000	0000	0001	0000	
+4	-	0000	0000	0000	0000	Response code Command execution result OK: 0 (0000 0000) NG: Not 0 (0000 0000)
+5	-	0000	0000	0000	0000	

Return to Start of Flow

Branches to the start of the measurement flow (processing unit 0). Only supports execution of commands in the flow.

Command (PLC to Sensor Controller)

First word in Command Area	Hexadecimal notation	Bit				Description
		15 - 12	11 - 8	7 - 4	3 - 0	
+2	b010	1011	0000	0001	0000	Command code
+3	0010	0000	0000	0001	0000	

Response (Sensor Controller to PLC)

First word in Response Area	Hexadecimal notation	Bit				Description
		15 - 12	11 - 8	7 - 4	3 - 0	
+2	b010	1011	0000	0001	0000	Command code
+3	0010	0000	0000	0001	0000	Response target command codes
+4	-	0000	0000	0000	0000	Response code
+5	-	0000	0000	0000	0000	Command execution result OK: 0 (0000 0000) NG: Not 0 (0000 0000)

Restart

Restarts the Sensor Controller.



Precautions for Correct Use

When the Restart command is executed, BUSY does not turn off even after the command execution bit turns off.

After the Restart command is executed, perform a memory clear of BUSY on the PLC side.

Command (PLC to Sensor Controller)

First word in Command Area	Hexadecimal notation	Bit				Description
		15 - 12	11 - 8	7 - 4	3 - 0	
+2	f010	1111	0000	0001	0000	Command code
+3	0010	0000	0000	0001	0000	

Response (Sensor Controller to PLC)

There is no response because restarting is performed.

Get Scene Number

Gets the current scene number.

Command (PLC to Sensor Controller)

First word in Command Area	Hexadecimal notation	Bit				Description
		15 - 12	11 - 8	7 - 4	3 - 0	
+2	1000	0001	0000	0000	0000	Command code
+3	0020	0000	0000	0010	0000	

Response (Sensor Controller to PLC)

First word in Response Area	Hexadecimal notation	Bit				Description
		15 - 12	11 - 8	7 - 4	3 - 0	
+2	1000	0001	0000	0000	0000	Command code
+3	0020	0000	0000	0010	0000	Response target command codes
+4	-	0000	0000	0000	0000	Response code
+5	-	0000	0000	0000	0000	Command execution result OK: 0 (0000 0000) NG: Not 0 (0000 0000)
+6	-	0000	0000	0000	0000	Response data
+7	-	0000	0000	0000	0000	Got scene No.

Get Scene Group Number

Gets the current scene group number.

Command (PLC to Sensor Controller)

First word in Command Area	Hexadecimal notation	Bit				Description
		15 - 12	11 - 8	7 - 4	3 - 0	
+2	2000	0010	0000	0000	0000	Command code
+3	0020	0000	0000	0010	0000	

Response (Sensor Controller to PLC)

First word in Response Area	Hexadecimal notation	Bit				Description
		15 - 12	11 - 8	7 - 4	3 - 0	
+2	2000	0010	0000	0000	0000	Command code
+3	0020	0000	0000	0010	0000	Response target command codes
+4	-	0000	0000	0000	0000	Response code
+5	-	0000	0000	0000	0000	Command execution result OK: 0 (0000 0000) NG: Not 0 (0000 0000)

First word in Response Area	Hexadecimal notation	Bit				Description
		15 - 12	11 - 8	7 - 4	3 - 0	
+6	-	0000	0000	0000	0000	Response data
+7	-	0000	0000	0000	0000	Got scene group No.

Get Layout Number

Gets the number of the layout that is currently displayed.

Command (PLC to Sensor Controller)

First word in Command Area	Hexadecimal notation	Bit				Description
		15 - 12	11 - 8	7 - 4	3 - 0	
+2	4000	0100	0000	0000	0000	Command code
+3	0020	0000	0000	0010	0000	
+4	-	0000	0000	0000	0000	Item to get 0: Local 1: Remote
+5	-	0000	0000	0000	0000	



Precautions for Correct Use

For non-remote operation, only 0: Local can be specified. For remote operation, only 1: Remote can be specified.

If any combination other than the above is used, unexpected operation may occur when the command is executed.

Response (Sensor Controller to PLC)

First word in Response Area	Hexadecimal notation	Bit				Description
		15 - 12	11 - 8	7 - 4	3 - 0	
+2	4000	0100	0000	0000	0000	Command code
+3	0020	0000	0000	0010	0000	Response target command codes
+4	-	0000	0000	0000	0000	Response code
+5	-	0000	0000	0000	0000	Command execution result OK: 0 (0000 0000) NG: Not 0 (0000 0000)
+6	-	0000	0000	0000	0000	Response data
+7	-	0000	0000	0000	0000	Current layout number (0 to 8)

Get Display Image Unit Number

Gets the number of the Unit that is currently displayed in the specified image display window.

Command (PLC to Sensor Controller)

First word in Command Area	Hexadecimal notation	Bit				Description
		15 - 12	11 - 8	7 - 4	3 - 0	
+2	5010	0101	0000	0001	0000	Command code
+3	0020	0000	0000	0010	0000	
+4	-	0000	0000	0000	0000	Display image window number Image display window number (0 to 23)
+5	-	0000	0000	0000	0000	

Response (Sensor Controller to PLC)

First word in Response Area	Hexadecimal notation	Bit				Description
		15 - 12	11 - 8	7 - 4	3 - 0	
+2	5010	0101	0000	0001	0000	Command code
+3	0020	0000	0000	0010	0000	Response target command codes
+4	-	0000	0000	0000	0000	Response code
+5	-	0000	0000	0000	0000	Command execution result OK: 0 (0000 0000) NG: Not 0 (0000 0000)
+6	-	0000	0000	0000	0000	Response data
+7	-	0000	0000	0000	0000	Unit No.

Get Display Sub-image Number

Gets the sub-image number that is currently displayed in the specified image display window.

Command (PLC to Sensor Controller)

First word in Command Area	Hexadecimal notation	Bit				Description
		15 - 12	11 - 8	7 - 4	3 - 0	
+2	5020	0101	0000	0010	0000	Command code
+3	0020	0000	0000	0010	0000	
+4	-	0000	0000	0000	0000	Display image window number Image display window number (0 to 23)
+5	-	0000	0000	0000	0000	

Response (Sensor Controller to PLC)

First word in Response Area	Hexadecimal notation	Bit				Description
		15 - 12	11 - 8	7 - 4	3 - 0	
+2	5020	0101	0000	0010	0000	Command code
+3	0020	0000	0000	0010	0000	Response target command codes
+4	-	0000	0000	0000	0000	Response code
+5	-	0000	0000	0000	0000	Command execution result OK: 0 (0000 0000) NG: Not 0 (0000 0000)
+6	-	0000	0000	0000	0000	Response data
+7	-	0000	0000	0000	0000	Sub image number

Get Image Display Status

Gets the image mode for the specified image display window.

Command (PLC to Sensor Controller)

First word in Command Area	Hexadecimal notation	Bit				Description
		15 - 12	11 - 8	7 - 4	3 - 0	
+2	5030	0101	0000	0011	0000	Command code
+3	0020	0000	0000	0010	0000	
+4	-	0000	0000	0000	0000	Display image window number
+5	-	0000	0000	0000	0000	Image display window number (0 to 23)

Response (Sensor Controller to PLC)

First word in Response Area	Hexadecimal notation	Bit				Description
		15 - 12	11 - 8	7 - 4	3 - 0	
+2	5030	0101	0000	0011	0000	Command code
+3	0020	0000	0000	0010	0000	Response target command codes
+4	-	0000	0000	0000	0000	Response code
+5	-	0000	0000	0000	0000	Command execution result OK: 0 (0000 0000) NG: Not 0 (0000 0000)
+6	-	0000	0000	0000	0000	Response data
+7	-	0000	0000	0000	0000	Image mode 0: Through 1: Freeze 2: Last NG

Get Communications Input Status

Gets the input status (prohibited/permited) for the Communications Modules.

Command (PLC to Sensor Controller)

First word in Command Area	Hexadecimal notation	Bit				Description
		15 - 12	11 - 8	7 - 4	3 - 0	
+2	7010	0111	0000	0001	0000	Command code
+3	0020	0000	0000	0010	0000	
+4	-	0000	0000	0000	0000	Communication module types 0: Serial (Ethernet) 1: Serial (RS-232C) 2: Parallel I/O 3: Fieldbus 4: Remote operation
+5	-	0000	0000	0000	0000	

Response (Sensor Controller to PLC)

First word in Response Area	Hexadecimal notation	Bit				Description
		15 - 12	11 - 8	7 - 4	3 - 0	
+2	7010	0111	0000	0001	0000	Command code
+3	0020	0000	0000	0010	0000	Response target command codes
+4	-	0000	0000	0000	0000	Response code
+5	-	0000	0000	0000	0000	Command execution result OK: 0 (0000 0000) NG: Not 0 (0000 0000)
+6	-	0000	0000	0000	0000	Response data
+7	-	0000	0000	0000	0000	Input state 0: Prohibited 1: Permitted

Get Communications Output Status

Gets the output status (prohibited/permited) to an external device.

Command (PLC to Sensor Controller)

First word in Command Area	Hexadecimal notation	Bit				Description
		15 - 12	11 - 8	7 - 4	3 - 0	
+2	7020	0111	0000	0010	0000	Command code
+3	0020	0000	0000	0010	0000	

Response (Sensor Controller to PLC)

First word in Response Area	Hexadecimal notation	Bit				Description
		15 - 12	11 - 8	7 - 4	3 - 0	
+2	7020	0111	0000	0010	0000	Command code
+3	0020	0000	0000	0010	0000	Response target command codes
+4	-	0000	0000	0000	0000	Response code
+5	-	0000	0000	0000	0000	Command execution result OK: 0 (0000 0000) NG: Not 0 (0000 0000)
+6	-	0000	0000	0000	0000	Response data
+7	-	0000	0000	0000	0000	Output state 0: Prohibited 1: Permitted

Get Parallel Terminal Status

Gets the ON/OFF status for the specified parallel I/O terminal.

Set the parallel I/O terminals with the terminal type and number.

For how to set, refer to the following example and the description in the table.

Example:

When you want to get the terminal status of STEP0 in Line 0.

1. Select 0 in the terminal type. STEP is set.
2. Select 0 in the terminal number, STEP0 of Line0 is set.
3. Send the settings specified in the above step 1 and 2 to the specified port number of Line0.
4. The specified terminal status will be responded.

Command (PLC to Sensor Controller)

First word in Command Area	Hexadecimal notation	Bit				Description
		15 - 12	11 - 8	7 - 4	3 - 0	
+2	8010	1000	0000	0001	0000	Command code
+3	0020	0000	0000	0010	0000	
+4	-	0000	0000	0000	0000	Terminal type:
+5	-	0000	0000	0000	0000	Set the terminal by combining the Terminal number. Specified terminal differs according to the Sensor Controller series. For details, refer to*1.
+6	-	0000	0000	0000	0000	Terminal number:
+7	-	0000	0000	0000	0000	Set the terminal by combining the Terminal type. Specified terminal differs according to the Sensor Controller series. For details, refer to*1.

Response (Sensor Controller to PLC)

First word in Response Area	Hexadecimal notation	Bit				Description
		15 - 12	11 - 8	7 - 4	3 - 0	
+2	8010	1000	0000	0001	0000	Command code Response target command codes
+3	0020	0000	0000	0010	0000	
+4	-	0000	0000	0000	0000	Response code Command execution result OK: 0 (0000 0000) NG: Not 0 (0000 0000)
+5	-	0000	0000	0000	0000	
+6	-	0000	0000	0000	0000	Response data Terminal status 0:OFF 1:ON
+7	-	0000	0000	0000	0000	

*1. Terminal type and Terminal number

FH-2000 / FH-5000 series Sensor Controller

Terminal type		Terminal number							
		0	1	2	3	4	5	6	7
STEP	0	STEP0	STEP1	STEP2	STEP3	STEP4	STEP5	STEP6	STEP7
DSA	1	DSA0	DSA1	-	-	-	-	-	-
DI	2	DI0	DI1	DI2	DI3	DI4	DI5	DI6	DI7
DI_LINE	11	DILINE0	DILINE1	DILINE2	-	-	-	-	-

FH-L/FHV series Sensor Controller

Terminal type		Terminal number							
		0	1	2	3	4	5	6	7
STEP	0	STEP0	-	-	-	-	-	-	-
DSA	1	DSA0	-	-	-	-	-	-	-
DI	2	DI0	DI1	DI2	DI3	DI4	DI5	DI6	DI7
DI_LINE	11	-	-	-	-	-	-	-	-



Precautions for Correct Use

- When the Multi-line Random-trigger mode is selected in the following series, usable signal type or assignment are differ depending on the used number of Lines.
 - FH-2000 series
 - FH-5000 series
 For more details of Operation mode, refer to *Multi-line Random-trigger Mode Signal Specifications* on page 2-391.
- The terminal status of each line can be got by sending this command to the port number allocated to them. For signals that are common in all lines, the terminal status can be got from any line used.

When the terminal status for an unusable line or a different line was got, the response code will be OK and the response data will always be 0.

Check the status of the received data by changing the actual parallel terminal status.

Get All Parallel Terminal Status

Gets the ON/OFF status of all parallel terminals except for DI terminals.

For how to set, refer to the following example and the description in the table.

Example:

When you want to get the terminal status except DI terminal of Line 0.

1. Send a command to get the all of the terminal status to the specified port number of Line0.
2. All of the parallel terminal status except DI are responded.

Command (PLC to Sensor Controller)

First word in Command Area	Hexadecimal notation	Bit				Description
		15 - 12	11 - 8	7 - 4	3 - 0	
+2	8020	1000	0000	0010	0000	Command code
+3	0020	0000	0000	0010	0000	

Response (Sensor Controller to PLC)

First word in Response Area	Hexadecimal notation	Bit				Description
		15 - 12	11 - 8	7 - 4	3 - 0	
+2	8020	1000	0000	0010	0000	Command code
+3	0020	0000	0000	0010	0000	Response target command codes
+4	-	0000	0000	0000	0000	Response code
+5	-	0000	0000	0000	0000	Command execution result OK: 0 (0000 0000) NG: Not 0 (0000 0000)
+6	-	0000	0000	0000	0000	Response data
+7	-	0000	0000	0000	0000	The parallel terminal status except DI. (0: OFF / 1:ON) The parallel terminal except DI can be assigned to the BIT of Response data. This assignment differs by the Sensor Controller series or by line in use. For more details, refer to *1.

*1: Response data

FH-2000 / FH-5000 series Sensor Controller

Support-ed bit	Terminal							
	Line 0	Line 1	Line 2	Line 3	Line 4	Line 5	Line 6	Line 7
BIT0	STEP0	STEP1	STEP2	STEP3	STEP4	STEP5	STEP6	STEP7
BIT1	DSA0	DSA1	0	0	0	0	0	0
BIT2	DILINE0	DILINE0	DILINE0	DILINE0	DILINE0	DILINE0	DILINE0	DILINE0
BIT3	DILINE1	DILINE1	DILINE1	DILINE1	DILINE1	DILINE1	DILINE1	DILINE1
BIT4	DILINE2	DILINE2	DILINE2	DILINE2	DILINE2	DILINE2	DILINE2	DILINE2

Support- ed bit	Terminal							
	Line 0	Line 1	Line 2	Line 3	Line 4	Line 5	Line 6	Line 7
BIT5	0	0	0	0	0	0	0	0
BIT6	0	0	0	0	0	0	0	0
BIT7	0	0	0	0	0	0	0	0
BIT8	0	0	0	0	0	0	0	0
BIT9	0	0	0	0	0	0	0	0
BIT10	0	0	0	0	0	0	0	0
BIT11	0	0	0	0	0	0	0	0
BIT12	0	0	0	0	0	0	0	0
BIT13	0	0	0	0	0	0	0	0
BIT14	0	0	0	0	0	0	0	0
BIT15	0	0	0	0	0	0	0	0

FH-L series Sensor Controller

Support- ed bit	Terminal
	Line 0
BIT0	STEP0
BIT1	DSA0
BIT2	0
BIT3	0
BIT4	0
BIT5	0
BIT6	0
BIT7	0
BIT8	0
BIT9	0
BIT10	0
BIT11	0
BIT12	0
BIT13	0
BIT14	0
BIT15	0



Precautions for Correct Use

- When the Multi-line Random-trigger mode is selected in the following series, usable signal type or assignment are differ depending on the used number of Lines.
 - FH-2000 series
 - FH-5000 series
 For more details of Operation mode, refer to *Multi-line Random-trigger Mode Signal Specifications* on page 2-391.
- The terminal status of each line can be got by sending this command to the port number allocated to them. For signals that are common in all lines, the terminal status can be got from any line used.

When the terminal status for an unusable line or a different line was got, the response code will be OK and the response data will always be 0.

Check the status of the received data by changing the actual parallel terminal status.

Get All Parallel DI Terminal Status

Gets the ON/OFF status of all parallel DI terminals.

For how to set, refer to the following example and the description in the table.

Example:

When you want to get the Parallel DI terminal status of Line 0.

1. Send a command to get the Parallel DI terminal at once to the specified port number of Line0.
2. All of the Parallel terminal status are responded.

Command (PLC to Sensor Controller)

First word in Command Area	Hexadecimal notation	Bit				Description
		15 - 12	11 - 8	7 - 4	3 - 0	
+2	8030	1000	0000	0011	0000	Command code
+3	0020	0000	0000	0010	0000	

Response (Sensor Controller to PLC)

First word in Response Area	Hexadecimal notation	Bit				Description
		15 - 12	11 - 8	7 - 4	3 - 0	
+2	8030	1000	0000	0011	0000	Command code
+3	0020	0000	0000	0010	0000	Response target command codes
+4	-	0000	0000	0000	0000	Response code
+5	-	0000	0000	0000	0000	Command execution result OK: 0 (0000 0000) NG: Not 0 (0000 0000)
+6	-	0000	0000	0000	0000	Response data
+7	-	0000	0000	0000	0000	Parallel DI terminal status (0: OFF / 1: ON) The Parallel DI terminal can be assigned to the BIT of Response data. This assignment differs by the Sensor Controller series or by line in use. For more details, refer to *1.

*1. Response data

FH-2000 / FH-5000 series Sensor Controller

Supported bit	Terminal							
	Line 0	Line 1	Line 2	Line 3	Line 4	Line 5	Line 6	Line 7
BIT0	DI0	DI0	DI0	DI0	DI0	DI0	DI0	DI0
BIT1	DI1	DI1	DI1	DI1	DI1	DI1	DI1	DI1
BIT2	DI2	DI2	DI2	DI2	DI2	DI2	DI2	DI2
BIT3	DI3	DI3	DI3	DI3	DI3	DI3	DI3	DI3
BIT4	DI4	DI4	DI4	DI4	DI4	DI4	DI4	DI4

Support- ed bit	Terminal							
	Line 0	Line 1	Line 2	Line 3	Line 4	Line 5	Line 6	Line 7
BIT5	DI5	DI5	DI5	DI5	DI5	DI5	DI5	DI5
BIT6	DI6	DI6	DI6	DI6	DI6	DI6	DI6	DI6
BIT7	DI7	DI7	DI7	DI7	DI7	DI7	DI7	DI7
BIT8	0	0	0	0	0	0	0	0
BIT9	0	0	0	0	0	0	0	0
BIT10	0	0	0	0	0	0	0	0
BIT11	0	0	0	0	0	0	0	0
BIT12	0	0	0	0	0	0	0	0
BIT13	0	0	0	0	0	0	0	0
BIT14	0	0	0	0	0	0	0	0
BIT15	0	0	0	0	0	0	0	0

FH-L series Sensor Controller

Support- ed bitt	Terminal
	Line 0
BIT0	DI0
BIT1	DI1
BIT2	DI2
BIT3	DI3
BIT4	DI4
BIT5	DI5
BIT6	DI6
BIT7	DI7
BIT8	0
BIT9	0
BIT10	0
BIT11	0
BIT12	0
BIT13	0
BIT14	0
BIT15	0



Precautions for Correct Use

This command gets the terminal state of each line by specifying its port number. When getting the terminal state of an unusable line, the response code will be OK and the response data will always be 0. Check the status of the received data by changing the actual parallel terminal status.

Get Login Account Name

Gets the user name for the user account currently logged in.

Command (PLC to Sensor Controller)

First word in Command Area	Hexadecimal notation	Bit				Description
		15 - 12	11 - 8	7 - 4	3 - 0	
+2	9000	1001	0000	0000	0000	Command code
+3	0020	0000	0000	0010	0000	
+4	-	0000	0000	0000	0000	Item to be got 0: Local 1: Remote
+5	-	0000	0000	0000	0000	

Response (Sensor Controller to PLC)

First word in Response Area	Hexadecimal notation	Bit				Description
		15 - 12	11 - 8	7 - 4	3 - 0	
+2	9000	1001	0000	0000	0000	Command code Response target command codes
+3	0020	0000	0000	0010	0000	
+4	-	0000	0000	0000	0000	Response code Command execution result OK: 0 (0000 0000) NG: Not 0 (0000 0000)
+5	-	0000	0000	0000	0000	
+6	-	0000	0000	0000	0000	Response data
+7	-	0000	0000	0000	0000	Got user name

Get Logging Account Group ID

Gets the group ID for the account currently logged in.

Command (PLC to Sensor Controller)

First word in Command Area	Hexadecimal notation	Bit				Description
		15 - 12	11 - 8	7 - 4	3 - 0	
+2	9010	1001	0000	0001	0000	Command code
+3	0020	0000	0000	0010	0000	
+4	-	0000	0000	0000	0000	Item to be got 0: Local 1: Remote
+5	-	0000	0000	0000	0000	

Response (Sensor Controller to PLC)

First word in Response Area	Hexadecimal notation	Bit				Description
		15 - 12	11 - 8	7 - 4	3 - 0	
+2	9010	1001	0000	0001	0000	Command code
+3	0020	0000	0000	0010	0000	Response target command codes
+4	-	0000	0000	0000	0000	Response code
+5	-	0000	0000	0000	0000	Command execution result OK: 0 (0000 0000) NG: Not 0 (0000 0000)
+6	-	0000	0000	0000	0000	Response data
+7	-	0000	0000	0000	0000	Got affiliated group ID

Get Operation Log State

Gets the current state of the operation log.

Command (PLC to Sensor Controller)

First word in Command Area	Hexadecimal notation	Bit				Description
		15 - 12	11 - 8	7 - 4	3 - 0	
+2	a000	1010	0000	0000	0000	Command code
+3	0020	0000	0000	0010	0000	

Response (Sensor Controller to PLC)

First word in Response Area	Hexadecimal notation	Bit				Description
		15 - 12	11 - 8	7 - 4	3 - 0	
+2	a000	1010	0000	0000	0000	Command code
+3	0020	0000	0000	0010	0000	Response target command codes
+4	-	0000	0000	0000	0000	Response code
+5	-	0000	0000	0000	0000	Command execution result OK: 0 (0000 0000) NG: Not 0 (0000 0000)
+6	-	0000	0000	0000	0000	Response data
+7	-	0000	0000	0000	0000	Got Operation log state 0: OFF 1: ON

Switch Scene

Switches to the specified scene number.

Command (PLC to Sensor Controller)

First word in Command Area	Hexadecimal notation	Bit				Description
		15 - 12	11 - 8	7 - 4	3 - 0	
+2	1000	0001	0000	0000	0000	Command code
+3	0030	0000	0000	0011	0000	
+4	-	0000	0000	0000	0000	Scene No.
+5	-	0000	0000	0000	0000	

Response (Sensor Controller to PLC)

First word in Response Area	Hexadecimal notation	Bit				Description
		15 - 12	11 - 8	7 - 4	3 - 0	
+2	1000	0001	0000	0000	0000	Command code
+3	0030	0000	0000	0011	0000	Response target command codes
+4	-	0000	0000	0000	0000	Response code
+5	-	0000	0000	0000	0000	Command execution result OK: 0 (0000 0000) NG: Not 0 (0000 0000)

Switch Scene Group

Switches to the scene group with the specified number.

Command (PLC to Sensor Controller)

First word in Command Area	Hexadecimal notation	Bit				Description
		15 - 12	11 - 8	7 - 4	3 - 0	
+2	2000	0010	0000	0000	0000	Command code
+3	0030	0000	0000	0011	0000	
+4	-	0000	0000	0000	0000	Scene group No.
+5	-	0000	0000	0000	0000	

Response (Sensor Controller to PLC)

First word in Response Area	Hexadecimal notation	Bit				Description
		15 - 12	11 - 8	7 - 4	3 - 0	
+2	2000	0010	0000	0000	0000	Command code
+3	0030	0000	0000	0011	0000	Response target command codes

First word in Response Area	Hexadecimal notation	Bit				Description
		15 - 12	11 - 8	7 - 4	3 - 0	
+4	-	0000	0000	0000	0000	Response code
+5	-	0000	0000	0000	0000	Command execution result OK: 0 (0000 0000) NG: Not 0 (0000 0000)

Set Layout Number

Sets the layout number and switches the image.

Command (PLC to Sensor Controller)

First word in Command Area	Hexadecimal notation	Bit				Description
		15 - 12	11 - 8	7 - 4	3 - 0	
+2	4000	0100	0000	0000	0000	Command code
+3	0030	0000	0000	0011	0000	
+4	-	0000	0000	0000	0000	Item to be got
+5	-	0000	0000	0000	0000	0: Local 1: Remote
+6	-	0000	0000	0000	0000	Layout number
+7	-	0000	0000	0000	0000	0: Layout 0 1: Layout 1 2: Layout 2 3: Layout 3 4: Layout 4 5: Layout 5 6: Layout 6 7: Layout 7 8: Layout 8



Precautions for Correct Use

For non-remote operation, only 0: Local can be specified. For remote operation, only 1: Remote can be specified.

If any combination other than the above is used, unexpected operation may occur when the command is executed.

Response (Sensor Controller to PLC)

First word in Response Area	Hexadecimal notation	Bit				Description
		15 - 12	11 - 8	7 - 4	3 - 0	
+2	4000	0100	0000	0000	0000	Command code
+3	0030	0000	0000	0011	0000	Response target command codes
+4	-	0000	0000	0000	0000	Response code
+5	-	0000	0000	0000	0000	Command execution result OK: 0 (0000 0000) NG: Not 0 (0000 0000)

Set Display Image Unit Number

Sets the number of the Unit to display in the specified image display window.

Command (PLC to Sensor Controller)

First word in Command Area	Hexadecimal notation	Bit				Description
		15 - 12	11 - 8	7 - 4	3 - 0	
+2	5010	0101	0000	0001	0000	Command code
+3	0030	0000	0000	0011	0000	
+4	-	0000	0000	0000	0000	Display image window number
+5	-	0000	0000	0000	0000	Image display window number (0 to 23)
+6	-	0000	0000	0000	0000	Unit number (-1 to unit number of current scene -1)
+7	-	0000	0000	0000	0000	If you specify -1, <i>Define displayed unit</i> is set.

Response (Sensor Controller to PLC)

First word in Response Area	Hexadecimal notation	Bit				Description
		15 - 12	11 - 8	7 - 4	3 - 0	
+2	5010	0101	0000	0001	0000	Command code
+3	0030	0000	0000	0011	0000	Response target command codes
+4	-	0000	0000	0000	0000	Response code
+5	-	0000	0000	0000	0000	Command execution result OK: 0 (0000 0000) NG: Not 0 (0000 0000)

Set Display Sub-image Number

Sets the number of the sub-image to display in the specified image display window.

Command (PLC to Sensor Controller)

First word in Command Area	Hexadecimal notation	Bit				Description
		15 - 12	11 - 8	7 - 4	3 - 0	
+2	5020	0101	0000	0010	0000	Command code
+3	0030	0000	0000	0011	0000	
+4	-	0000	0000	0000	0000	Display image window number
+5	-	0000	0000	0000	0000	Image display window number (0 to 23)
+6	-	0000	0000	0000	0000	Sub image number
+7	-	0000	0000	0000	0000	

Response (Sensor Controller to PLC)

First word in Response Area	Hexadecimal notation	Bit				Description
		15 - 12	11 - 8	7 - 4	3 - 0	
+2	5020	0101	0000	0010	0000	Command code Response target command codes
+3	0030	0000	0000	0011	0000	
+4	-	0000	0000	0000	0000	Response code Command execution result OK: 0 (0000 0000) NG: Not 0 (0000 0000)
+5	-	0000	0000	0000	0000	

Set Image Display Status

Sets the image mode for the specified image display window.

Command (PLC to Sensor Controller)

First word in Command Area	Hexadecimal notation	Bit				Description
		15 - 12	11 - 8	7 - 4	3 - 0	
+2	5030	0101	0000	0011	0000	Command code
+3	0030	0000	0000	0011	0000	
+4	-	0000	0000	0000	0000	Display image window number Image display window number (0 to 23)
+5	-	0000	0000	0000	0000	
+6	-	0000	0000	0000	0000	Image mode 0: Through 1: Freeze 2: Last NG
+7	-	0000	0000	0000	0000	

Response (Sensor Controller to PLC)

First word in Response Area	Hexadecimal notation	Bit				Description
		15 - 12	11 - 8	7 - 4	3 - 0	
+2	5030	0101	0000	0011	0000	Command code Response target command codes
+3	0030	0000	0000	0011	0000	
+4	-	0000	0000	0000	0000	Response code Command execution result OK: 0 (0000 0000) NG: Not 0 (0000 0000)
+5	-	0000	0000	0000	0000	

Set Communications Input Status

Permits/prohibits inputs to the Communications Modules.

Any communication module whose input state is set to Prohibit (0) accepts no communications whatsoever. However, inputs related to hardware (parallel STEP signals/DSA signals and ECAT STEP, etc.) are not included in the prohibition.

Command (PLC to Sensor Controller)

First word in Command Area	Hexadecimal notation	Bit				Description
		15 - 12	11 - 8	7 - 4	3 - 0	
+2	7010	0111	0000	0001	0000	Command code
+3	0030	0000	0000	0011	0000	
+4	-	0000	0000	0000	0000	Communication module types 0: Serial (Ethernet) 1: Serial (RS-232C) 2: Parallel I/O 3: Fieldbus 4: Remote operation
+5	-	0000	0000	0000	0000	
+6	-	0000	0000	0000	0000	Input state 0: Prohibited 1: Permitted
+7	-	0000	0000	0000	0000	

Response (Sensor Controller to PLC)

First word in Response Area	Hexadecimal notation	Bit				Description
		15 - 12	11 - 8	7 - 4	3 - 0	
+2	7010	0111	0000	0001	0000	Command code
+3	0030	0000	0000	0011	0000	Response target command codes
+4	-	0000	0000	0000	0000	Response code
+5	-	0000	0000	0000	0000	Command execution result OK: 0 (0000 0000) NG: Not 0 (0000 0000)

Set Communications Output Status

Permits/prohibits outputs to external devices.

Command (PLC to Sensor Controller)

First word in Command Area	Hexadecimal notation	Bit				Description
		15 - 12	11 - 8	7 - 4	3 - 0	
+2	7020	0111	0000	0010	0000	Command code
+3	0030	0000	0000	0011	0000	
+4	-	0000	0000	0000	0000	Output state 0: Prohibited 1: Permitted
+5	-	0000	0000	0000	0000	

Response (Sensor Controller to PLC)

First word in Response Area	Hexadecimal notation	Bit				Description
		15 - 12	11 - 8	7 - 4	3 - 0	
+2	7020	0111	0000	0010	0000	Command code
+3	0030	0000	0000	0011	0000	Response target command codes
+4	-	0000	0000	0000	0000	Response code
+5	-	0000	0000	0000	0000	Command execution result OK: 0 (0000 0000) NG: Not 0 (0000 0000)

Set Parallel Terminal Status

Sets the ON/OFF status of the specified parallel I/O terminal.

Specifies the Parallel terminal with a combination of terminal type, terminal number, and terminal status.

For how to set, refer to the following example and the description in the table.

Example:

When you want to set the OR3 of Line3 status.

1. Select 6 in terminal type, *OR* is set.
2. Select 3 in terminal number, *OR3* is set.
3. Select 1 in terminal status, *OR3* terminal switches from OFF to ON.
4. Send the command set in the above step 1 to 3 to the port number of Line 3.
5. Executed results of the command is responded.

Command (PLC to Sensor Controller)

First word in Command Area	Hexadecimal notation	Bit				Description
		15 - 12	11 - 8	7 - 4	3 - 0	
+2	8010	1000	0000	0001	0000	Command code
+3	0030	0000	0000	0011	0000	
+4	-	0000	0000	0000	0000	Terminal type:
+5	-	0000	0000	0000	0000	Set the terminal by combining the Terminal number. Specified terminal differs according to the Sensor Controller series. For details, refer to *1.
+6	-	0000	0000	0000	0000	Terminal number:
+7	-	0000	0000	0000	0000	Set the terminal by combining the Terminal type. Specified terminal differs according to the Sensor Controller series. For details, refer to *1.
+8	-	0000	0000	0000	0000	Terminal status
+9	-	0000	0000	0000	0000	Set the specified terminal status. (0: OFF/1: ON)

Response (Sensor Controller to PLC)

First word in Response Area	Hexadecimal notation	Bit				Description
		15 - 12	11 - 8	7 - 4	3 - 0	
+2	8010	1000	0000	0001	0000	Command code
+3	0030	0000	0000	0011	0000	Response target command codes
+4	-	0000	0000	0000	0000	Response code
+5	-	0000	0000	0000	0000	Command execution result OK: 0 (0000 0000) NG: Not 0 (0000 0000)

*1. Terminal type and terminal number

FH-2000 / FH-5000 series Sensor Controller

Terminal type		Terminal number							
		0	1	2	3	4	5	6	7
RUN	3	RUN0	RUN1	RUN2	RUN3	-	-	-	-
ERR	4	ERROR/ ERROR0	ERROR1	ERROR2	ERROR3	-	-	-	-
BUSY	5	BUSY0	BUSY1	BUSY2	BUSY3	BUSY4	BUSY5	BUSY6	BUSY7
OR	6	OR0	OR1	OR2	OR3	OR4	OR5	OR6	OR7
GATE	7	GATE0	GATE1	-	-	-	-	-	-
READY	8	READY0	READY1	READY2	READY3	READY4	READY5	READY6	READY7
DO	9	DO0	DO1	DO2	DO3	DO4	DO5	DO6	DO7
ACK	10	ACK	-	-	-	-	-	-	-

Terminal type		Terminal number							
		8	9	10	11	12	13	14	15
RUN	3	-	-	-	-	-	-	-	-
ERR	4	-	-	-	-	-	-	-	-
BUSY	5	-	-	-	-	-	-	-	-
OR	6	-	-	-	-	-	-	-	-
GATE	7	-	-	-	-	-	-	-	-
READY	8	-	-	-	-	-	-	-	-
DO	9	DO8	DO9	DO10	DO11	DO12	DO13	DO14	DO15
ACK	10	-	-	-	-	-	-	-	-

FH-L / FHV series Sensor Controller

Terminal type		Terminal number							
		0	1	2	3	4	5	6	7
RUN	3	RUN	-	-	-	-	-	-	-
ERR	4	ERROR	-	-	-	-	-	-	-
BUSY	5	BUSY0	-	-	-	-	-	-	-
OR	6	OR0	-	-	-	-	-	-	-
GATE	7	GATE0	-	-	-	-	-	-	-
READY	8	READY0	-	-	-	-	-	-	-
DO	9	DO0	DO1	DO2	DO3	DO4	DO5	DO6	DO7

Terminal type		Terminal number							
		0	1	2	3	4	5	6	7
ACK	10	-	-	-	-	-	-	-	-

Terminal type		Terminal number								
		8	9	10	11	12	13	14	15	
RUN	3	-	-	-	-	-	-	-	-	-
ERR	4	-	-	-	-	-	-	-	-	-
BUSY	5	-	-	-	-	-	-	-	-	-
OR	6	-	-	-	-	-	-	-	-	-
GATE	7	-	-	-	-	-	-	-	-	-
READY	8	-	-	-	-	-	-	-	-	-
DO	9	DO8	DO9	DO10	DO11	DO12	DO13	DO14	DO15	
ACK	10	-	-	-	-	-	-	-	-	



Precautions for Correct Use

- When the Multi-line Random-trigger mode is selected in the following series, usable signal type or assignment are differ depending on the used number of Lines.
 - FH-2000 series
 - FH-5000 series
 For more details of Operation mode, refer to *Multi-line Random-trigger Mode Signal Specifications* on page 2-391.
- The terminal status of each line can be got by sending this command to the port number allocated to them. For signals that are common in all lines, the terminal status can be got from any line used.

When the terminal state of an unusable or a different line was set, the response code will be OK and the set terminal state will be discarded.

Check the status of the received data by changing the actual parallel terminal status.

Set All Parallel Terminal Status

Sets the ON/OFF status of all parallel terminals except for DO terminals.

For how to set, refer to the following example and the description in the table.

Example:

When you want to set the Parallel terminal status, except DO of Line 0, to ON at once:

- Set the terminal status ON to the desired assignment BIT of Parallel terminal except DO.
- Send the specified command set in the above step 1 to the port number of Line 0.
- Executed results of the command is responded.

Command (PLC to Sensor Controller)

First word in Command Area	Hexadecimal notation	Bit				Description
		15 - 12	11 - 8	7 - 4	3 - 0	
+2	8020	1000	0000	0010	0000	Command code
+3	0030	0000	0000	0011	0000	

First word in Command Area	Hexadecimal notation	Bit				Description
		15 - 12	11 - 8	7 - 4	3 - 0	
+4	-	0000	0000	0000	0000	Terminal status
+5	-	0000	0000	0000	0000	Set the terminal status (0: OFF/1: ON) to the assigned terminal of each BIT. For details of the assigned terminal, refer to *1.

Response (Sensor Controller to PLC)

First word in Response Area	Hexadecimal notation	Bit				Description
		15 - 12	11 - 8	7 - 4	3 - 0	
+2	8020	1000	0000	0010	0000	Command code
+3	0030	0000	0000	0011	0000	Response target command codes
+4	-	0000	0000	0000	0000	Response code
+5	-	0000	0000	0000	0000	Command execution result OK: 0 (0000 0000) NG: Not 0 (0000 0000)

*1. Assigned terminal to each bit

FH-2000 / FH-5000 series Sensor Controller

Support-ed bit	Terminal							
	Line 0	Line 1	Line 2	Line 3	Line 4	Line 5	Line 6	Line 7
BIT0	RUN0	RUN1	RUN2	RUN3	-	-	-	-
BIT1	ERROR/ ERROR0	ERROR1	ERROR2	ERROR3	ERROR	ERROR	ERROR	ERROR
BIT2	BUSY0	BUSY1	BUSY2	BUSY3	BUSY4	BUSY5	BUSY6	BUSY7
BIT3	OR0	OR1	OR2	OR3	OR4	OR5	OR6	OR7
BIT4	GATE0	GATE1	-	-	-	-	-	-
BIT5	READY0	READY1	READY2	READY3	READY4	READY5	READY6	READY7
BIT6	ACK	ACK	ACK	ACK	ACK	ACK	ACK	ACK
BIT7	-	-	-	-	-	-	-	-
BIT8	-	-	-	-	-	-	-	-
BIT9	-	-	-	-	-	-	-	-
BIT10	-	-	-	-	-	-	-	-
BIT11	-	-	-	-	-	-	-	-
BIT12	-	-	-	-	-	-	-	-
BIT13	-	-	-	-	-	-	-	-
BIT14	-	-	-	-	-	-	-	-
BIT15	-	-	-	-	-	-	-	-

FH-L series Sensor Controller

Support-ed bit	Terminal
	Line 0
BIT0	RUN
BIT1	ERROR

Support- ed bit	Terminal
	Line 0
BIT2	BUSY
BIT3	OR0
BIT4	GATE0
BIT5	READY0
BIT6	ACK
BIT7	-
BIT8	-
BIT9	-
BIT10	-
BIT11	-
BIT12	-
BIT13	-
BIT14	-
BIT15	-



Precautions for Correct Use

- When the Multi-line Random-trigger mode is selected in the following series, usable signal type or assignment are differ depending on the used number of Lines.
 - FH-2000 series
 - FH-5000 series
 For more details of Operation mode, refer to *Multi-line Random-trigger Mode Signal Specifications* on page 2-391.
- The terminal status of each line can be got by sending this command to the port number allocated to them. For signals that are common in all lines, the terminal status can be got from any line used.

When the terminal state of an unusable or a different line was set, the response code will be OK and the set terminal state will be discarded.

Check the status of the received data by changing the actual parallel terminal status.

Set All Parallel DO Terminal Status

Sets the ON/OFF status of all parallel DO terminals.

For how to set, refer to the following example and the description in the table.

Example)

When you want to set the Parallel DO terminals status of Line 0, to ON at once:

- Set the terminals status ON to the desired assignment BIT of the Parallel DO terminal status.
- Send the specified command set in the above step 1 to the port number of Line 0.
- Executed results of the command is responded.

Command (PLC to Sensor Controller)

First word in Command Area	Hexadecimal notation	Bit				Description
		15 - 12	11 - 8	7 - 4	3 - 0	
+2	8030	1000	0000	0011	0000	Command code
+3	0030	0000	0000	0011	0000	

First word in Command Area	Hexadecimal notation	Bit				Description
		15 - 12	11 - 8	7 - 4	3 - 0	
+4	-	0000	0000	0000	0000	Terminal status
+5	-	0000	0000	0000	0000	The Parallel terminal state (0: OFF / 1: ON) is assigned to BIT of the Terminal status. This assignment differs by the Sensor Controller series or by line in use. For more details, refer to *1.

Response (Sensor Controller to PLC)

First word in Response Area	Hexadecimal notation	Bit				Description
		15 - 12	11 - 8	7 - 4	3 - 0	
+2	8030	1000	0000	0011	0000	Command code
+3	0030	0000	0000	0011	0000	Response target command codes
+4	-	0000	0000	0000	0000	Response code
+5	-	0000	0000	0000	0000	Command execution result OK: 0 (0000 0000) NG: Not 0 (0000 0000)

*1. Assigned terminal to each bit

FH-2000 / FH-5000 series Sensor Controller

Support- ed bit	Terminal							
	Line 0	Line 1	Line 2	Line 3	Line 4	Line 5	Line 6	Line 7
BIT0	DO0	DO0	DO0	DO0	DO0	DO0	DO0	DO0
BIT1	DO1	DO1	DO1	DO1	DO1	DO1	DO1	DO1
BIT2	DO2	DO2	DO2	DO2	DO2	DO2	DO2	DO2
BIT3	DO3	DO3	DO3	DO3	DO3	DO3	DO3	DO3
BIT4	DO4	DO4	DO4	DO4	DO4	DO4	DO4	DO4
BIT5	DO5	DO5	DO5	DO5	DO5	DO5	DO5	DO5
BIT6	DO6	DO6	DO6	DO6	DO6	DO6	DO6	DO6
BIT7	DO7	DO7	DO7	DO7	DO7	DO7	DO7	DO7
BIT8	DO8	DO8	DO8	DO8	DO8	DO8	DO8	DO8
BIT9	DO9	DO9	DO9	DO9	DO9	DO9	DO9	DO9
BIT10	DO10	DO10	DO10	DO10	DO10	DO10	DO10	DO10
BIT11	DO11	DO11	DO11	DO11	DO11	DO11	DO11	DO11
BIT12	DO12	DO12	DO12	DO12	DO12	DO12	DO12	DO12
BIT13	DO13	DO13	DO13	DO13	DO13	DO13	DO13	DO13
BIT14	DO14	DO14	DO14	DO14	DO14	DO14	DO14	DO14
BIT15	DO15	DO15	DO15	DO15	DO15	DO15	DO15	DO15

FH-L series Sensor Controller

Support- ed bit	Terminal
	Line 0
BIT0	DO0

Support- ed bit	Terminal
	Line 0
BIT1	DO1
BIT2	DO2
BIT3	DO3
BIT4	DO4
BIT5	DO5
BIT6	DO6
BIT7	DO7
BIT8	DO8
BIT9	DO9
BIT10	DO10
BIT11	DO11
BIT12	DO12
BIT13	DO13
BIT14	DO14
BIT15	DO15



Precautions for Correct Use

This command sets the terminal state of each line by specifying its port number. When the terminal state of an unusable or a different line was set, the response code will be OK and the set terminal state will be discarded. Check the status of the received data by changing the actual parallel terminal status.

Switch Login Account

Switches the currently logged in account.

Command (PLC to Sensor Controller)

First word in Command Area	Hexadecimal notation	Bit				Description
		15 - 12	11 - 8	7 - 4	3 - 0	
+2	9000	1001	0000	0000	0000	Command code
+3	0030	0000	0000	0011	0000	
+4	-	0000	0000	0000	0000	Item to be got 0: Local 1: Remote
+5	-	0000	0000	0000	0000	
+6	-	0000	0000	0000	0000	User name of user account
:	-	0000	0000	0000	0000	
+13	-	0000	0000	0000	0000	
+14	-	0000	0000	0000	0000	Password
:	-	0000	0000	0000	0000	
+21	-	0000	0000	0000	0000	

Response (Sensor Controller to PLC)

First word in Response Area	Hexadecimal notation	Bit				Description
		15 - 12	11 - 8	7 - 4	3 - 0	
+2	9000	1001	0000	0000	0000	Command code
+3	0030	0000	0000	0011	0000	Response target command codes
+4	-	0000	0000	0000	0000	Response code
+5	-	0000	0000	0000	0000	Command execution result OK: 0 (0000 0000) NG: Not 0 (0000 0000)

Set Operation Log State

Sets the state of the operation log.

This command allows configuring the logging operation state in the same manner as for the Start/End Logging Operation buttons on the Main screen.

Command (PLC to Sensor Controller)

First word in Command Area	Hexadecimal notation	Bit				Description
		15 - 12	11 - 8	7 - 4	3 - 0	
+2	a000	1010	0000	0000	0000	Command code
+3	0030	0000	0000	0011	0000	
+4	-	0000	0000	0000	0000	Logging operation state
+5	-	0000	0000	0000	0000	0: OFF 1: ON

Response (Sensor Controller to PLC)

First word in Response Area	Hexadecimal notation	Bit				Description
		15 - 12	11 - 8	7 - 4	3 - 0	
+2	a000	1010	0000	0000	0000	Command code
+3	0030	0000	0000	0011	0000	Response target command codes
+4	-	0000	0000	0000	0000	Response code
+5	-	0000	0000	0000	0000	Command execution result OK: 0 (0000 0000) NG: Not 0 (0000 0000)

Get Unit Data

Gets the specified processing unit data.



Precautions for Correct Use

- You can set or get only numeric data in processing unit data.
- Character string data such as comparison strings for general-purpose character tests, judgment comparison strings for bar codes or 2D codes, or OCR target strings cannot be set or got.

Command (PLC to Sensor Controller)

First word in Command Area	Hexadecimal notation	Bit				Description
		15 - 12	11 - 8	7 - 4	3 - 0	
+2	1000	0001	0000	0000	0000	Command code
+3	0040	0000	0000	0010	0000	
+4	-	0000	0000	0000	0000	Unit No.
+5	-	0000	0000	0000	0000	
+6	-	0000	0000	0000	0000	Data number in the External Reference Tables.
+7	-	0000	0000	0000	0000	

Response (Sensor Controller to PLC)

First word in Response Area	Hexadecimal notation	Bit				Description
		15 - 12	11 - 8	7 - 4	3 - 0	
+2	1000	0001	0000	0000	0000	Command code
+3	0040	0000	0000	0010	0000	Response target command codes
+4	-	0000	0000	0000	0000	Response code
+5	-	0000	0000	0000	0000	Command execution result OK: 0 (0000 0000) NG: Not 0 (0000 0000)
+6	-	0000	0000	0000	0000	Got data
+7	-	0000	0000	0000	0000	(Value multiplied by 1000)

Get Date and Time

Gets the date and time.

Command (PLC to Sensor Controller)

First word in Command Area	Hexadecimal notation	Bit				Description
		15 - 12	11 - 8	7 - 4	3 - 0	
+2	2000	0010	0000	0000	0000	Command code
+3	0040	0000	0000	0100	0000	

Response (Sensor Controller to PLC)

First word in Response Area	Hexadecimal notation	Bit				Description
		15 - 12	11 - 8	7 - 4	3 - 0	
+2	2000	0010	0000	0000	0000	Command code
+3	0040	0000	0000	0100	0000	Response target command codes
+4	-	0000	0000	0000	0000	Response code
+5	-	0000	0000	0000	0000	Command execution result OK: 0 (0000 0000) NG: Not 0 (0000 0000)
+6	-	0000	0000	0000	0000	Year data: 1900 to 2100
+7	-	0000	0000	0000	0000	Month data: 1 to 12
+8	-	0000	0000	0000	0000	
+9	-	0000	0000	0000	0000	
+10	-	0000	0000	0000	0000	Date data: 1 to 31
+11	-	0000	0000	0000	0000	Hour data: 0 to 23
+12	-	0000	0000	0000	0000	
+13	-	0000	0000	0000	0000	
+14	-	0000	0000	0000	0000	Minute data: 0 to 59
+15	-	0000	0000	0000	0000	Second data: 0 to 59
+16	-	0000	0000	0000	0000	
+17	-	0000	0000	0000	0000	

Get Version Information

Gets the Sensor Controller version information.

Command (PLC to Sensor Controller)

First word in Command Area	Hexadecimal notation	Bit				Description
		15 - 12	11 - 8	7 - 4	3 - 0	
+2	3000	0011	0000	0000	0000	Command code
+3	0040	0000	0000	0100	0000	

Response (Sensor Controller to PLC)

First word in Response Area	Hexadecimal notation	Bit				Description
		15 - 12	11 - 8	7 - 4	3 - 0	
+2	3000	0011	0000	0000	0000	Command code
+3	0040	0000	0000	0100	0000	Response target command codes
+4	-	0000	0000	0000	0000	Response code
+5	-	0000	0000	0000	0000	Command execution result OK: 0 (0000 0000) NG: Not 0 (0000 0000)

First word in Response Area	Hexadecimal notation	Bit				Description
		15 - 12	11 - 8	7 - 4	3 - 0	
+6	-	0000	0000	0000	0000	Response data Version information character string
+7	-	0000	0000	0000	0000	
+8	-	0000	0000	0000	0000	
+9	-	0000	0000	0000	0000	
:	-	0000	0000	0000	0000	
:	-	0000	0000	0000	0000	

Get Settings Related to Image Logging

Gets settings related to image logging.

Command (PLC to Sensor Controller)

First word in Command Area	Hexadecimal notation	Bit				Description
		15 - 12	11 - 8	7 - 4	3 - 0	
+2	4000	0100	0000	0000	0000	Command code
+3	0040	0000	0000	0100	0000	
+4	-	0000	0000	0000	0000	[Identifier 0] [Identifier 1]
+5	-	0000	0000	0000	0000	[Identifier 0]: Logging
+6	-	0000	0000	0000	0000	[Identifier 1]: Identifier of setting to get
+7	-	0000	0000	0000	0000	<ul style="list-style-type: none"> imageLogging (image logging)
:	-	0000	0000	0000	0000	<ul style="list-style-type: none"> imageLoggingDirectory (image log saving destination folder name of <i>Save to memory + file</i>) imageLoggingHeader (prefix of image log filename) dataLogging (data logging) dataLoggingDirectory (data log saving destination folder name)
:	-	0000	0000	0000	0000	

Response (Sensor Controller to PLC)

First word in Response Area	Hexadecimal notation	Bit				Description
		15 - 12	11 - 8	7 - 4	3 - 0	
+2	4000	0100	0000	0000	0000	Command code
+3	0040	0000	0000	0100	0000	Response target command codes
+4	-	0000	0000	0000	0000	Response code
+5	-	0000	0000	0000	0000	Command execution result OK: 0 (0000 0000) NG: Not 0 (0000 0000)

First word in Response Area	Hexadecimal notation	Bit				Description
		15 - 12	11 - 8	7 - 4	3 - 0	
+6	-	0000	0000	0000	0000	[Identifier 0] [Identifier 1]
+7	-	0000	0000	0000	0000	[Identifier 0]: Logging
+8	-	0000	0000	0000	0000	[Identifier 1]: Identifier of setting to get
+9	-	0000	0000	0000	0000	<ul style="list-style-type: none"> For imageLogging (image log): 0 (will not save), 1 (save when NG), 2 (save all) For imageLoggingDirectory (image log saving destination folder name of <i>Save to memory + file</i>): Destination folder name (half-width alphanumeric) For imageLoggingHeader (prefix of image logfile name): Prefix of image log file name (halfwidth alphanumeric) For dataLogging (data logging): 0 (will not save), 1 (save when NG), 2 (save all) For dataLoggingDirectory: saving destination folder name (half-width alphanumeric)
:	-	0000	0000	0000	0000	
:	-	0000	0000	0000	0000	
:	-	0000	0000	0000	0000	

*1. Regarding the storage destination folder

The storage destination folder differ according to the Sensor Controller series.

- FH series/FHV series

RAM disk: C:\Data\RAMDisk

External storage device: E:\, F:\, G:\, H:\, M:\, S:\, T:\, U:\, V:\, W:\, X:\, Y:\, Z:\

- Do not save to any folder except RAMDisk and external storage device (such as C:\ProgramFiles\FZ).

It is possible not to perform correctly due to the decrease of Scene data storage region.

Get Image Logging Folder Name

Gets the image logging folder name.

Command (PLC to Sensor Controller)

First word in Command Area	Hexadecimal notation	Bit				Description
		15 - 12	11 - 8	7 - 4	3 - 0	
+2	4010	0100	0000	0001	0000	Command code
+3	0040	0000	0000	0100	0000	

Response (Sensor Controller to PLC)

First word in Response Area	Hexadecimal notation	Bit				Description
		15 - 12	11 - 8	7 - 4	3 - 0	
+2	4010	0011	0000	0000	0000	Command code
+3	0040	0000	0000	0111	0000	Response target command codes
+4	-	0000	0000	0000	0000	Response code
+5	-	0000	0000	0000	0000	Command execution result OK: 0 (0000 0000) NG: Not 0 (0000 0000)
+6	-	0000	0000	0000	0000	Response data
+7	-	0000	0000	0000	0000	Folder name (absolute path)
:	-	0000	0000	0000	0000	

Get Data Logging Folder Name

Gets the data logging folder name.

Command (PLC to Sensor Controller)

First word in Command Area	Hexadecimal notation	Bit				Description
		15 - 12	11 - 8	7 - 4	3 - 0	
+2	4020	0100	0000	0010	0000	Command code
+3	0040	0000	0000	0100	0000	

Response (Sensor Controller to PLC)

First word in Response Area	Hexadecimal notation	Bit				Description
		15 - 12	11 - 8	7 - 4	3 - 0	
+2	4020	0100	0000	0010	0000	Command code
+3	0040	0000	0000	0100	0000	Response target command codes
+4	-	0000	0000	0000	0000	Response code
+5	-	0000	0000	0000	0000	Command execution result OK: 0 (0000 0000) NG: Not 0 (0000 0000)
+6	-	0000	0000	0000	0000	Response data
+7	-	0000	0000	0000	0000	Folder name (absolute path)
:	-	0000	0000	0000	0000	

Get Screen Capture Folder Name

Gets the screen capture folder name.

Command (PLC to Sensor Controller)

First word in Command Area	Hexadecimal notation	Bit				Description
		15 - 12	11 - 8	7 - 4	3 - 0	
+2	4030	0100	0000	0011	0000	Command code
+3	0040	0000	0000	0100	0000	

Response (Sensor Controller to PLC)

First word in Response Area	Hexadecimal notation	Bit				Description
		15 - 12	11 - 8	7 - 4	3 - 0	
+2	4030	0100	0000	0011	0000	Command code
+3	0040	0000	0000	0100	0000	Response target command codes
+4	-	0000	0000	0000	0000	Response code
+5	-	0000	0000	0000	0000	Command execution result OK: 0 (0000 0000) NG: Not 0 (0000 0000)
+6	-	0000	0000	0000	0000	Response data
+7	-	0000	0000	0000	0000	Folder name (absolute path)
:	-	0000	0000	0000	0000	

Get Image Logging Prefix

Gets the prefix for the file name in which logged images are saved.

Command (PLC to Sensor Controller)

First word in Command Area	Hexadecimal notation	Bit				Description
		15 - 12	11 - 8	7 - 4	3 - 0	
+2	4040	0100	0000	0100	0000	Command code
+3	0040	0000	0000	0100	0000	

Response (Sensor Controller to PLC)

First word in Response Area	Hexadecimal notation	Bit				Description
		15 - 12	11 - 8	7 - 4	3 - 0	
+2	4040	0100	0000	0100	0000	Command code
+3	0040	0000	0000	0100	0000	Response target command codes

First word in Response Area	Hexadecimal notation	Bit				Description
		15 - 12	11 - 8	7 - 4	3 - 0	
+4	-	0000	0000	0000	0000	Response code Command execution result OK: 0 (0000 0000) NG: Not 0 (0000 0000)
+5	-	0000	0000	0000	0000	
+6	-	0000	0000	0000	0000	Response data Image logging prefix character string
+7	-	0000	0000	0000	0000	
:	-	0000	0000	0000	0000	

Get Data Logging Conditions

Gets the conditions set for data logging.

Command (PLC to Sensor Controller)

First word in Command Area	Hexadecimal notation	Bit				Description
		15 - 12	11 - 8	7 - 4	3 - 0	
+2	4050	0100	0000	0101	0000	Command code
+3	0040	0000	0000	0100	0000	

Response (Sensor Controller to PLC)

First word in Response Area	Hexadecimal notation	Bit				Description
		15 - 12	11 - 8	7 - 4	3 - 0	
+2	4050	0100	0000	0101	0000	Command code Response target command codes
+3	0040	0000	0000	0100	0000	
+4	-	0000	0000	0000	0000	Response code Command execution result OK: 0 (0000 0000) NG: Not 0 (0000 0000)
+5	-	0000	0000	0000	0000	
+6	-	0000	0000	0000	0000	Response data Data logging condition gotten 0: None 1: Only NG 2: All
+7	-	0000	0000	0000	0000	

Get Parallel Terminal Offset

Gets the parallel DI terminal offset data that is set.

The parallel DI terminal offset is the value that is added to the DI0-DI4 command parameter when a parallel command is executed.

This command is only performed properly after the offset value was set using Set Parallel Terminal Offset command.

Command (PLC to Sensor Controller)

First word in Command Area	Hexadecimal notation	Bit				Description
		15 - 12	11 - 8	7 - 4	3 - 0	
+2	4060	0100	0000	0110	0000	Command code
+3	0040	0000	0000	0100	0000	

Response (Sensor Controller to PLC)

First word in Response Area	Hexadecimal notation	Bit				Description
		15 - 12	11 - 8	7 - 4	3 - 0	
+2	4060	0100	0000	0110	0000	Command code
+3	0040	0000	0000	0100	0000	Response target command codes
+4	-	0000	0000	0000	0000	Response code
+5	-	0000	0000	0000	0000	Command execution result OK: 0 (0000 0000) NG: Not 0 (0000 0000)
+6	-	0000	0000	0000	0000	Response data
+7	-	0000	0000	0000	0000	got parallel DI terminal offset value 0 to 9999

Set Unit Data

Sets the specified unit data.



Precautions for Correct Use

- You can set or get only numeric data in processing unit data.
- Character string data such as comparison strings for general-purpose character tests, judgment comparison strings for bar codes or 2D codes, or OCR target strings cannot be set or got.

Command (PLC to Sensor Controller)

First word in Command Area	Hexadecimal notation	Bit				Description
		15 - 12	11 - 8	7 - 4	3 - 0	
+2	1000	0001	0000	0000	0000	Command code
+3	0050	0000	0000	0101	0000	
+4	0000	0000	0000	0000	0000	Unit No.
+5	0000	0000	0000	0000	0000	Data number in the External Reference Tables.
+6	0000	0000	0000	0000	0000	
+7	0000	0000	0000	0000	0000	Data to be set (Value multiplied by 1000)
+8	0000	0000	0000	0000	0000	
+9	0000	0000	0000	0000	0000	

Response (Sensor Controller to PLC)

First word in Response Area	Hexadecimal notation	Bit				Description
		15 - 12	11 - 8	7 - 4	3 - 0	
+2	1000	0001	0000	0000	0000	Command code Response target command codes
+3	0050	0000	0000	0101	0000	
+4	0000	0000	0000	0000	0000	Response code Command execution result OK: 0 (0000 0000) NG: Not 0 (0000 0000)
+5	0000	0000	0000	0000	0000	

Set Date and Time

Sets the date and time.

Command (PLC to Sensor Controller)

First word in Command Area	Hexadecimal notation	Bit				Description
		15 - 12	11 - 8	7 - 4	3 - 0	
+2	2000	0010	0000	0000	0000	Command code
+3	0050	0000	0000	0101	0000	
+4	0000	0000	0000	0000	0000	Year data: 1900 to 2100
+5	0000	0000	0000	0000	0000	
+6	0000	0000	0000	0000	0000	Month data: 1 to 12
+7	0000	0000	0000	0000	0000	
+8	0000	0000	0000	0000	0000	Date data: 1 to 31
+9	0000	0000	0000	0000	0000	
+10	0000	0000	0000	0000	0000	Hour data: 0 to 23
+11	0000	0000	0000	0000	0000	
+12	0000	0000	0000	0000	0000	Minute data: 0 to 59
+13	0000	0000	0000	0000	0000	
+14	0000	0000	0000	0000	0000	Second data: 0 to 59
+15	0000	0000	0000	0000	0000	

Response (Sensor Controller to PLC)

First word in Response Area	Hexadecimal notation	Bit				Description
		15 - 12	11 - 8	7 - 4	3 - 0	
+2	2000	0010	0000	0000	0000	Command code Response target command codes
+3	0050	0000	0000	0101	0000	
+4	0000	0000	0000	0000	0000	Response code Command execution result OK: 0 (0000 0000) NG: Not 0 (0000 0000)
+5	0000	0000	0000	0000	0000	

Change Settings Related to Image Logging

Changes the settings related to image logging.

Command (PLC to Sensor Controller)

First word in Command Area	Hexadecimal notation	Bit				Description
		15 - 12	11 - 8	7 - 4	3 - 0	
+2	4000	0100	0000	0000	0000	Command code
+3	0050	0000	0000	0101	0000	
+4	0000	0000	0000	0000	0000	[Identifier 0] [Identifier 1] [Set value]
+5	0000	0000	0000	0000	0000	[Identifier 0]: Logging
+6	0000	0000	0000	0000	0000	[Identifier 1]: Identifier of settings data to set and set value.
+7	0000	0000	0000	0000	0000	Separate the setting name and set value with 00 (NULL).
:	0000	0000	0000	0000	0000	<ul style="list-style-type: none"> imageLogging + 0 (do not save)/1 (save only NG)/2 (save all) imageLoggingDirectory (image logging folder name of <i>Save to memory + file</i>) + folder_name^{*1*2} (single-byte alphanumeric characters) imageLoggingHeader + Prefix_for_image_logging_file_name (singlebyte alphanumeric characters) DataLogging + 0 (do not save)/1 (save only NG)/2 (save all) dataLoggingDirectory (data logging folder name) + folder_name (single-byte alphanumeric characters)
:	0000	0000	0000	0000	0000	

*1. If the name of a folder that does not exist is specified, a new folder will be created.

*2. Regarding the storage destination folder

The storage destination folder differ according to the Sensor Controller series.

- FH series/FHV series

RAM disk: C:\Data\RAMDisk

External storage device: E:\, F:\, G:\, H:\, M:\, S:\, T:\, U:\, V:\, W:\, X:\, Y:\, Z:\

- Do not save to any folder except RAMDisk and external storage device (such as C:\ProgramFiles\FZ).

It is possible not to perform correctly due to the decrease of Scene data storage region.

Response (Sensor Controller to PLC)

First word in Response Area	Hexadecimal notation	Bit				Description
		15 - 12	11 - 8	7 - 4	3 - 0	
+2	4000	0100	0000	0000	0000	Command code
+3	0050	0000	0000	0101	0000	Response target command codes
+4	0000	0000	0000	0000	0000	Response code
+5	0000	0000	0000	0000	0000	Command execution result OK: 0 (0000 0000) NG: Not 0 (0000 0000)

Set Image Logging Folder Name

Sets the name for the image logging folder.

Command (PLC to Sensor Controller)

First word in Command Area	Hexadecimal notation	Bit				Description
		15 - 12	11 - 8	7 - 4	3 - 0	
+2	4010	0100	0000	0001	0000	Command code
+3	0050	0000	0000	0101	0000	
+4	-	0000	0000	0000	0000	Name of the image capture folder with the absolute path
+5	-	0000	0000	0000	0000	Up to 230 characters
:	-	0000	0000	0000	0000	

Response (Sensor Controller to PLC)

First word in Response Area	Hexadecimal notation	Bit				Description
		15 - 12	11 - 8	7 - 4	3 - 0	
+2	4010	0100	0000	0001	0000	Command code
+3	0050	0000	0000	0101	0000	Response target command codes
+4	-	0000	0000	0000	0000	Response code
+5	-	0000	0000	0000	0000	Command execution result OK: 0 (0000 0000) NG: Not 0 (0000 0000)

Set Data Logging Folder Name

Sets the name for the data logging folder.

Command (PLC to Sensor Controller)

First word in Command Area	Hexadecimal notation	Bit				Description
		15 - 12	11 - 8	7 - 4	3 - 0	
+2	4020	0100	0000	0010	0000	Command code
+3	0050	0000	0000	0101	0000	
+4	-	0000	0000	0000	0000	Name of the data logging folder with the absolute path. Up to 247 characters
+5	-	0000	0000	0000	0000	
:	-	0000	0000	0000	0000	

Response (Sensor Controller to PLC)

First word in Response Area	Hexadecimal notation	Bit				Description
		15 - 12	11 - 8	7 - 4	3 - 0	
+2	4020	0100	0000	0010	0000	Command code
+3	0050	0000	0000	0101	0000	Response target command codes
+4	-	0000	0000	0000	0000	Response code
+5	-	0000	0000	0000	0000	Command execution result OK: 0 (0000 0000) NG: Not 0 (0000 0000)

Set Screen Capture Folder Name

Sets the name for the screen capture folder.

Command (PLC to Sensor Controller)

First word in Command Area	Hexadecimal notation	Bit				Description
		15 - 12	11 - 8	7 - 4	3 - 0	
+2	4030	0100	0000	0011	0000	Command code
+3	0050	0000	0000	0101	0000	
+4	-	0000	0000	0000	0000	Name of the image capture folder with the absolute path. Up to 227 characters
+5	-	0000	0000	0000	0000	
:	-	0000	0000	0000	0000	

Response (Sensor Controller to PLC)

First word in Response Area	Hexadecimal notation	Bit				Description
		15 - 12	11 - 8	7 - 4	3 - 0	
+2	4030	0100	0000	0011	0000	Command code
+3	0050	0000	0000	0101	0000	Response target command codes

First word in Response Area	Hexadecimal notation	Bit				Description
		15 - 12	11 - 8	7 - 4	3 - 0	
+4	-	0000	0000	0000	0000	Response code Command execution result OK: 0 (0000 0000) NG: Not 0 (0000 0000)
+5	-	0000	0000	0000	0000	

Set Image Logging Prefix

Sets the prefix for the file name in which logged images are saved.

Command (PLC to Sensor Controller)

First word in Command Area	Hexadecimal notation	Bit				Description
		15 - 12	11 - 8	7 - 4	3 - 0	
+2	4040	0100	0000	0100	0000	Command code
+3	0050	0000	0000	0101	0000	
+4	-	0000	0000	0000	0000	Image logging prefix Up to 32 characters
+5	-	0000	0000	0000	0000	
:	-	0000	0000	0000	0000	

Response (Sensor Controller to PLC)

First word in Response Area	Hexadecimal notation	Bit				Description
		15 - 12	11 - 8	7 - 4	3 - 0	
+2	4040	0100	0000	0100	0000	Command code
+3	0050	0000	0000	0101	0000	Response target command codes
+4	-	0000	0000	0000	0000	Response code
+5	-	0000	0000	0000	0000	Command execution result OK: 0 (0000 0000) NG: Not 0 (0000 0000)

Set Data Logging Conditions

Sets the data logging conditions.

Command (PLC to Sensor Controller)

First word in Command Area	Hexadecimal notation	Bit				Description
		15 - 12	11 - 8	7 - 4	3 - 0	
+2	4050	0100	0000	0101	0000	Command code
+3	0050	0000	0000	0101	0000	

First word in Command Area	Hexadecimal notation	Bit				Description
		15 - 12	11 - 8	7 - 4	3 - 0	
+4	-	0000	0000	0000	0000	Data logging condition 0: None 1: Only NG 2: All
+5	-	0000	0000	0000	0000	
:	-	0000	0000	0000	0000	

Response (Sensor Controller to PLC)

First word in Response Area	Hexadecimal notation	Bit				Description
		15 - 12	11 - 8	7 - 4	3 - 0	
+2	4050	0100	0000	0101	0000	Command code
+3	0050	0000	0000	0101	0000	Response target command codes
+4	-	0000	0000	0000	0000	Response code
+5	-	0000	0000	0000	0000	Command execution result OK: 0 (0000 0000) NG: Not 0 (0000 0000)

Set Parallel Terminal Offset

Sets the parallel DI terminal offset data.

The parallel DI terminal offset is the value that is added from the DI0 to DI4 command parameter when a parallel command is executed.

This is useful in the following cases.

Example:

This example is for creating a custom communications command for parallel communications that sets a numeric value using from DI0 to DI6.

- Without an Offset:
You can set only values between the minimum value of 0 and the maximum value of 127 (0111 1111 binary).
- With an Offset:
Adding an offset of 100 allows you to specify numeric values from a minimum value of 100 to a maximum value of 227 (127 + 100) by specifying the same values as those used without offsets.

Command (PLC to Sensor Controller)

First word in Command Area	Hexadecimal notation	Bit				Description
		15 - 12	11 - 8	7 - 4	3 - 0	
+2	4060	0100	0000	0110	0000	Command code
+3	0050	0000	0000	0101	0000	
+4	-	0000	0000	0000	0000	Parallel DI terminal offset data 0 to 9999
+5	-	0000	0000	0000	0000	

Response (Sensor Controller to PLC)

First word in Response Area	Hexadecimal notation	Bit				Description
		15 - 12	11 - 8	7 - 4	3 - 0	
+2	4060	0100	0000	0110	0000	Command code Response target command codes
+3	0050	0000	0000	0101	0000	
+4	-	0000	0000	0000	0000	Response code Command execution result OK: 0 (0000 0000) NG: Not 0 (0000 0000)
+5	-	0000	0000	0000	0000	

Load Scene Data

Loads the scene data.

Command (PLC to Sensor Controller)

First word in Command Area	Hexadecimal notation	Bit				Description
		15 - 12	11 - 8	7 - 4	3 - 0	
+2	1000	0001	0000	0000	0000	Command code
+3	0060	0000	0000	0110	0000	
+4	-	0000	0000	0000	0000	Number of scene to read
+5	-	0000	0000	0000	0000	
+6	-	0000	0000	0000	0000	Name of the file to be read with the absolute path. Up to 256 characters
+7	-	0000	0000	0000	0000	
:	-	0000	0000	0000	0000	

Response (Sensor Controller to PLC)

First word in Response Area	Hexadecimal notation	Bit				Description
		15 - 12	11 - 8	7 - 4	3 - 0	
+2	1000	0001	0000	0000	0000	Command code Response target command codes
+3	0060	0000	0000	0110	0000	
+4	-	0000	0000	0000	0000	Response code Command execution result OK: 0 (0000 0000) NG: Not 0 (0000 0000)
+5	-	0000	0000	0000	0000	

Load Scene Group Data

Loads the scene group data.

Command (PLC to Sensor Controller)

First word in Command Area	Hexadecimal notation	Bit				Description
		15 - 12	11 - 8	7 - 4	3 - 0	
+2	2000	0010	0000	0000	0000	Command code
+3	0060	0000	0000	0110	0000	
+4	-	0000	0000	0000	0000	Number of scene group to read
+5	-	0000	0000	0000	0000	
+6	-	0000	0000	0000	0000	Name of the file to be read with the absolute path.
+7	-	0000	0000	0000	0000	
:	-	0000	0000	0000	0000	Up to 256 characters

Response (Sensor Controller to PLC)

First word in Response Area	Hexadecimal notation	Bit				Description
		15 - 12	11 - 8	7 - 4	3 - 0	
+2	2000	0010	0000	0000	0000	Command code
+3	0060	0000	0000	0110	0000	Response target command codes
+4	-	0000	0000	0000	0000	Response code
+5	-	0000	0000	0000	0000	Command execution result OK: 0 (0000 0000) NG: Not 0 (0000 0000)

Load System Data

Loads the system data.

Command (PLC to Sensor Controller)

First word in Command Area	Hexadecimal notation	Bit				Description
		15 - 12	11 - 8	7 - 4	3 - 0	
+2	3000	0011	0000	0000	0000	Command code
+3	0060	0000	0000	0110	0000	
+4	-	0000	0000	0000	0000	Name of the file to be read with the absolute path.
+5	-	0000	0000	0000	0000	
:	-	0000	0000	0000	0000	Up to 256 characters

Response (Sensor Controller to PLC)

First word in Response Area	Hexadecimal notation	Bit				Description
		15 - 12	11 - 8	7 - 4	3 - 0	
+2	3000	0011	0000	0000	0000	Command code Response target command codes
+3	0060	0000	0000	0110	0000	
+4	-	0000	0000	0000	0000	Response code Command execution result OK: 0 (0000 0000) NG: Not 0 (0000 0000)
+5	-	0000	0000	0000	0000	

Load All Data

Loads the system + scene group 0 data.



Precautions for Correct Use

With this command, be sure to restart the Sensor Controller after reading the system + scene group 0 data to enable the data that was read.

Command (PLC to Sensor Controller)

First word in Command Area	Hexadecimal notation	Bit				Description
		15 - 12	11 - 8	7 - 4	3 - 0	
+2	5000	0101	0000	0000	0000	Command code
+3	0060	0000	0000	0110	0000	
+4	-	0000	0000	0000	0000	Name of the file to be read with the absolute path. Up to 256 characters
+5	-	0000	0000	0000	0000	
:	-	0000	0000	0000	0000	

Response (Sensor Controller to PLC)

First word in Response Area	Hexadecimal notation	Bit				Description
		15 - 12	11 - 8	7 - 4	3 - 0	
+2	5000	0101	0000	0000	0000	Command code Response target command codes
+3	0060	0000	0000	0110	0000	
+4	-	0000	0000	0000	0000	Response code Command execution result OK: 0 (0000 0000) NG: Not 0 (0000 0000)
+5	-	0000	0000	0000	0000	

Save Scene Data

Saves the scene data.

Command (PLC to Sensor Controller)

First word in Command Area	Hexadecimal notation	Bit				Description
		15 - 12	11 - 8	7 - 4	3 - 0	
+2	1000	0001	0000	0000	0000	Command code
+3	0070	0000	0000	0111	0000	
+4	-	0000	0000	0000	0000	Scene No. to save
+5	-	0000	0000	0000	0000	
+6	-	0000	0000	0000	0000	[Absolute path of save destination and save filename] Up to 256 characters
+7	-	0000	0000	0000	0000	
:	-	0000	0000	0000	0000	
+135	-	0000	0000	0000	0000	

Response (Sensor Controller to PLC)

First word in Response Area	Hexadecimal notation	Bit				Description
		15 - 12	11 - 8	7 - 4	3 - 0	
+2	1000	0001	0000	0000	0000	Command code
+3	0070	0000	0000	0111	0000	Response target command codes
+4	-	0000	0000	0000	0000	Response code
+5	-	0000	0000	0000	0000	Command execution result OK: 0 (0000 0000) NG: Not 0 (0000 0000)

Save Scene Group Data

Saves the scene group data.

Command (PLC to Sensor Controller)

First word in Command Area	Hexadecimal notation	Bit				Description
		15 - 12	11 - 8	7 - 4	3 - 0	
+2	2000	0010	0000	0000	0000	Command code
+3	0070	0000	0000	0111	0000	
+4	-	0000	0000	0000	0000	Scene group No. to save
+5	-	0000	0000	0000	0000	
+6	-	0000	0000	0000	0000	[Absolute path of save destination and save filename] Up to 256 characters
+7	-	0000	0000	0000	0000	
:	-	0000	0000	0000	0000	
		0000	0000	0000	0000	

Response (Sensor Controller to PLC)

First word in Response Area	Hexadecimal notation	Bit				Description
		15 - 12	11 - 8	7 - 4	3 - 0	
+2	2000	0010	0000	0000	0000	Command code
+3	0070	0000	0000	0111	0000	Response target command codes
+4	-	0000	0000	0000	0000	Response code
+5	-	0000	0000	0000	0000	Command execution result OK: 0 (0000 0000) NG: Not 0 (0000 0000)

Save System Data

Saves the system data.

Command (PLC to Sensor Controller)

First word in Command Area	Hexadecimal notation	Bit				Description
		15 - 12	11 - 8	7 - 4	3 - 0	
+2	3000	0011	0000	0000	0000	Command code
+3	0070	0000	0000	0111	0000	
+4	-	0000	0000	0000	0000	[Absolute path of save destination and save filename]
+5	-	0000	0000	0000	0000	Up to 256 characters
:	-	0000	0000	0000	0000	

Response (Sensor Controller to PLC)

First word in Response Area	Hexadecimal notation	Bit				Description
		15 - 12	11 - 8	7 - 4	3 - 0	
+2	3000	0011	0000	0000	0000	Command code
+3	0070	0000	0000	0111	0000	Response target command codes
+4	-	0000	0000	0000	0000	Response code
+5	-	0000	0000	0000	0000	Command execution result OK: 0 (0000 0000) NG: Not 0 (0000 0000)

Save Image Data

Saves the image data stored in the the Sensor Controller's memory.

Command (PLC to Sensor Controller)

First word in Command Area	Hexadecimal notation	Bit				Description
		15 - 12	11 - 8	7 - 4	3 - 0	
+2	4000	0100	0000	0000	0000	Command code
+3	0070	0000	0000	0111	0000	
+4	-	0000	0000	0000	0000	Image data No.
+5	-	0000	0000	0000	0000	
+6	-	0000	0000	0000	0000	[Absolute path of save destination and save filename]
+7	-	0000	0000	0000	0000	
:	-	0000	0000	0000	0000	Up to 256 characters

Response (Sensor Controller to PLC)

First word in Response Area	Hexadecimal notation	Bit				Description
		15 - 12	11 - 8	7 - 4	3 - 0	
+2	4000	0100	0000	0000	0000	Command code
+3	0070	0000	0000	0111	0000	Response target command codes
+4	-	0000	0000	0000	0000	Response code
+5	-	0000	0000	0000	0000	Command execution result OK: 0 (0000 0000) NG: Not 0 (0000 0000)

Save All Image Data

Saves all image data in the Sensor Controller's memory with ifz format in external storage.

Command (PLC to Sensor Controller)

First word in Command Area	Hexadecimal notation	Bit				Description
		15 - 12	11 - 8	7 - 4	3 - 0	
+2	4010	0100	0000	0001	0000	Command code
+3	0070	0000	0000	0111	0000	
+4	-	0000	0000	0000	0000	[Absolute path of save destination]
+5	-	0000	0000	0000	0000	
:	-	0000	0000	0000	0000	(The file name is given automatically.) Up to 256 characters

Response (Sensor Controller to PLC)

First word in Response Area	Hexadecimal notation	Bit				Description
		15 - 12	11 - 8	7 - 4	3 - 0	
+2	4010	0100	0000	0001	0000	Command code Response target command codes
+3	0070	0000	0000	0111	0000	
+4	-	0000	0000	0000	0000	Response code Command execution result OK: 0 (0000 0000) NG: Not 0 (0000 0000)
+5	-	0000	0000	0000	0000	

Save Last Logging Image

Saves the last logging image.

Command (PLC to Sensor Controller)

First word in Command Area	Hexadecimal notation	Bit				Description
		15 - 12	11 - 8	7 - 4	3 - 0	
+2	4020	0100	0000	0010	0000	Command code
+3	0070	0000	0000	0111	0000	
+4	-	0000	0000	0000	0000	[Absolute path of save destination and save filename] Up to 256 characters
+5	-	0000	0000	0000	0000	
:	-	0000	0000	0000	0000	

Response (Sensor Controller to PLC)

First word in Response Area	Hexadecimal notation	Bit				Description
		15 - 12	11 - 8	7 - 4	3 - 0	
+2	4020	0100	0000	0010	0000	Command code Response target command codes
+3	0070	0000	0000	0111	0000	
+4	-	0000	0000	0000	0000	Response code Command execution result OK: 0 (0000 0000) NG: Not 0 (0000 0000)
+5	-	0000	0000	0000	0000	

Save All Data

Saves the system + scene group 0 data that is currently used by the Sensor Controller in a file.

Command (PLC to Sensor Controller)

First word in Command Area	Hexadecimal notation	Bit				Description
		15 - 12	11 - 8	7 - 4	3 - 0	
+2	5000	0101	0000	0000	0000	Command code
+3	0070	0000	0000	0111	0000	
+4	-	0000	0000	0000	0000	[Absolute path of save destination and save filename] Up to 256 characters
+5	-	0000	0000	0000	0000	
:	-	0000	0000	0000	0000	

Response (Sensor Controller to PLC)

First word in Response Area	Hexadecimal notation	Bit				Description
		15 - 12	11 - 8	7 - 4	3 - 0	
+2	5000	0101	0000	0000	0000	Command code
+3	0070	0000	0000	0111	0000	Response target command codes
+4	-	0000	0000	0000	0000	Response code
+5	-	0000	0000	0000	0000	Command execution result OK: 0 (0000 0000) NG: Not 0 (0000 0000)

Capture Screen

Captures the screen.

The argument specifies a file name and extension in the absolute path of the save destination. The extension is "bmp". If there is no argument, the folder in which the captured image is saved is determined by the system data settings, and the file name is the time stamp. The extension is "bmp".

For details, refer to *Capturing Screen Images* in the *Vision System FH/FHV Series User's Manual* (Cat. No. Z365).

Command (PLC to Sensor Controller)

First word in Command Area	Hexadecimal notation	Bit				Description
		15 - 12	11 - 8	7 - 4	3 - 0	
+2	6000	0110	0000	0000	0000	Command code
+3	0070	0000	0000	0111	0000	
+4	-	0000	0000	0000	0000	[Absolute path of save destination and save filename] When 0000 0000 is set in +4 or higher, the command operates without an argument
+5	-	0000	0000	0000	0000	
:	-	0000	0000	0000	0000	

Response (Sensor Controller to PLC)

First word in Response Area	Hexadecimal notation	Bit				Description
		15 - 12	11 - 8	7 - 4	3 - 0	
+2	6000	0110	0000	0000	0000	Command code
+3	0070	0000	0000	0111	0000	Response target command codes
+4	-	0000	0000	0000	0000	Response code
+5	-	0000	0000	0000	0000	Command execution result OK: 0 (0000 0000) NG: Not 0 (0000 0000)

A-1-5 Non-procedure Command Details

This section describes details of commands used in Non-procedure communications.

ALLIMAGESAVE or AIS

Writes all the image data in the image buffer (specified with **main unit logging image**) to external storage in ifz format.

<Command format>



or



<Response format>

When processing is performed normally:



When processing is not performed normally:



<Parameters explanation>

Destination folder name	The folder name to save image data. Specify the folder name as an absolute path. The save destination to use differs by Sensor Controller model.	
	Save destination	FH series/FHV series*1
	RAMDisk	C:\Data\RAMDisk
	External storage	E:\, F:\, G:\, H:\, M:\, S:\, T:\, U:\, V:\, W:\, X:\, Y:\, Z:\

*1. Do not specify a save destination other than RAMDisk or External storage.
The saved Scene data area may be reduced and the Sensor Controller will not perform correctly.

(Example)

When you save the data to *IMG01* folder of *RAMDisk*:

<Command>



<Response>



BKDLOAD

Reads system + scene group 0 data.

<Command format>

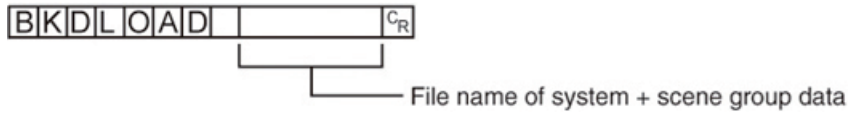

<Response format>

When processing is performed normally:

OK^{C_R}

When processing is not performed normally:

ER^{C_R}

<Parameters explanation>

File name of system + scene group data	The name of the file containing the System data and Scene group 0 data you wish to load. Specify the file name as an absolute path. The file name needs the <i>BKD</i> extension. The file which has <i>BKD</i> extension can be load. The load destination to use differs by Sensor Controller model.	
	Load destination	FH series/FHV series
	RAMDisk	C:\Data\RAMDisk
External storage	E:\, F:\, G:\, H:\, M:\, S:\, T:\, U:\, V:\, W:\, X:\, Y:\, Z:\	



Precautions for Correct Use

Do not turn off the power to the Sensor Controller until there is a response.

(Example)

When loading *LABEL1.BKD* in the *IMG01* folder of *RAMDisk* to the Sensor Controller:

<Command>

B|K|D|L|O|A|D| |C : \ Data \ RAMDisk \ IMG01 \ LABEL1.BKD|^{C_R}

<Response>

OK^{C_R}

BKDSAVE

The system + scene group 0 data currently being used by the Sensor Controller is saved to a file.

<Command format>

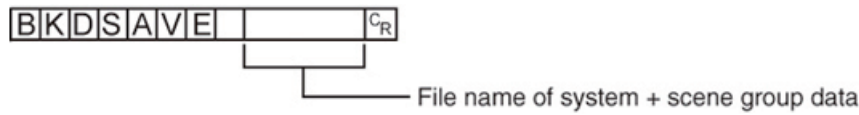

<Response format>

When processing is performed normally:

OK^{CR}

When processing is not performed normally:

ER^{CR}

<Parameters explanation>

File name of system + scene group data	The name of the file containing the System data and Scene group 0 data you wish to save. Specify the folder name as an absolute path. The file name needs the <i>BKD</i> extension. The save destination to use differs by Sensor Controller model.	
	Save destination	FH series/FHV series*1
	RAMDisk	C:\Data\RAMDisk
External storage	E:\, F:\, G:\, H:\, M:\, S:\, T:\, U:\, V:\, W:\, X:\, Y:\, Z:\	

*1. Do not specify a save destination other than RAMDisk or External storage, i.e. C:\ProgramFiles\FZ. The saved Scene data area may be reduced and the Sensor Controller will not perform correctly.



Precautions for Correct Use

Do not turn off the power to the Sensor Controller until there is a response.

(Example)

When saving the currently used system data and scene group 0 data as the file name *LABEL1.BKD* in the *IMG01* folder of *RAMDisk*:

<Command>

BKDSAVE C:\Data\RAMDisk\IMG01\LABEL1.BKD^{CR}

<Response>

OK^{CR}

BRUNCHSTART or BFU

Branches to the flow head (processing unit No. 0).

This command can only be executed when the corresponding flow control processing item is used.

<Command format>

BRUNCHSTART^{C_R}

or

BFU^{C_R}

<Response format>

When processing is performed normally:

OK^{C_R}

When processing is not performed normally:

ER^{C_R}

CLRMEAS

Clears all of the measurement values of the current scene.

<Command format>

CLRMEAS^{C_R}

<Response format>

When processing is performed normally:

OK^{C_R}

When processing is not performed normally:

ER^{C_R}

Window display status after clearing

Judgment result	Unmeasured (0)
Value	0
Character string	Null character

CPYSCEN or CSD

Copies the data for the scene with the number specified with command argument 1 to the scene with the number specified with command argument 2. If there is already data at the copy destination, the copied data is written over that data.

<Command format>

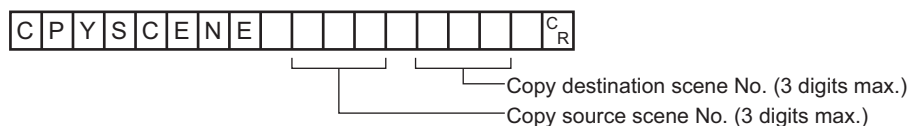

or

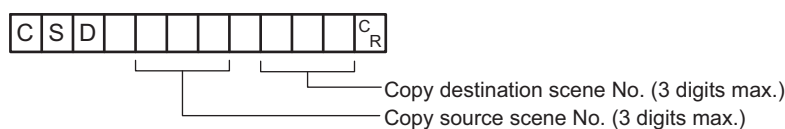

<Response format>

When processing is performed normally:

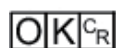

When processing is not performed normally:



<Parameters explanation>

Copy destination scene No.	Specifies the scene No. to copy from (0 to the number of scenes in the scene group – 1).
Copy destination scene No.	Specifies the scene No. to copy to (0 to the number of scenes in the scene group – 1).

(Example)

Copying the scene data for Scene 2 to Scene 10:

<Command>

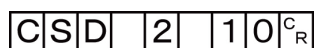

<Response>



DATALOGCOND or DLC

Getting the data logging condition

Gets the data logging condition for system data.

Gets the *data logging condition* on the logging setting screen.

<Command format>

DATA LOG COND^{C_R}

or

DLC^{C_R}

<Response format>

When processing is performed normally:

Data logging condition^{C_R}

OK^{C_R}

When processing is not performed normally:

ER^{C_R}

<Parameters explanation>

Data logging condition	0: None 1: Only NG 2: All
------------------------	---------------------------------

(Example)

When data logging condition is set to *None*:

<Command>

DLC^{C_R}

<Response>

O^{C_R}

OK^{C_R}

Setting the data logging condition

Sets the data logging conditions for system data.

Sets the *Data logging condition* on the Logging Setting window .

<Command format>

DATA LOG COND ^{C_R}

└── Data logging condition

or

D L C ^{C_R}

└── Data logging condition

<Response format>

When processing is performed normally:

OK ^{C_R}

When processing is not performed normally:

ER ^{C_R}

<Parameters explanation>

Data logging condition	0: None 1: Only NG 2: All
------------------------	---------------------------------

(Example)

When setting the data logging condition to All:

<Command>

D L C 2 ^{C_R}

<Response>

OK ^{C_R}

DATALOGFOLDER or DLF

Getting the data logging folder name

Gets the set data logging folder name.

<Command format>

DATALOGFOLDER^{C_R}

or

DLF^{C_R}

<Response format>

When processing is performed normally:

Data logging folder name^{C_R}

OK^{C_R}

When processing is not performed normally:

ER^{C_R}

<Parameters explanation>

Data logging folder name	Responds with the data logging folder name with its absolute path.
--------------------------	--

(Example)

When setting the logging data save destination to *RAMDisk*:

<Command>

DLF^{C_R}

<Response>

C:\Data\RAMDisk\^{C_R}

OK^{C_R}

Setting the data logging folder name

Sets the data logging folder name.

<Command format>

DATASAVE

Saves System + Scene group data to the Sensor Controller's memory.

<Command format>

D**A****T****A****S****A****V****E****C_R**

<Response format>

When processing is performed normally:

O**K****C_R**

When processing is not performed normally:

E**R****C_R**



Additional Information

- Executing DATASAVE command while you use Scene group 1 to 31, System + Scene group data is saved to the Sensor Controller's memory.
 - Do not turn off the power to the Sensor Controller until there is a response.
-

DATE

Getting date and time

Gets the date and time from the internal calendar timer in the Sensor Controller.

<Command format>

DATE^{CR}

<Response format>

When processing is performed normally:

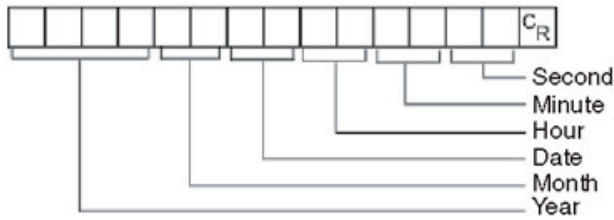

OK^{CR}

When processing is not performed normally:

ER^{CR}

<Parameters explanation>

Year/Month/Date/Hour/Minute/Second	Year: 4 digits Month: 2 digits Date: 2 digits Hour: 2 digits Minute: 2 digits Second: 2 digits
------------------------------------	---

(Example)

When the current date and time is 08/30/2007, 12:30:00:

<Command>

DATE^{CR}

<Response>

20070830123000^{CR}

Setting date and time

Changes the date and time of the internal calendar timer in the Sensor Controller.

<Command format>

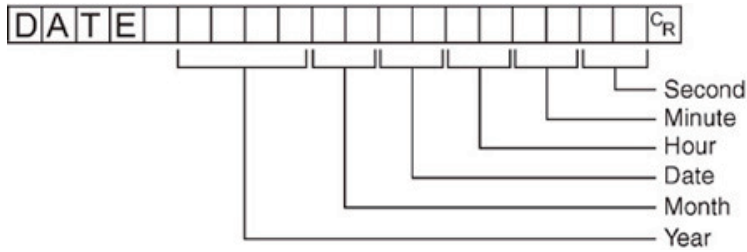

<Response format>

When processing is performed normally:

OK^{CR}

When processing is not performed normally:

ER^{CR}



Additional Information

<Hour: 2 digits>, <Minute: 2 digits>, and <Second: 2 digits> can be omitted during setting. Settings cannot be updated when these are omitted, however, and the previous time will be kept unchanged.

Allowable omission patterns include *omitting <second> only*, *omitting <minute> and <second>*, and *omitting <hour>, <minute>, and <second>*. Patterns that cannot be used include *omitting <hour> only* and *omitting <minute> only*.

(Example)

When changing the date and time to 8/30/2007, 12:30:00:

<Command>

DATE 20070830123000^{CR}

<Response>

OK^{CR}

DELSCENE or DSD

Deletes the data for the scene whose number is specified with command argument 1.

<Command format>

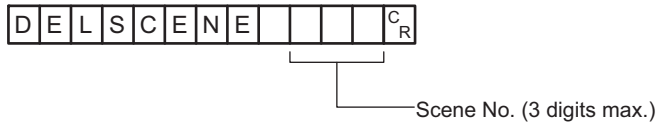

or

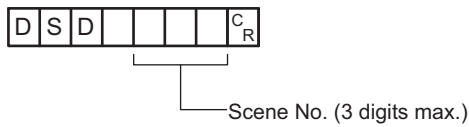

<Response format>

When processing is performed normally:

OK^{C_R}

When processing is not performed normally:

ER^{C_R}

<Parameters explanation>

Scene No.	Specify the scene No. to delete the scene data for (0 to the number of scenes in the scene group -1).
-----------	---

(Example)

Deleting the scene data for Scene 2:

<Command>

DSD 2^{C_R}

<Response>

OK^{C_R}

DIOFFSET or DIO

Gets or sets the value of the parallel DI terminal offset data.

The parallel DI terminal offset is the value that is added to the DI0 to DI4 command parameter when a parallel command is executed.

It is convenient to use a parallel DI terminal offset in cases such as the following.

Example: Creating a custom communications command for parallel communications that sets a numeric value using DI0 to DI6:

- Without an Offset:

You can set only values between the minimum value of 0 and the maximum value of 27 (0111 1111 binary).

- With an Offset:

Adding an offset of 100 allows you to specify numeric values from a minimum value of 100 to a maximum value of 227 (127+ 100) by specifying the same values as those used without offsets.

Getting the parallel DI terminal offset data

Gets the parallel DI terminal offset data.

After the Set Parallel Terminal Offset command was performed to set the offset value, this command is only performed properly.

<Command format>

D I O F F S E T ^{C_R}

or

D I O ^{C_R}

<Response format>

When processing is performed normally:

Terminal offset data ^{C_R}

OK ^{C_R}

When processing is not performed normally:

ER ^{C_R}

<Parameters explanation>

Parallel DI terminal offset data	This is the value that is set for the parallel DI terminal offset data (0 - 9999).
----------------------------------	--

(Example)

When the parallel DI terminal offset data is 10:



Additional Information

When the value of the parallel DI terminal offset data is set to 10, the Switch Scene parallel command will change the scene to scene 10 instead of scene 0 when 0 is specified in the target scene parameter.

<Command>

D I O^{C_R}

<Response>

1 0^{C_R}

OK^{C_R}

Sets the parallel DI terminal offset data

Sets the parallel DI terminal offset data.

<Command format>

D I O F F S E T ^{C_R}

Parallel DI terminal offset data (max. 4 digits)

or

D I O ^{C_R}

Parallel DI terminal offset data (max. 4 digits)

<Response format>

When processing is performed normally:

OK^{C_R}

When processing is not performed normally:

ER^{C_R}

<Parameters explanation>

Parallel DI terminal offset data	This is the value that is set for the parallel DI terminal offset data (0 - 9999).
----------------------------------	--

(Example)

Setting the parallel DI terminal offset data to 10.

<Command>

D I O 1 0 ^{C_R}

<Response>

OK ^{C_R}

DIPORTCOND or DPC

Gets the ON/OFF states of all parallel DI terminals at once.

For how to use the command to get status, refer to the following example.

Example:

To get the parallel DI terminal status of Line 0.

1. Send the parallel DI terminal status command to the port number assigned to Line 0.
2. A response of the parallel DI terminal status will be received.

<Command format>

D I P O R T C O N D ^{C_R}

or

D P C ^{C_R}

<Response format>

When processing is performed normally:

Terminal state ^{C_R}

OK ^{C_R}

When processing is not performed normally:

ER ^{C_R}

<Parameters explanation>

Terminal state	Responds with the DI0-DI7 states (0-255). • 1st bit: DI0 • 2nd bit: DI1 : • 8th bit: DI7
----------------	--



Precautions for Correct Use

This command gets the terminal state of each line by specifying its port number. When getting the terminal state of an unusable line, the response code will be OK and the response data will always be 0. Check the status of the received data by changing the actual parallel terminal status.

(Example)

When DI0 and DI4 are ON:

<Command>

D P C^{C_R}

<Response>

1 7^{C_R}

OK^{C_R}

DOPORTCOND or DPC

Sets the ON/OFF states of all parallel DO terminals at once.

For how to set the DO terminal state, refer to the following.

Example:

When you set the parallel DO terminal state of Line 0 to ON:

1. Set the command which turns the terminal state ON to the parallel DO terminal of assignment BIT.
2. Send the command set in the above step 1 to the port number of Line 0.
3. Executed result is responded.

<Command format>

D O P O R T C O N D ^{C_R}

Terminal state (max. 5 digits)

or

D P C ^{C_R}

Terminal state (max. 5 digits)

<Response format>

When processing is performed normally:

OK^{C_R}

When processing is not performed normally:

ER^{C_R}

<Parameters explanation>

Terminal state	Specify the DO terminals to switch ON (0-65535). <ul style="list-style-type: none"> • 1st bit: DO0 2nd bit: DO1 : 16th bit: DO15
----------------	--



Precautions for Correct Use

This command sets the terminal state of each line by specifying its port number. When the terminal state of an unusable or a different line was set, the response code will be OK and the set terminal state will be discarded. Check the status of the received data by changing the actual parallel terminal status.

(Example)

When setting DO0 and DO4 ON:

<Command>

D P C 1 7 ^{C_R}

<Response>

O K ^{C_R}

ECHO or EEC

Returns as is any character string sent by an external device.
Only single-byte alphanumerics can be used.

<Command format>

E C H O [] [] [] [] [] [] [] [] [] [] [] [] [] [] ^{C_R}

Arbitrary character string (256 characters max.)

or

E E C [] [] [] [] [] [] [] [] [] [] [] [] [] [] ^{C_R}

Arbitrary character string (256 characters max.)

<Response format>

When processing is performed normally:

Same character string ^{C_R}

O K ^{C_R}

When processing is not performed normally:

ER^{C_R}

<Parameters explanation>

Arbitrary character string	Sets the character string returned as is. The response is the character string set here as is.
----------------------------	--

(Example)

When returning the character string "TEST."

<Command>

E E C T E S T^{C_R}

<Response>

T E S T^{C_R}

OK^{C_R}

IMAGECAPTURE or EIC

Captures the screen.

- No argument: The file name will be the time stamp. The file is stored in the designated folder in the system data setting.
- Argument: Specify the save destination and file name in the parameter. If the file name extension is other than ".bmp", then ".bmp" is added to the file name.

<Command format>

No argument:

I M A G E C A P T U R E^{C_R}

or

E I C^{C_R}

With argument:

I M A G E C A P T U R E []^{C_R}

File name (256 characters max.)

or

E I C []^{C_R}

File name (256 characters max.)

<Response format>

When processing is performed normally:

OK^{CR}

When processing is not performed normally:

ER^{CR}

<Parameters explanation>

File name	The folder name to save image data when image logging performs. Specify the folder name as an absolute path. The file name needs the "BMP" extension. The save destination to use differs by Sensor Controller model.	
	Save destination	FH series/FHV series ^{*1}
	RAMDisk	C:\Data\RAMDisk
	External storage	E:\, F:\, G:\, H:\, M:\, S:\, T:\, U:\, V:\, W:\, X:\, Y:\, Z:\

*1. Do not specify a save destination other than RAMDisk or External storage, i.e. C:\ProgramFiles\FZ
The saved Scene data area may be reduced and the Sensor Controller will not perform correctly.

(Example)

When capturing an image to the file named *abc.bmp* of *RAMDisk*.

<Command>

E I C C : \ Data \ RAMDisk \ abc.bmp^{CR}

<Response>

OK^{CR}

IMAGECAPTUREFOLDER or ICF

Getting the screen capture folder name

Gets the set screen capture folder name.

<Command format>

```
IMAGECAPTUREFOLDERCR
```

or

```
ICFCR
```

<Response format>

When processing is performed normally:

```
Screen capture folder nameCR
```

```
OKCR
```

When processing is not performed normally:

```
ERCR
```

<Parameters explanation>

Screen capture folder name	Responds with the name of the folder that the screen capture is saved to with its absolute path.
----------------------------	--

(Example)

When the screen capture save destination is set to *RAMDisk*:

<Command>

```
ICFCR
```

<Response>

```
C:\Data\RAMDisk\CR
```

```
OKCR
```

Setting the screen capture folder name

Sets the screen capture folder name.

<Command format>

I M A G E C A P T U R E F O L D E R [] C_R

Screen capture folder name
(128 characters max.)

or

I C F [] C_R

Screen capture folder name (128 characters max.)

<Response format>

When processing is performed normally:

OK C_R

When processing is not performed normally:

ER C_R

<Parameters explanation>

Screen capture folder name	Image display window number. Specify the folder name as an absolute path. The save destination to use differs by Sensor Controller model.	
	Save destination	FH series/FHV series*1
	RAMDisk	C:\Data\RAMDisk
	External storage	E:\, F:\, G:\, H:\, M:\, S:\, T:\, U:\, V:\, W:\, X:\, Y:\, Z:\

*1. Do not specify a save destination other than RAMDisk or External storage, i.e. C:\ProgramFiles\FZ
The saved Scene data area may be reduced and the Sensor Controller will not perform correctly.

(Example)

When setting the screen capture folder name to *RAMDisk*:

<Command>

I C F C : \ Data \ RAMDisk \ C_R

<Response>

OK C_R

IMAGEDISPCOND or IDC

Gets image mode

Gets the image mode for the specified Image Display window.

<Command format>

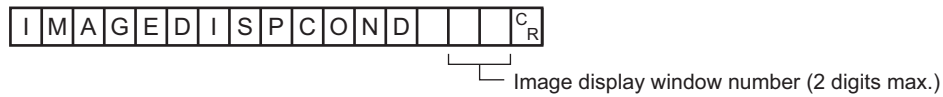

or

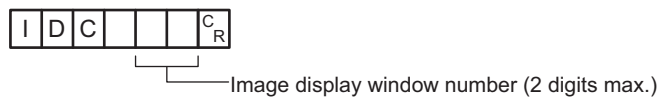

<Response format>

When processing is performed normally:

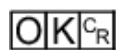
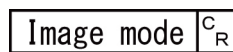

When processing is not performed normally:



<Parameters explanation>

Image display window number	Image display window number (0 to 23)
Image mode	0: Through 1: Freeze 2: Last NG

(Example)

When getting the image mode of the image display window 1 (through):

<Command>



<Response>



Sets image mode

Sets the image mode for the specified Image Display window.

<Command format>

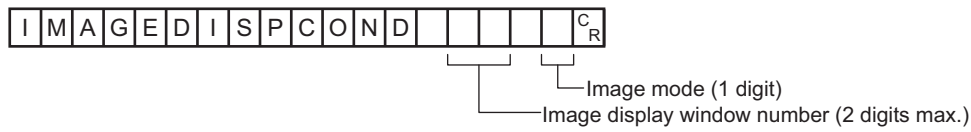

or



<Response format>

When processing is performed normally:

OK C_R

When processing is not performed normally:

ER C_R

<Parameters explanation>

Image display window number	Image display window number (0 to 23)
Image mode	0: Through 1: Freeze 2: Last NG

(Example)

When setting *Last NG* for the image mode for the image display window 1:

<Command>

I D C 1 2 C_R

<Response>

OK C_R

IMAGEFIT or EIF

Returns the display position and display zoom ratio for the image display window to their default values.

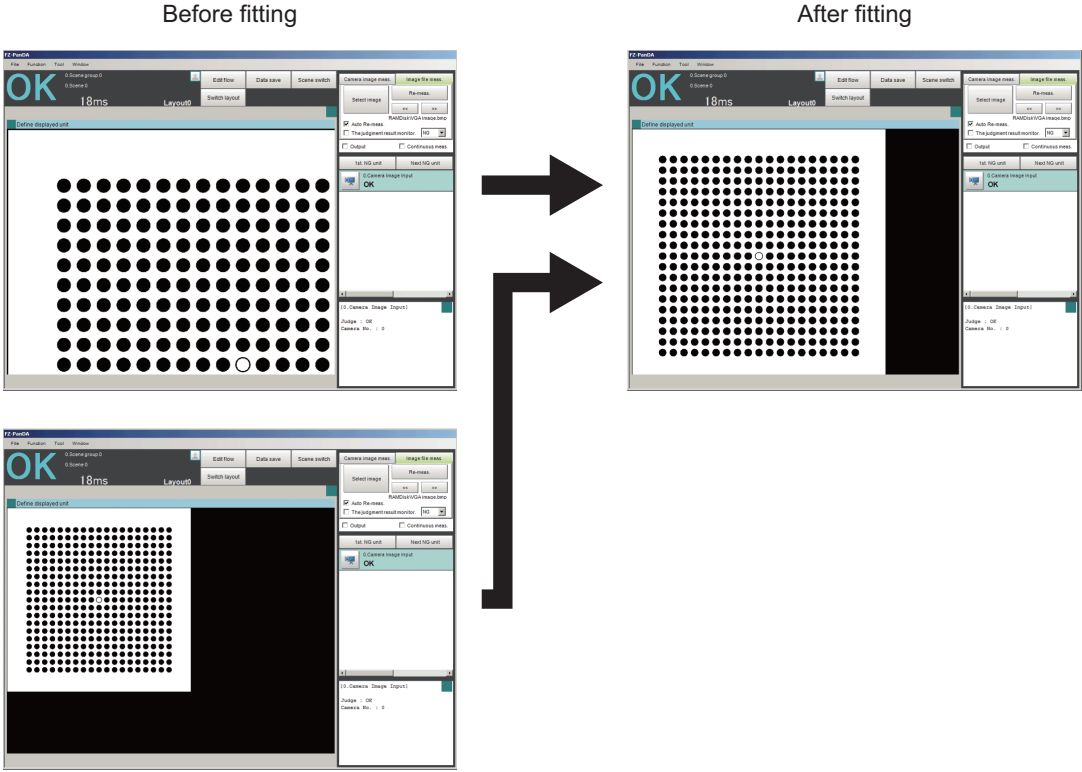

<Command format>



or

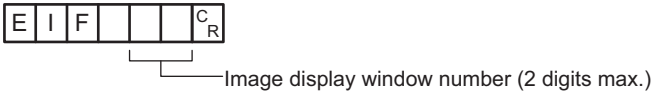

<Response format>

When processing is performed normally:



When processing is not performed normally:



<Parameters explanation>

Image display window number	Number of the image display window to return the display position and display magnification to their default values. (0 to 23)
-----------------------------	--

(Example)

When returning the display position and display zoom ratio for the image display window 1 to their default values

<Command>

E I F 1^{C_R}

<Response>

OK^{C_R}

IMAGELOGFOLDER or ILF

Getting the image logging folder name

Gets the set image logging folder name.

<Command format>

```
IMAGELOGFOLDERCR
```

or

```
ILFCR
```

<Response format>

When processing is performed normally:

```
Image logging prefixCR
```

```
OKCR
```

When processing is not performed normally:

```
ERCR
```

<Parameters explanation>

Image logging folder name	Responds with the name of the folder the logging image is saved to with its absolute path.
---------------------------	--

(Example)

When the image logging save destination is set to *RAMDisk*:

<Command>

```
ILFCR
```

<Response>

```
C:\Data\RAMDisk\CR
```

```
OKCR
```

Setting the image logging folder name

Sets the image logging folder name.

<Command format>

I M A G E L O G F O L D E R [] C_R

Image logging folder name
(128 characters max.)

or

I L F [] C_R

Image logging folder name
(128 characters max.)

<Response format>

When processing is performed normally:

OK C_R

When processing is not performed normally:

ER C_R

<Parameters explanation>

Image Logging folder name	The folder name to save image data when image logging performs. Specify the folder name as an absolute path. The save destination to use differs by Sensor Controller model.	
	Save destination	FH series/FHV series*1
	RAMDisk	C:\Data\RAMDisk
External storage	E:\, F:\, G:\, H:\, M:\, S:\, T:\, U:\, V:\, W:\, X:\, Y:\, Z:\	

*1. Do not specify a save destination other than RAMDisk or External storage.
The saved Scene data area may be reduced and the Sensor Controller will not perform correctly.

(Example)

When setting the image logging folder name to *RAMDisk*:

<Command>

I L F C : \ Data \ RAMDisk \ C_R

<Response>

OK C_R

IMAGELOGHEADER or ILH

Getting the prefix for the name of the file the image logging is saved to

Gets the prefix for the name of the file the image logging is saved to. The maximum length of the prefix character string is 32 characters.

<Command format>

```
I M A G E L O G H E A D E R CR
```

or

```
I L H CR
```

<Response format>

When processing is performed normally:

```
Image logging prefix CR
```

```
OK CR
```

When processing is not performed normally:

```
ER CR
```

<Parameters explanation>

Image logging prefix	Responds with the prefix for the name of the file the image logging is saved to.
----------------------	--

(Example)

When the prefix for the name of the file the image logging is saved to is set to *abc*:

<Command>

```
I L H CR
```

<Response>

```
OK CR
```

Setting the prefix for the name of the file the image logging is saved to

Sets the prefix for the name of the file the image logging is saved to. The maximum length of the prefix character string is 32 characters.

<Command format>



or



<Response format>

When processing is performed normally:

`OK`^{C_R}

When processing is not performed normally:

`ER`^{C_R}

<Parameters explanation>

Image logging prefix	Sets the prefix for the name of the file the image logging is saved to (with a maximum of 32 characters). The set character string is added at the beginning of the name of the save file.
----------------------	---

(Example)

When setting *abc* as the prefix for the name of the file the image logging is saved to:

<Command>

`ILH abc`^{C_R}

<Response>

`OK`^{C_R}

IMAGESCROLL or EIS

The image display window whose number is specified is moved the specified distance in parallel. The setting range for the movement distance is not restricted. Also, because the scale for movement is independent of the display zoom ratio, the movement is not affected by change in the zoom ratio.

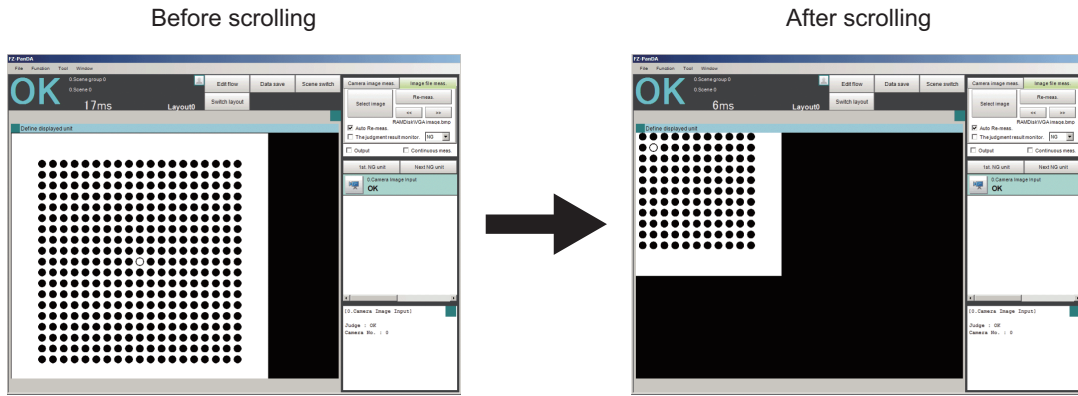

<Command format>

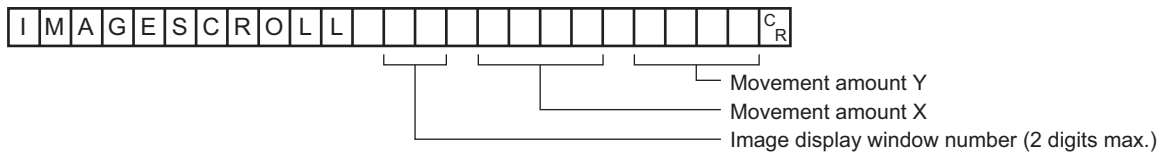

or

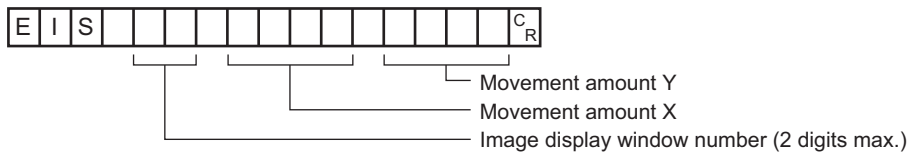

<Response format>

When processing is performed normally:

OK^{CR}

When processing is not performed normally:

ER^{CR}

<Parameters explanation>

Image display window number	Number of the image display window to return the display position and display magnification to their default values. (0 to 23)
Movement amount X	Sets the X-direction movement distance (camera coordinate system).
Movement amount Y	Sets the Y-direction movement distance (camera coordinate system).

(Example)

When moving the image display window 1 image in parallel 20 in the X direction and 10 in the Y direction:

<Command>

E I S 1 2 0 1 0 C_R

<Response>

OK C_R

IMAGESUBNO or ISN

Getting the number of the currently displayed sub-image.

Gets the number of the sub-image currently displayed in the specified image display window.

<Command format>

I M A G E S U B N O C_R

Image display window number (2 digits max.)

or

I S N C_R

Image display window number (2 digits max.)

<Response format>

When processing is performed normally:

Sub image number C_R

OK C_R

When processing is not performed normally:

ER C_R

<Parameters explanation>

Image display window number	Number of the image display window for which to get the image mode. (0 to 23)
Sub image number	Responds with the number of the sub-image displayed in the image display window.

(Example)

When setting 2 as the number of the sub-image displayed in image display window 1.

<Command>

I S N 1 C_R

<Response>

OK^{CR}

OK^{CR}

Setting the number of the currently displayed sub-image

Sets the number of the sub-image displayed in the specified image display window.

<Command format>

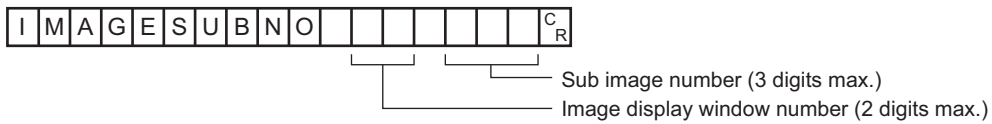

or

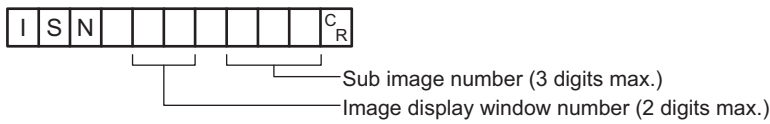

<Response format>

When processing is performed normally:

OK^{CR}

When processing is not performed normally:

ER^{CR}

<Parameters explanation>

Image display window number	Number of the image display window for which to get the image mode. (0 to 23)
Sub image number	Sets the number (0 to 31) of the sub-image displayed in the current image display window.

(Example)

When getting the number of the sub-image being displayed in image display window 1:

<Command>

I S N 1 2^{CR}

<Response>

OK^{CR}

IMAGEUNITNO or IUN

Getting the number of the currently displayed unit

Gets the number of the unit currently displayed in the specified image display window.

<Command format>

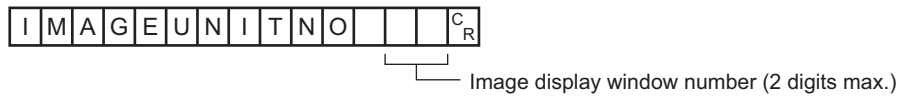

or

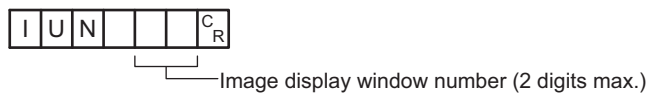

<Response format>

When processing is performed normally:

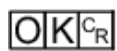
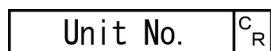

When processing is not performed normally:



<Parameters explanation>

Image display window number	Number of the image display window for which to get the unit number. (0 to 23)
Unit No.	Responds with the number of the unit displayed in the current image display window.

(Example)

When getting the number (0) of the unit being displayed in image display window 1:

<Command>



<Response>



Setting the number of the displayed unit

Sets the number of the unit displayed in the specified image display window.

IMAGEZOOM or EIZ

Zooms the image display window whose number is specified in or out to the specified zoom ratio. The zoom ratio here is the ratio compared to the original image (100%).

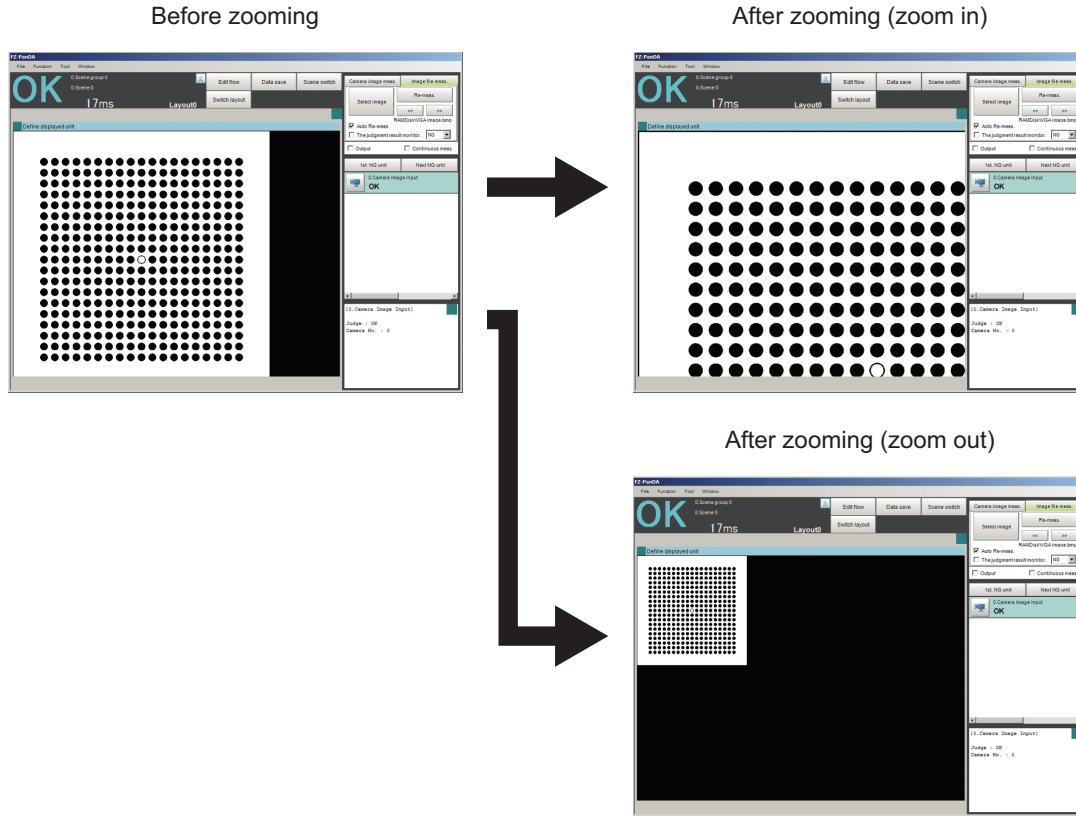

<Command format>

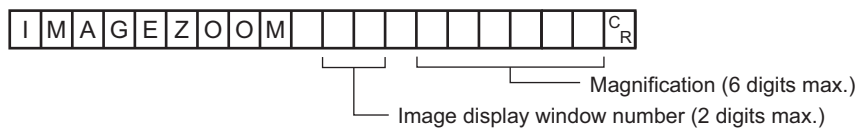

or

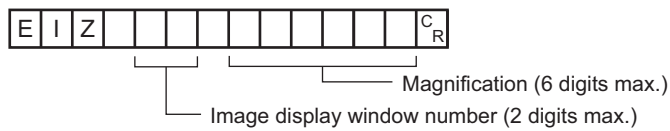

<Response format>

When processing is performed normally:

OK^{CR}

When processing is not performed normally:

ER^{CR}

<Parameters explanation>

Image display window number	Number of the image display window to return the display position and display magnification to their default values. (0 to 23)
Magnification	Sets the zoom ratio (250-16,000). 250 means 25%; 16,000 means 1600%.

(Example)

When zooming in image display window 1 to 200%:

<Command>

E I Z 1 2000 C_R

<Response>

OK C_R

IMGSAVE

Saves image data.

<Command format>



<Response format>

When processing is performed normally:

OK C_R

When processing is not performed normally:

ER C_R

<Parameters explanation>

Image data No.	<p>Specifies the No. of the image data to be saved(0 to max. number of logging images (I_MAX)).*1</p> <p>The maximum number of logging images can be a number with a maximum of 3 digits. The number of images will vary depending on the Sensor Controller used and the camera connected. The image data number of the latest image is 0.</p> <p>For details of the maximum number of images that can be logged (I_MAX), refer to <i>Number of Logged Images</i> in the <i>Vision System FH/FHV Series User's Manual (Cat. No. Z365)</i>.</p>
----------------	--

Destination folder name	The folder name to save image data. Specify the folder name as an absolute path. The file name needs the "IFZ" extension. The save destination to use differs by Sensor Controller model.	
	Save destination	FH series/FHV series*2
	RAMDisk	C:\Data\RAMDisk
External storage	E:\, F:\, G:\, H:\, M:\, S:\, T:\, U:\, V:\, W:\, X:\, Y:\, Z:\	

- *1. The maximum number of images that can be logged depends on the model of the Sensor Controller that you use and the models and number of connected Cameras
For details of the maximum number of images that can be logged (I_MAX), refer to *Number of Logged Images* in the *Vision System FH/FHV Series User's Manual (Cat. No. Z365)*.
- *2. Do not specify a save destination other than RAMDisk or External storage, i.e. C:\ProgramFiles\FZ
The saved Scene data area may be reduced and the Sensor Controller will not perform correctly.



Precautions for Correct Use

- If the specified file name already exists, this existing file will be overwritten.
- Do not turn off the power to the Sensor Controller until there is a response.

(Example)

When saving the image data of image data number3 with file name LABEL1.IFZ in the IMG01 folder of RAMDisk:

<Command>

I	M	G	S	A	V	E		3		C	:	\	D	a	t	a	\	R	A	M	D	i	s	k	\	I	M	G	0	1	\	L	A	B	E	L	1	.	I	F	Z	C _R
---	---	---	---	---	---	---	--	---	--	---	---	---	---	---	---	---	---	---	---	---	---	---	---	---	---	---	---	---	---	---	---	---	---	---	---	---	---	---	---	---	---	----------------

<Response>

O	K	C _R
---	---	----------------

INPUTTRANSSTATE or ITS

Getting communication module input states

Gets the input state (permitted/prohibited) for communication modules.

<Command format>

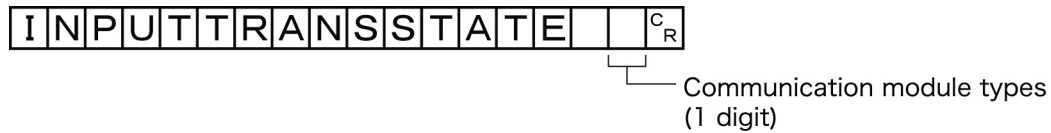

or

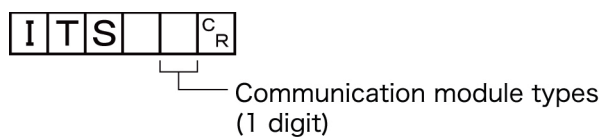

<Response format>

When processing is performed normally:

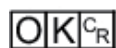
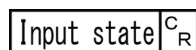

When processing is not performed normally:



<Parameters explanation>

Communication module types	0: Serial (Ethernet) 1: Serial (RS-232C) 2: Parallel IO 3: Fieldbus 4: Remote operation
Input state	0: Prohibited 1: Permitted

(Example)

Getting the input status when serial (Ethernet) inputs are enabled (= 1):

<Command>



<Response>



OK^{C_R}

Setting communication module input states

Permits/prohibits input to communication modules.

Any communication module whose input state is set to Prohibit (0) accepts no communications whatsoever. However, inputs related to hardware (parallel STEP signals/DSA signals and ECAT STEP, etc.) are not included in the prohibition.

<Command format>

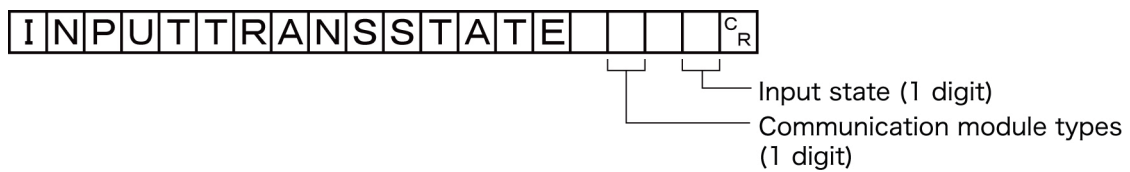

or

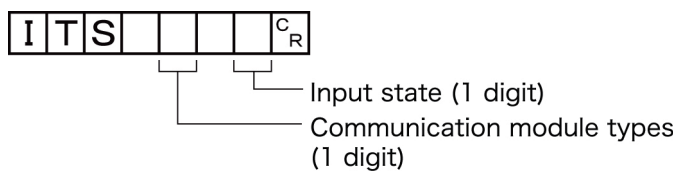

<Response format>

When processing is performed normally:

OK^{C_R}

When processing is not performed normally:

ER^{C_R}

(Example)

Setting the serial (RS-232C) input state to prohibited:

<Command>

I T S followed by three empty boxes and **0^{C_R}**

<Response>

OK^{C_R}

LASTIMAGESAVE or LIS

Executes a save of the last input image.

The character string handed over by the argument is used as the file name.

<Command format>

LASTIMAGESAVE [] C_R
 File name (max. 256 digits)

or

LIS [] C_R
 File name (max. 256 digits)

<Response format>

When processing is performed normally:

OK C_R

When processing is not performed normally:

ER C_R

<Parameters explanation>

File name	The folder name to save image data. Specify the folder name as an absolute path. The save destination differs by Sensor Controller model.	
	Save destination	FH series/FHV series*1
	RAMDisk	C:\Data\RAMDisk
External storage	E:\, F:\, G:\, H:\, M:\, S:\, T:\, U:\, V:\, W:\, X:\, Y:\, Z:\	

*1. Do not specify a save destination other than RAMDisk or External storage.
 The saved Scene data area may be reduced and the Sensor Controller will not perform correctly.

(Example)

When saving the last input image to the file named *abc.ifz* of *RAMDisk*:

<Command>

LIS C:\Data\RAMDisk\abc.ifz C_R

<Response>

OK C_R



Additional Information

- When the extension is ifz, the image is saved with the specified file name.
- When the extension is anything other than ifz, the image is saved with ifz appended to the file name.
- If there is no extension (only the folder name is given), the image is saved to a file named time stamp .ifz.

LAYOUTNO or DLN

Gets or sets the current layout number.



Precautions for Correct Use

For non-remote operation, only 0: Local can be specified. For remote operation, only 1: Remote can be specified.
If any combination other than the above is used, unexpected operation may occur when the command is executed.

Getting the layout number

Gets the number of the currently displayed layout.

<Command format>

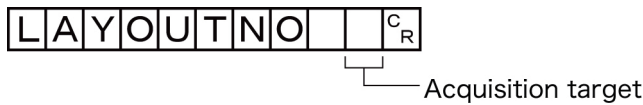

or

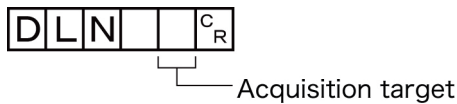

<Response format>

When processing is performed normally:

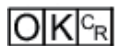
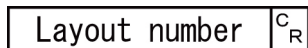

When processing is not performed normally:



<Parameters explanation>

Acquisition target	0: Local 1: Remote
Layout number	Current layout number (0 to 8)

(Example)

When the currently displayed window (local) is the RUN window::

<Command>

DLN 0^{CR}

<Response>

OK^{CR}

Setting the layout number

Sets the layout number and switches the window.

<Command format>

LAYOUTNO ^{CR}

└──┬──┘ └──┬──┘
Layout number Setting target

or

DLN ^{CR}

└──┬──┘ └──┬──┘
Layout number Setting target

<Response format>

When processing is performed normally:

OK^{CR}

When processing is not performed normally:

ER^{CR}

(Example)

When displaying the RUN window (local):

<Command>

DLN 0 1^{CR}

<Response>

OK^{CR}

LOGINACCOUNT or LAI

Gets the user name for the currently logged in user account.

Gets the user ID for the currently logged in account.

<Command format>

L	O	G	I	N	A	C	C	O	U	N	T			C _R
---	---	---	---	---	---	---	---	---	---	---	---	--	--	----------------

└─┬─┘ Acquisition target (1 digit)

or

L	A	I			C _R
---	---	---	--	--	----------------

└─┬─┘ Acquisition target (1 digit)

<Response format>

When processing is performed normally:

User ID	C _R
---------	----------------

OK	C _R
----	----------------

When processing is not performed normally:

ER	C _R
----	----------------

<Parameters explanation>

Acquisition target	0: Local 1: Remote
User ID	Returns the user ID in the user account used by the user currently logging in.

(Example)

Getting the name of the user (*abc*) that is currently logged in (local):

<Command>

L	A	I		0	C _R
---	---	---	--	---	----------------

<Response>

a	b	c	C _R
---	---	---	----------------

OK	C _R
----	----------------

Switching the currently logged in account

Switches the currently logged in account.

<Command format>

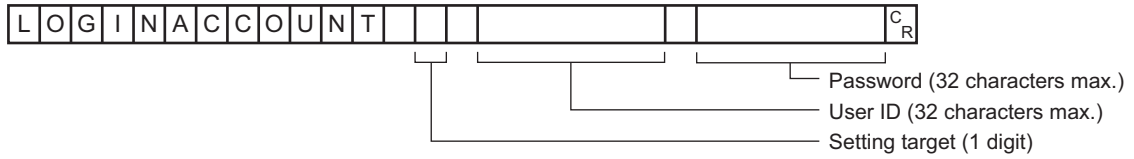

or

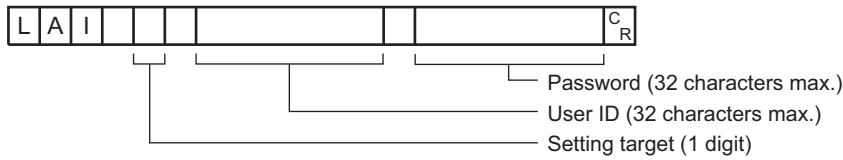

<Response format>

When processing is performed normally:

OK^{CR}

When processing is not performed normally:

ER^{CR}

<Parameters explanation>

Settable Objects	0: Local 1: Remote
User ID	Specify the ID for the user to switch (32 characters maximum).
Password	Specify the password for the user to switch (32 characters maximum).

(Example)

When switching to user ID *abc* with password *efg* (local):

<Command>

L A I 0 a b c e f g^{CR}

<Response>

OK^{CR}

LOGINACCOUNTGROUP or LAG

Gets the group ID in the user account used by the user currently logging in.

<Command format>

L	O	G	I	N	A	C	C	O	U	N	T	G	R	O	U	P			C _R
---	---	---	---	---	---	---	---	---	---	---	---	---	---	---	---	---	--	--	----------------

└─┬─┘ Acquisition target (1 digit)

or

L	A	G			C _R
---	---	---	--	--	----------------

└─┬─┘ Acquisition target (1 digit)

<Response format>

When processing is performed normally:

Group ID	C _R
----------	----------------

OK^{C_R}

When processing is not performed normally:

ER^{C_R}

<Parameters explanation>

Acquisition target	0: Local 1: Remote
Group ID	Returns the group ID in the user account used by the user currently logging in.

(Example)

The following sample command returns user group ID *UG1* in the user account used by the user currently logging in:

<Command>

LAG 0^{C_R}

<Response>

1^{C_R}

OK^{C_R}

MEASURE or M

Executing measurement

Executes measurement one time.

<Command format>

MEASURE^{CR} or **M^{CR}**

<Response format>

When processing is performed normally:

- Non-procedure

OK^{CR}
Measurement result^{CR}

- Normal (Fxxx series)

Measurement result^{CR}
OK^{CR}

When processing is not performed normally:

ER^{CR}



Additional Information

For Normal (Fxxx series method), refer to *2-5-9 Command Formats* on page 2-347.

<Parameters explanation>

Measurement result	When "Data Output" or "Result Output (Message)" is set in the flow, the measurement results are output. When "Data Output" or "Result Output (Message)" is not set, the measurement results are not output. Refer to <i>2-5-11 Output Format</i> on page 2-353.
--------------------	---

Starts continuous measurement

Starts continuous measurement.

<Command format>

MEASURE / ^{CR}

<Response format>

When processing is performed normally:

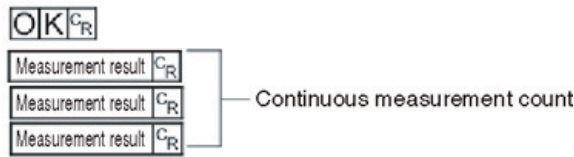

When processing is not performed normally:

`ERCR`

<Parameters explanation>

Measurement result	When "Data Output" is set in the flow, the measurement results are output. When "Data Output" is not set, the measurement results are not output. Refer to 2-5-11 <i>Output Format</i> on page 2-353.
--------------------	---

Completes continuous measurement

Continuous measurement ends.

<Command format>

`MEASURE / ERCR`

<Response format>

When processing is performed normally:

`OKCR`

When processing is not performed normally:



Additional Information

To output measurement results, insert a *Data Output* processing unit in the scene. When the scene does not have a *Data Output* processing unit, only a command response is output. For detail, refer to 2-5-11 *Output Format* on page 2-353 and 2-2-5 *Output Data Settings (Processing Item Registration)* on page 2-155.

MEASUREUNIT or MTU

Performs a test measurement on the specified unit.

<Command format>

MEASUREUNIT ^{C_R}

└── Unit No.

or

MTU ^{C_R}

└── Unit No.

<Response format>

When processing is performed normally:

OK ^{C_R}

When processing is not performed normally:

ER ^{C_R}

<Parameters explanation>

Unit No.	Specifies the unit number to run a test with: 0 to the uppermost unit model number in the scene.
----------	--

(Example)

The following sample command runs a test on unit number 5:

<Command>

MTU ^{C_R}

<Response>

OK ^{C_R}

MOVESCENE or MSD

Copies the data for the scene with the number specified with command argument 1 to the scene with the number specified with command argument 2. Deletes scene data with a number specified by command argument 1 after completing copying. If there is already data at the copy destination, the copied data is written over that data.

<Command format>

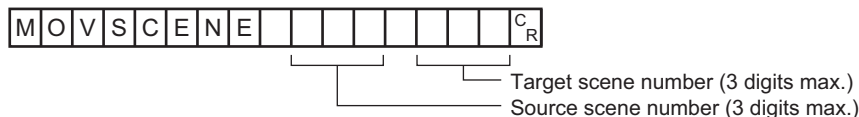

or

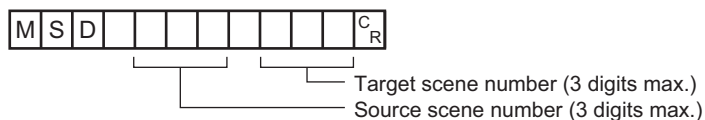

<Response format>

When processing is performed normally:

OK^{CR}

When processing is not performed normally:

ER^{CR}

<Parameters explanation>

Source scene number	Specifies the scene number to copy scene data from: 0 to the number of the scenes in the scene group -1.
Target scene number	Specifies the target scene number for copying scene data: 0 to the number of the scenes in the scene group -1.

(Example)

The following sample command moves the scene data saved under scene 2 to scene 10:

<Command>

MSD 2 10^{CR}

<Response>

OK^{CR}

OPELOGCOND or OLC

Gets logging operation state

Gets the logging operation state.

<Command format>

OPELOGCOND^{C_R}

or

OLC^{C_R}

<Response format>

When processing is performed normally:

Logging operation state^{C_R}

OK^{C_R}

When processing is not performed normally:

ER^{C_R}

<Parameters explanation>

Logging operation state	0: OFF 1: ON
-------------------------	-----------------

(Example)

The following sample command returns an enabled logging operation state:

<Command>

OLC^{C_R}

<Response>

1^{C_R}

OK^{C_R}

Sets logged operation state

Sets the logged operation state. This command allows configuring the logging operation state in the same manner as for the Start/End Logging Operation buttons on the Main screen.

<Command format>

OPELOGCOND ^{C_R}

Logging operation state (1 digit)

or

OLC ^{C_R}

Logging operation state (1 digit)

<Response format>

When processing is performed normally:

OK ^{C_R}

When processing is not performed normally:

ER ^{C_R}

(Example)

The following sample command enables the logging operation state:

<Command>

OLC 1 ^{C_R}

<Response>

OK ^{C_R}

OUTPUTTRANSSTATE or OTS

Gets output state to external device

Gets the output state to an external device: Enabled or Disabled:

<Command format>

OUTPUTTRANSSTATE ^{C_R}

or

OTS ^{C_R}

<Response format>

When processing is performed normally:

Output state ^{C_R}

OK ^{C_R}

When processing is not performed normally:

ER^{CR}

<Parameters explanation>

Output state	0: Prohibited 1: Permitted
--------------	-------------------------------

(Example)

The following sample command retrieves the output state, *Enabled*:

<Command>

OTS^{CR}

<Response>

1^{CR}

OK^{CR}

Sets the output state to external device

Permits/prohibits output to external devices.

When the input state is disabled, i.e., set to (0), all the communications modules are unable to transmit data.

<Command format>

OUTPUTTRANSSTATE ^{CR}

└── Output state (1 digit)

or

OTS ^{CR}

└── Output state (1 digit)

<Response format>

When processing is performed normally:

OK^{CR}

When processing is not performed normally:

ER^{CR}

(Example)

Setting the output status to external devices to prohibited or prohibiting output to external devices:

<Command>

OTS O^{C_R}

<Response>

OK^{C_R}

PARAALLCOND or PAC

Gets all parallel terminal states at once, except for DI terminals

Gets the ON/OFF states of all parallel terminals at once, except for DI terminals.

For how to set, refer to the following contents or example.

Example:

When you want to get the parallel terminal state of Line 0 except DO to turn ON at once:

1. Send this command to the port number set on Line 0.
2. The parallel terminal state except DI is responded.

<Command format>

PARAALLCOND^{C_R}

or

PAC^{C_R}

<Response format>

When processing is performed normally:

Terminal state^{C_R}

OK^{C_R}

When processing is not performed normally:

ER^{C_R}

<Parameters explanation>

Terminal state	Terminal state 0: OFF 1: ON For assigned terminal to each bit, refer to *1.
----------------	--

*1: Assigned terminal to each bit

FH-2000 / FH5000 series Sensor Controller

Support- ed bit	Terminal							
	Line 0	Line 1	Line 2	Line 3	Line 4	Line 5	Line 6	Line 7
BIT0	STEP0	STEP1	STEP2	STEP3	STEP4	STEP5	STEP6	STEP7
BIT1	DSA0	DSA1	0	0	0	0	0	0
BIT2	DILINE0	DILINE0	DILINE0	DILINE0	DILINE0	DILINE0	DILINE0	DILINE0
BIT3	DILINE1	DILINE1	DILINE1	DILINE1	DILINE1	DILINE1	DILINE1	DILINE1
BIT4	DILINE2	DILINE2	DILINE2	DILINE2	DILINE2	DILINE2	DILINE2	DILINE2
BIT5	0	0	0	0	0	0	0	0
BIT6	0	0	0	0	0	0	0	0
BIT7	0	0	0	0	0	0	0	0
BIT8	0	0	0	0	0	0	0	0
BIT9	0	0	0	0	0	0	0	0
BIT10	0	0	0	0	0	0	0	0
BIT11	0	0	0	0	0	0	0	0
BIT12	0	0	0	0	0	0	0	0
BIT13	0	0	0	0	0	0	0	0
BIT14	0	0	0	0	0	0	0	0
BIT15	0	0	0	0	0	0	0	0

FH-L series Sensor Controller

Supported bit	Terminal
	Line 0
BIT0	STEP0
BIT1	DSA0
BIT2	0
BIT3	0
BIT4	0
BIT5	0
BIT6	0
BIT7	0
BIT8	0
BIT9	0
BIT10	0
BIT11	0
BIT12	0
BIT13	0
BIT14	0
BIT15	0



Precautions for Correct Use

- When the Multi-line Random-trigger mode is selected in the following series, usable signal type or assignment are differ depending on the used number of Lines.
 - FH-2000 series
 - FH-5000 series
 For more details of Operation mode, refer to *Multi-line Random-trigger Mode Signal Specifications* on page 2-391.
- The terminal status of each line can be got by sending this command to the port number allocated to them. For signals that are common in all lines, the terminal status can be got from any line used.

When the terminal status for an unusable line or a different line was got, the response code will be OK and the response data will always be 0.

Check the status of the received data by changing the actual parallel terminal status.

(Example)

The following sample command returns the state of enabled STEP0 and DSA0:

<Command>

PAC^{C_R}

<Response>

3^{C_R}

OK^{C_R}

The response of 0000 0000 0000 0011 (binary) is given as 3 (decimal).

Sets all parallel terminal states at once, except for DO terminals

Sets the ON/OFF state of all Parallel terminals except for DO terminals.

For how to set, refer to the following:

Example)

When you want to set the Parallel DO terminals state of Line 0, to ON at once:

1. Set the terminals state ON to the desired assignment BIT of the Parallel DO terminal state.
2. Send the specified command set in the above step 1 to the port number of Line 0.
3. Executed result of command is responded.

<Command format>



or

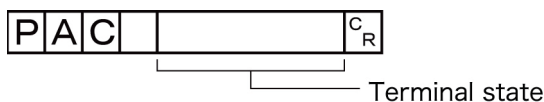

<Response format>

When processing is performed normally:

OK^{CR}

When processing is not performed normally:

ER^{CR}

<Parameters explanation>

Terminal state	Terminal state 0: OFF 1: ON For assigned terminal to each bit, refer to *1.
----------------	--

***1: Assigned terminal to each bit**

FH-2000 / FH-5000 series Sensor Controller

Support- ed bit	Terminal							
	Line 0	Line 1	Line 2	Line 3	Line 4	Line 5	Line 6	Line 7
BIT0	RUN0	RUN1	RUN2	RUN3	-	-	-	-
BIT1	ERROR /ERROR0	ERROR1	ERROR2	ERROR3	ERROR	ERROR	ERROR	ERROR
BIT2	BUSY0	BUSY1	BUSY2	BUSY3	BUSY4	BUSY5	BUSY6	BUSY7
BIT3	OR0	OR1	OR2	OR3	OR4	OR5	OR6	OR7
BIT4	GATE0	GATE1	-	-	-	-	-	-
BIT5	READY0	READY1	READY2	READY3	READY4	READY5	READY6	READY7
BIT6	ACK	ACK	ACK	ACK	ACK	ACK	ACK	ACK
BIT7	-	-	-	-	-	-	-	-
BIT8	-	-	-	-	-	-	-	-
BIT9	-	-	-	-	-	-	-	-
BIT10	-	-	-	-	-	-	-	-
BIT11	-	-	-	-	-	-	-	-
BIT12	-	-	-	-	-	-	-	-
BIT13	-	-	-	-	-	-	-	-
BIT14	-	-	-	-	-	-	-	-
BIT15	-	-	-	-	-	-	-	-

FH-L series Sensor Controller

Supported bit	Terminal
	Line 0
BIT0	RUN
BIT1	ERROR
BIT2	BUSY
BIT3	OR0
BIT4	GATE0
BIT5	READY0
BIT6	ACK
BIT7	-

Supported bit	Terminal
	Line 0
BIT8	-
BIT9	-
BIT10	-
BIT11	-
BIT12	-
BIT13	-
BIT14	-
BIT15	-



Precautions for Correct Use

- When the Multi-line Random-trigger mode is selected in the following series, usable signal type or assignment are differ depending on the used number of Lines.
 - FH-2000 series
 - FH-5000 series

For more details of Operation mode, refer to *Multi-line Random-trigger Mode Signal Specifications* on page 2-391.
- The terminal status of each line can be got by sending this command to the port number allocated to them. For signals that are common in all lines, the terminal status can be got from any line used.

When the terminal state of an unusable or a different line was set, the response code will be OK and the set terminal state will be discarded.

Check the status of the received data by changing the actual parallel terminal status.

(Example)

The following sample command activates OR0:

<Command>

P A C 8_{C_R}

<Response>

OK_{C_R}

PARAPORTCOND or PPC

Gets the specified status of parallel I/O

Gets the ON/OFF information of specified parallel I/O terminal.

Specify the parallel terminal with combination of terminal type and terminal number.

For how to set, refer to the following:

Example:

When you want to get the terminal status of STEP0 and Line0

1. Set 0 in terminal type, STEP is specified.
2. Set 0 in terminal number, STEP0 of Line0 is specified.
3. Send the specified command set in the above step 1 and 2 to the port number of Line0.
4. The specified terminal status is responded.

<Command format>

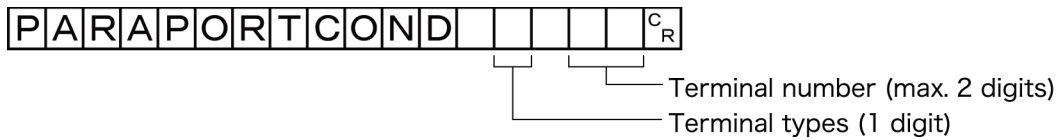

or

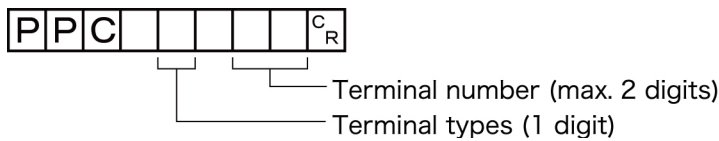

<Response format>

When processing is performed normally:

Terminal state^{CR}

OK^{CR}

When processing is not performed normally:

ER^{CR}

<Parameters explanation>

Terminal type	Set the terminal by combining Terminal number. Specified terminal differ according to the Sensor Controller series. For detail, refer to *1.
Terminal number	Set the terminal by combining Terminal type. Specified terminal differ according to the Sensor Controller series. For detail, refer to *1.
Terminal state	0: OFF 1: ON

*1 : Terminal type and Terminal number

FH-2000 / FH-5000 series Sensor Controller

Terminal type		Terminal number							
		0	1	2	3	4	5	6	7
STEP	0	STEP0	STEP1	STEP2	STEP3	STEP4	STEP5	STEP6	STEP7
DSA	1	DSA0	DSA1	-	-	-	-	-	-
DI	2	DIO	DI1	DI2	DI3	DI4	DI5	DI6	DI7
DI LINE	11	DILINE0	DILINE1	DILINE2	-	-	-	-	-

FH-L series Sensor Controller

Terminal type		Terminal number							
		0	1	2	3	4	5	6	7
STEP	0	STEP0	-	-	-	-	-	-	-
DSA	1	DSA0	-	-	-	-	-	-	-
DI	2	DIO	DI1	DI2	DI3	DI4	DI5	DI6	DI7
DI LINE	11	-	-	-	-	-	-	-	-



Precautions for Correct Use

- When the Multi-line Random-trigger mode is selected in the following series, usable signal type or assignment are differ depending on the used number of Lines.
 - FH-2000 series
 - FH-5000 series
 For more details of Operation mode, refer to *Multi-line Random-trigger Mode Signal Specifications* on page 2-391.
- The terminal status of each line can be got by sending this command to the port number allocated to them. For signals that are common in all lines, the terminal status can be got from any line used.

When the terminal status for an unusable line or a different line was got, the response code will be OK and the response data will always be 0.

Check the status of the received data by changing the actual parallel terminal status.

(Example)

The following sample command gets the state of STEP1:

<Command>

P P C 0 1 C_R

<Response>

1 C_R

OK C_R

Sets the state of specified parallel I/O terminal

Sets the specified parallel I/O terminal: ON/OFF

Specifies the Parallel terminal with a combination of terminal type, terminal number and terminal status.

For how to set, refer to the following contents or example.

Example:

When you want to set the OR3 terminal status of Line 3:

1. Set 6 in terminal type, OR is specified.
2. Set 6 in terminal type, OR3 is specified.
3. Set 1 in terminal type, OR3 terminal is set to OFF→ON.
4. Sends the specified command which set the above step 1 and 3 to the port number of Line 3.
5. Executed result of command is responded.

<Command format>

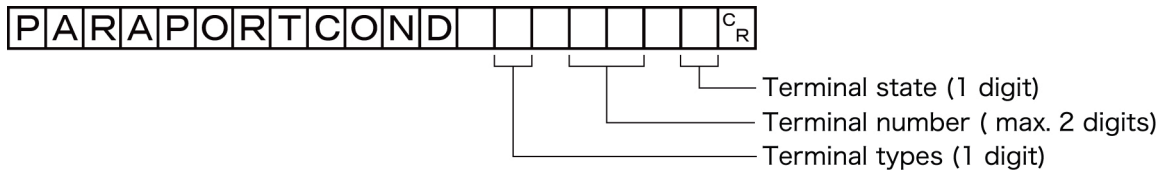

or

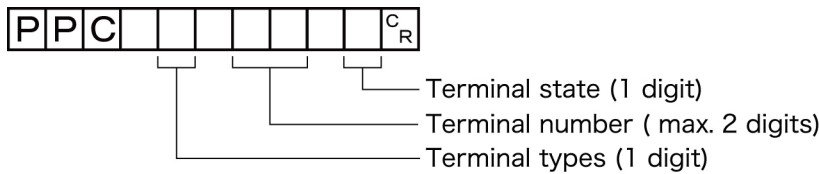

<Response format>

When processing is performed normally:

OK^{C_R}

When processing is not performed normally:

ER^{C_R}

<Parameters explanation>

Terminal type	Set the terminal by combining Terminal number. Specified terminal differs according to the Sensor Controller series. For detail, refer to *1.
Terminal number	Set the terminal by combining Terminal type. Specified terminal differs according to the Sensor Controller series. For detail, refer to *1.
Terminal state	0: OFF 1: ON

***1: Terminal type and terminal number**

a. FH-2000 / FH-5000 series Sensor Controller

Terminal type		Terminal number							
		0	1	2	3	4	5	6	7
RUN	3	RUN0	RUN1	RUN2	RUN3	-	-	-	-
ERR	4	ERROR/ ERROR0	ERROR1	ERROR2	ERROR3	-	-	-	-

Terminal type		Terminal number							
		0	1	2	3	4	5	6	7
BUSY	5	BUSY0	BUSY1	BUSY2	BUSY3	BUSY4	BUSY5	BUSY6	BUSY7
OR	6	OR0	OR1	OR2	OR3	OR4	OR5	OR6	OR7
GATE	7	GATE0	GATE1	-	-	-	-	-	-
READY	8	READY0	READY1	READY2	READY3	READY4	READY5	READY6	READY7
DO	9	DO0	DO1	DO2	DO3	DO4	DO5	DO6	DO7
ACK	10	ACK	-	-	-	-	-	-	-

Terminal type		Terminal number							
		8	9	10	11	12	13	14	15
RUN	3	-	-	-	-	-	-	-	-
ERR	4	-	-	-	-	-	-	-	-
BUSY	5	-	-	-	-	-	-	-	-
OR	6	-	-	-	-	-	-	-	-
GATE	7	-	-	-	-	-	-	-	-
READY	8	-	-	-	-	-	-	-	-
DO	9	DO8	DO9	DO10	DO11	DO12	DO13	DO14	DO15
ACK	10	-	-	-	-	-	-	-	-

b. FH-L series Sensor Controller

Terminal type		Terminal number							
		0	1	2	3	4	5	6	7
RUN	3	RUN	-	-	-	-	-	-	-
ERR	4	ERROR	-	-	-	-	-	-	-
BUSY	5	BUSY0	-	-	-	-	-	-	-
OR	6	OR0	-	-	-	-	-	-	-
GATE	7	GATE0	-	-	-	-	-	-	-
READY	8	READY0	-	-	-	-	-	-	-
DO	9	DO0	DO1	DO2	DO3	DO4	DO5	DO6	DO7
ACK	10	-	-	-	-	-	-	-	-

Terminal type		Terminal number							
		8	9	10	11	12	13	14	15
RUN	3	-	-	-	-	-	-	-	-
ERR	4	-	-	-	-	-	-	-	-
BUSY	5	-	-	-	-	-	-	-	-
OR	6	-	-	-	-	-	-	-	-
GATE	7	-	-	-	-	-	-	-	-
READY	8	-	-	-	-	-	-	-	-
DO	9	DO8	DO9	DO10	DO11	DO12	DO13	DO14	DO15
ACK	10	-	-	-	-	-	-	-	-



Precautions for Correct Use

- When the Multi-line Random-trigger mode is selected in the following series, usable signal type or assignment are differ depending on the used number of Lines.
 - FH-2000 series
 - FH-5000 series

For more details of Operation mode, refer to *Multi-line Random-trigger Mode Signal Specifications* on page 2-391.

- The terminal status of each line can be got by sending this command to the port number allocated to them. For signals that are common in all lines, the terminal status can be got from any line used.

When the terminal state of an unusable or a different line was set, the response code will be OK and the set terminal state will be discarded.

Check the status of the received data by changing the actual parallel terminal status.

(Example)

Setting OR0 to ON:

<Command>

P	P	C	6	0	1	C _R
---	---	---	---	---	---	----------------

<Response>

O	K	C _R
---	---	----------------

REGIMAGE or RID

Registers specified image data as registered image.

Registers the data of a specified image as a registered image.

The status after the command was executed is the same as after the operation was executed for the Register Button in the Registered Image Manager. When the source to register is 0, the last measured image, command argument 3, can be omitted.

<Command format>

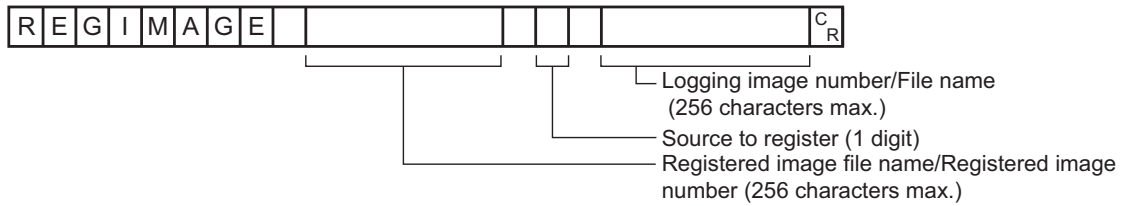

or

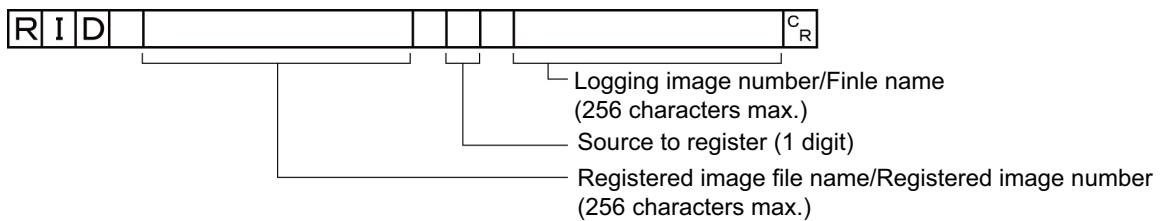

<Response format>

When processing is performed normally:

OK^{CR}

When processing is not performed normally:

ER^{CR}

<Parameters explanation>

Registered image file name/Registered image number	Specifies a registered image file name (0 to 256 characters) or a registered image number (000 to 999). To specify a file inside a subfolder, specify the subfolder name as well.
Source to register	0: Last measured image 1: System logging image 2: Image file
Logging image number/ File name	If you have specified a system logging image as the source to register, specify a logging image number: 0 to the number of the logging system images - 1. If you have specified an image file, specify a file name with 0 to 256 characters. To specify a file inside a subfolder, specify the subfolder name as well.

(Example)

a. When registering a last measured image as *ABC.ifz* of the registered image file.

<Command>

R I D A B C . I F Z 0^{C_R}

<Response>

OK^{C_R}

b. When registering an image with registered image number 100 and logging image number 10:

<Command>

R I D 1 0 0 1 1 0^{C_R}

<Response>

OK^{C_R}

Loads specified image data as registered image

Loads a specified registered image as a measured image. The status after the command is executed is the same as after the operation is executed for the Read Button in the Registered Image Manager.

<Command format>

REG I M A G E []^{C_R}

Registered image number (max. 3 digits)

or

R I D []^{C_R}

Registered image file name/Registered image number (256 characters max.)

<Response format>

When processing is performed normally:

OK^{C_R}

When processing is not performed normally:

ER^{C_R}

<Parameters explanation>

Registered image file name/Registered image number	Specifies a registered image file name (0 to 256 characters) or a registered image number (000 to 999). To specify a file inside a subfolder, specify the subfolder name as well.
--	--

(Example)

a. When loading a registered image file, *ABC.ifz*, as a measured image:

<Command>

R I D A B C . I F Z ^{C_R}

<Response>

OK ^{C_R}

b. When loading an image with registered image number 100 as a measured image:

<Command>

R I D 1 0 0 ^{C_R}

<Response>

OK ^{C_R}



Precautions for Correct Use

JPG (JFZ) format image files cannot be registered or loaded.

RESET

Restart the Sensor Controller.

<Command format>

RESET ^{C_R}

<Response format>

None

SCENE or S

Gets scene number

Gets the current scene No.

<Command format>

SCENE^{CR} or **S^{CR}**

<Response format>

When processing is performed normally:

		C _R
--	--	----------------

└──────────┘ Scene No. (3 digits max.)

O	K	C _R
---	---	----------------

When processing is not performed normally:

ER^{CR}

<Parameters explanation>

Scene No.	The got scene No. (currently used scene No.) is output as a response (0 to 127).
-----------	--

(Example)

When scene 0 is being used:

<Command>

SCENE^{CR}

<Response>

0	C _R
---	----------------

O	K	C _R
---	---	----------------

Switch Scene No.

Switches the scene number to be used.

<Command format>

S	C	E	N	E				C _R
---	---	---	---	---	--	--	--	----------------

└──────────┘ Scene No. (3 digits max.)

<Response format>

When processing is performed normally:

OK^{CR}

When processing is not performed normally:

ER^{CR}

<Parameters explanation>

Scene No.	Specifies the scene No. after switching (0 to 127).
-----------	---

(Example)

When switching to scene 2:

<Command>

SCENE 2^{CR}

<Response>

OK^{CR}

SCNDATA

Gets scene variable value

Gets the value for a scene variable.

<Command format>

S	C	N	D	A	T	A		variable name + type identifier	C _R
---	---	---	---	---	---	---	--	---------------------------------	----------------

<Response format>

When processing is performed normally:

Current value	C _R
---------------	----------------

OK	C _R
----	----------------

When processing is not performed normally:

ER	C _R
----	----------------

<Parameters explanation>

Variable name + type identifier	<p>Specifies a scene variable to get with the variable name and the type identifier.</p> <ul style="list-style-type: none"> Specify a scene variable with the variable name and the type identifier. SC that indicates the kind of variables is not necessary. Ex.: When SC.aaa& is specified, enter aaa& When an array is specified for scene variables, specify its elements. Ex.: Enter like aaa&(10), bbb#(3.5). An error will be returned when the number of array dimensions or the number of its elements is wrongly specified. Ex.: An error is returned if getting bbb#(0) from bbb#(20,10) were attempted. Ex.: An error is returned if getting the value for ccc&(10) were attempted when the defined array variable (ccc&) is one dimension and the number of its elements is five. If a non-existent variable name were specified, an error will be returned depending on the set contents. <ol style="list-style-type: none"> 1) An error is returned if Option Explicit commands are used in Scene control macro. 2) Other than 1), the current value = 0 is returned.
Current value	The current value for the set variable is returned.

Sets value to scene variable

Sets a value to a scene variable.

<Command format>

S	C	N	D	A	T	A		variable name + type identifier			Set value	C _R
---	---	---	---	---	---	---	--	---------------------------------	--	--	-----------	----------------

<Response format>

When processing is performed normally:

OK_{C_R}

When processing is not performed normally:

ER_{C_R}

<Parameters explanation>

Variable name + type identifier	<p>Specifies a scene variable to get with the variable name and the type identifier.</p> <ul style="list-style-type: none"> Specify a scene variable with the variable name and the type identifier. SC that indicates the kind of variables is not necessary. Ex.: When SC.aaa& is specified, enter aaa& When an array is specified for scene variables, specify its elements. Ex.: Enter like aaa&(10), bbb#(3.5). An error will be returned when the number of array dimensions or the number of its elements is wrongly specified. Ex.: An error is returned if getting bbb#(0) from bbb#(20,10) were attempted. Ex.: An error is returned if getting the value for ccc&(10) were attempted when the defined array variable (ccc&) is one dimension and the number of its elements is five. If a non-existent variable name were specified, an error will be returned depending on the set contents. <ol style="list-style-type: none"> An error is returned if Option Explicit commands are used in Scene control macro. Other than 1), the current value = 0 is returned.
Set value	Specifies a value to set.



Precautions for Correct Use

If a different type of value were specified to a variable set by the variable name and the type identifier, an error is not returned but the following processing is applied.

- Although the variable name and type identifier are an integer type, if a floating-point value were set to the variable:
The decimals of the value are rounded down.
(Ex.: When -1.7 is set, -1 is set. When 1.7 is set, 1 is set.)
- Although the variable name and type identifier are a floating-point type, if an integer value were set the variable:
The decimals are added and set. (Ex.: When 35 are set, 35.0 set set.)
- Although the variable name and type identifier are an integer type or a floating-point type, if a character string were set to the variable:
0 is set.
- Although the variable name and type identifier are a character string type, if an integer or floating-point value were set to the variable.
The value is set as a character string.
(Ex.: When 35 is set, the value is set as "35" character string. When 17.1 is set, The value is set as "17.1" character string.)



Additional Information

If the value of a non-existent variable were set when Option Explicit command is not used in Scene control macro, a variable area will be secured and the set value will be set to it. However, the variable will not be displayed in the scene variable window. When the scene variable is newly added, the set value becomes visible.

SCNGROUP or SG

Gets scene group number

Gets the current scene group No.

<Command format>

SCNGROUP^{C_R} or **SG**^{C_R}

<Response format>

When processing is performed normally:

^{C_R}
 Scene group No. (max. 2 digits)

OK^{C_R}

When processing is not performed normally:

ER^{C_R}

<Parameters explanation>

Scene group No.	The acquired scene group No. (currently used scene group No.) is output as a response (0 to 31).
-----------------	--

(Example)

When scene group 0 is being used:

<Command>

SCNGROUP^{C_R}

<Response>

0^{C_R}
OK^{C_R}

Switches the scene group number

Switches the scene group number to be used.

<Command format>

SCNGROUP ^{C_R}
 Scene group No. (max. 2 digits)

<Response format>

When processing is performed normally:

OK^{CR}

When processing is not performed normally:

ER^{CR}

<Parameters explanation>

Scene group No.	Specifies the scene group No. after switching (0 to 31).
-----------------	--

(Example)

When switching to scene group 2:

<Command>

SCNGROUP 2^{CR}

<Response>

OK^{CR}

Precautions for Correct Use

Do not switch the scene group during parallel continuous measurement or when the STEP signal is being input continuously. If you must switch the scene group at one of these times, set *Unchecked* in *Save scene group on scene switch* in either of the settings items below.

- Refer to *Changing the Scene or Scene Group* in the *Vision System FH/FHV Series User's Manual (Cat. No.Z365)*.
- Refer to *Setting the Conditions That Are Related to Operation during Measurement* in the *Vision System FH/FHV Series User's Manual (Cat. No.Z365)*.

SCNSAVE

Saves scene data.

<Command format>

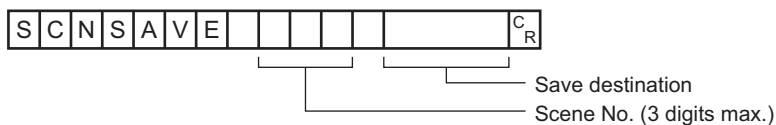

<Response format>

When processing is performed normally:

OK^{CR}

When processing is not performed normally:

ER^{CR}

<Parameters explanation>

Scene number	Specify the Scene number to save. (0 to 127)						
Destination	The name of the file containing the Scene data you wish to save. Specify the file name as an absolute path. The file name needs the "SCN" extension. Save destination folder differ depending on the Sensor Controller series.						
	<table border="1"> <thead> <tr> <th>Save destination</th> <th>FH series/FHV series*1</th> </tr> </thead> <tbody> <tr> <td>RAMDisk</td> <td>C:\Data\RAMDisk</td> </tr> <tr> <td>External storage</td> <td>E:\, F:\, G:\, H:\, M:\, S:\, T:\, U:\, V:\, W:\, X:\, Y:\, Z:\</td> </tr> </tbody> </table>	Save destination	FH series/FHV series*1	RAMDisk	C:\Data\RAMDisk	External storage	E:\, F:\, G:\, H:\, M:\, S:\, T:\, U:\, V:\, W:\, X:\, Y:\, Z:\
	Save destination	FH series/FHV series*1					
RAMDisk	C:\Data\RAMDisk						
External storage	E:\, F:\, G:\, H:\, M:\, S:\, T:\, U:\, V:\, W:\, X:\, Y:\, Z:\						

*1. Do not specify a save destination other than RAMDisk or External storage. The saved Scene data area may be reduced and the Sensor Controller will not perform correctly.



Precautions for Correct Use

- If the specified file name already exists, this existing file will be overwritten.
- Do not turn off the power to the Sensor Controller until there is a response.
- For the FH/FHV series, do not save to a non-volatile area on the C drive (such as C:\ProgramFiles\FZ). This would reduce the storage area for scene data etc. and make correct operation impossible.

(Example)

When saving the scene data of scene data number 3 with file name LABEL1.SCN in the IMG01 folder of RAMDisk:

<Command>

SCNSAVE 3 C:\Data\RAMDisk\IMG01\LABEL1.SCN^{CR}

<Response>

OK^{C_R}

SGRLOAD

Loads scene group data.

<Command format>

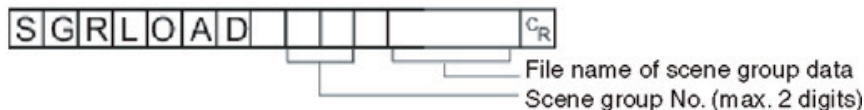

<Response format>

When processing is performed normally:

OK^{C_R}

When processing is not performed normally:

ER^{C_R}

<Parameters explanation>

Scene group No.	Specifies the scene group No. to be loaded (0 to 31)	
File name of Scene group data	The name of the file containing the Scene group data you wish to load. Specify the file name as an absolute path. The file name needs the "SGP" extension. The file which has "SGP" extension can be load. The load destination to use differs by Sensor Controller model.	
	Load destination	FH series/FHV series
	RAMDisk	C:\Data\RAMDisk
	External storage	E:\, F:\, G:\, H:\, M:\, S:\, T:\, U:\, V:\, W:\, X:\, Y:\, Z:\



Precautions for Correct Use

Do not turn off the power to the Sensor Controller until there is a response.

(Example)

When loading *LABEL1.SGP* in the *IMG01* folder of *RAMDisk* to scene group 3:

<Command>

S|G|R|L|O|A|D| |3| |C : \ Data \ RAMDisk \ IMG01 \ LABEL1.SGP|C_R

<Response>

OK^{C_R}



Additional Information

For the USB flash drive, see *Saving Data to the FH/FHV* in the *Vision System FH/FHV Series User's Manual (Cat. No. Z365)*.

SGRSAVE

Saves scene group data.

<Command format>



<Response format>

When processing is performed normally:

OK^{C_R}

When processing is not performed normally:

ER^{C_R}

<Parameters explanation>

Scene group No.	Specifies the scene group No. to save (0 to 31).	
Destination	The name of the file containing the Scene Group data you wish to save. Specify the folder name as an absolute path. The file name needs the "SGP" extension. The save destination folder differs depending on the Sensor Controller series.	
	Save destination	FH series/FHV series *1
	RAMDisk	C:\Data\RAMDisk
External storage	E:\, F:\, G:\, H:\, M:\, S:\, T:\, U:\, V:\, W:\, X:\, Y:\, Z:\	

*1. Do not specify a save destination other than RAMDisk or External storage, i.e. C:\ProgramFiles\FZ. The saved Scene data area may be reduced and the Sensor Controller will not perform correctly.



Precautions for Correct Use

- If the specified file name already exists, this existing file will be overwritten.
- Do not turn off the power to the Sensor Controller until there is a response.
- For the FH/FHV series, do not save to a non-volatile area on the C drive (such as C:\ProgramFiles\FZ). This would reduce the storage area for scene data etc. and make correct operation impossible.

(Example)

When saving the scene group data in scene group number 3 to file name *LABEL1.SGP* in the *IMG01* folder of *RAMDisk*:

<Command>

S|G|R|S|A|V|E| | 3 | C : \ Data \ RAMDisk \ IMG01 \ LABEL1.SGP|C_R

<Response>

OK|C_R

SYSDATA

Gets settings related to logging

Gets settings related to current logging.

<Command format>

S|Y|S|D|A|T|A| | L|o|g|g|i|n|g| | |C_R

└── Identifier

<Response format>

When processing is performed normally:

Measurement value|C_R

OK|C_R

When processing is not performed normally:

ER|C_R

<Parameters explanation>

Data	Identifier	Setting value
Image logging	imageLogging	0: None 1: Only NG 2: All
Folder name of image logging save destination	imageLoggingDirectory	Save destination folder name (one-byte alphanumeric character)
Prefix for image logging file name	imageLoggingHeader	Prefix for image logging file name (one-byte alphanumeric characters)
Data logging	dataLogging	0: None 1: Only NG 2: All
Name of destination folder for saving data logging	dataLoggingDirectory	Save destination folder name (one-byte alphanumeric character)



Precautions for Correct Use

The save destination folder differs depending on the Sensor Controller model. For the FH/FHV series, do not save to a non-volatile area on the C drive (such as C:\ProgramFiles\FZ). This would reduce the storage area for scene data etc. and make correct operation impossible.

Save destination	FH series/FHV series
RAMDisk	C:\Data\RAMDisk
External storage	E:\, F:\, G:\, H:\, M:\, S:\, T:\, U:\, V:\, W:\, X:\, Y:\, Z:\

(Example)

Getting the image logging setting when the setting for the current image logging save condition is 1 (save only NG):

<Command>

S Y S D A T A L o g g i n g i m a g e L o g g i n g C_R

<Response>

1 C_R

OK C_R

The current image logging save condition is 1: *Only NG*.

Changes settings related to logging

Changes settings related to logging.

<Command format>

S Y S D A T A L o g g i n g [] [] C_R
 Setting value Identifier

<Response format>

When processing is performed normally:

OK C_R

When processing is not performed normally:

ER C_R

<Parameters explanation>

Data	Identifier	Setting value
Image logging	imageLogging	0: None 1: Only NG 2: All

Data	Identifier	Setting value
Folder name of image logging save destination	imageLoggingDirectory	Save destination folder name (one-byte alphanumeric character)
Prefix for image logging file name	imageLoggingHeader	Prefix for image logging file name (one-byte alphanumeric characters)
Data logging	dataLogging	0: None 1: Only NG 2: All
Name of destination folder for saving data logging	dataLoggingDirectory	Save destination folder name (one-byte alphanumeric character)



Precautions for Correct Use

The save destination folder differs depending on the Sensor Controller model. For the FH/FHV series, do not save to a non-volatile area on the C drive (such as C:\ProgramFiles\FZ). This would reduce the storage area for scene data etc. and make correct operation impossible.

Save destination	FH series/FHV series
RAMDisk	C:\Data\RAMDisk
External storage	E:\, F:\, G:\, H:\, M:\, S:\, T:\, U:\, V:\, W:\, X:\, Y:\, Z:\

(Example)

a. When creating settings so that data logging is only performed during NG errors:

<Command>

S Y S D A T A L o g g i n g d a t a L o g g i n g 1 C_R

<Response>

OK C_R

SYSLOAD

Loads system data.

<Command format>

S Y S L O A D C_R
 File name of system data

<Response format>

When processing is performed normally:

OK C_R

When processing is not performed normally:

ER^{CR}

<Parameters explanation>

File name of System data	The name of the file containing the System data you wish to load. Specify the file name as an absolute path. The file name needs the "INI" extension. The file which has "INI" extension can be load. The load destination to use differs by Sensor Controller model.	
	Load destination	
	Load destination	FH series/FHV series
	RAMDisk	C:\Data\RAMDisk
	External storage	E:\, F:\, G:\, H:\, M:\, S:\, T:\, U:\, V:\, W:\, X:\, Y:\, Z:\



Precautions for Correct Use

Do not turn off the power to the Sensor Controller until there is a response.

(Example)

When loading *LABEL1.INI* in the *IMG01* folder of *RAMDisk*:

<Command>

S**Y****S****L****O****A****D** | **C** : \ **D** a t a \ **R** a m D i s k \ **I** m g 0 1 \ **L** a b e l 1 . **I** n i ^{CR}

<Response>

OK^{CR}

SYSSAVE

Saves system data.

<Command format>

S**Y****S****S****A****V****E** | ^{CR}
 Save destination

<Response format>

When processing is performed normally:

OK^{CR}

When processing is not performed normally:

ER^{CR}

<Parameters explanation>

Destination	The name of the file containing the System data you wish to save. Specify the folder name as an absolute path. The file name needs the ".INI" extension. Save destination folder differs depending on the Sensor Controller series.	
	Save destination	FH series/FHV series *1
	RAMDisk	C:\Data\RAMDisk
External storage	E:\, F:\, G:\, H:\, M:\, S:\, T:\, U:\, V:\, W:\, X:\, Y:\, Z:\	

*1. Do not specify a save destination other than RAMDisk or External storage, i.e. C:\ProgramFiles\FZ
 The saved Scene data area may be reduced and the Sensor Controller will not perform correctly.



Precautions for Correct Use

- If the specified file name already exists, this existing file will be overwritten.
- Do not turn off the power to the Sensor Controller until there is a response.
- For the FH/FHV series, do not save to a non-volatile area on the C drive (such as C:\ProgramFiles\FZ).
 This would reduce the storage area for scene data etc. and make correct operation impossible.

(Example)

When saving the system data to file name LABEL1.INI in the IMG01 folder of RAMDisk:

<Command>

S Y S S A V E | C : \ D a t a \ R A M D i s k \ I M G 0 1 \ L A B E L 1 . I N I | C R

<Response>

O K | C R

TIMER or TMR

Issues the specified command string after a specified delay.

<Command format>

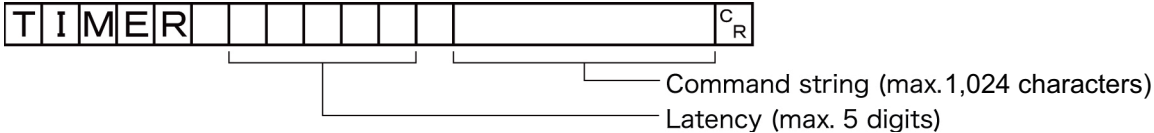

or

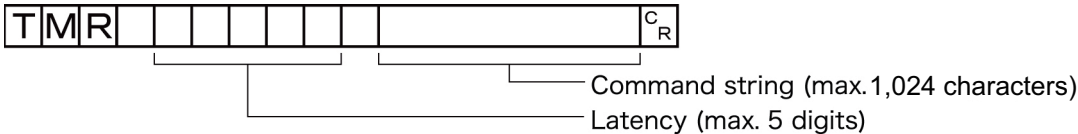

<Response format>

When processing is performed normally:

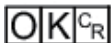

When processing is not performed normally:



<Parameters explanation>

Latency	Specifies the required delay to when the specified command is issued in milliseconds, 100 to 99999.
Command string	Specifies the command string. (Max: 1,024 characters)

(Example)

Getting the current scene number (scene 1) after 3,000 [ms].

<Command>

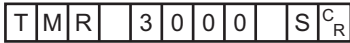

<Response>



UNITDATA or UD

Getting processing unit parameters and measurement values

The set parameters and measurement values for the processing units set in the scene currently being used are got.

<Command format>

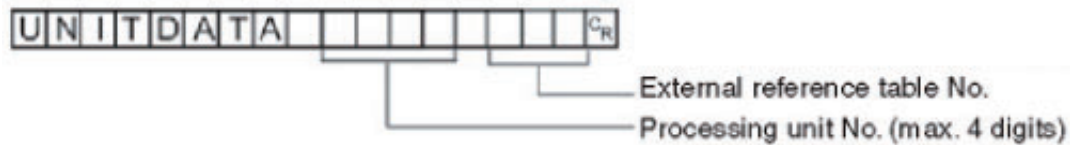

<Response format>

When processing is performed normally:

Measurement value ^{C_R}
OK ^{C_R}

When processing is not performed normally:

ER ^{C_R}

<Parameters explanation>

Processing unit No.	Specifies the processing unit number (0 to the number of unit items -1).
External reference table No.	Varies depending on the specified processing unit processing items. For details, refer to <i>External Reference Table</i> for each processing item in the <i>Vision System FH/FHV series Processing Item Function Reference Manual</i> (Cat. No. Z341).
Measurement value	The acquired measurement value is output as a response.

(Example)

Getting the value of the search judgment result (external reference No. 0) that was set in processing unit 5 for the judgement OK status:

<Command>

UNITDATA 5 0 ^{C_R}

<Response>

1 ^{C_R}
OK ^{C_R}

Changing processing unit parameters

The set parameters for the processing units set in the scene currently being used are changed.

<Command format>

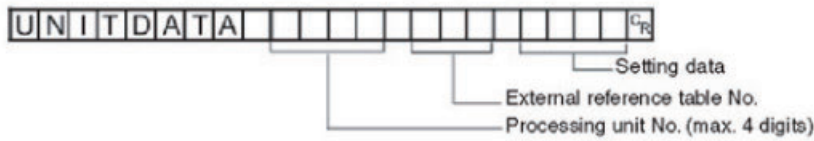

<Response format>

When processing is performed normally:

OK^{CR}

When processing is not performed normally:

ER^{CR}

<Parameters explanation>

Processing unit No.	Specifies the processing unit number (0 to the number of unit items -1).
External reference table No.	Varies depending on the specified processing unit processing items. For details, refer to <i>External Reference Table</i> for each processing item in the <i>Vision System FH/FHV series Processing Item Function Reference Manual</i> (Cat. No. Z341).
Setting Data	Sets the value of the settings data.

(Example)

a. When *Skipping angle* (external reference table No. 124 value) in **Search** set as the 6th processing unit (processing unit number 5) is changed to 10:

<Command>

UNITDATA 5 124 10^{CR}

<Response>

OK^{CR}

b. When *Verification string* (external reference table No. 139 value) in **Character Inspection** set as the 7th processing unit (processing unit number 6) is changed to ABC

<Command>

UNITDATA 6 139 ABC^{CR}

<Response>

OK^{CR}



Additional Information

To set a character string which includes spaces, enclose the character string with " ".

Example:

Setting the character string to compare (value of the external reference table No. 164 value) as "ABC EFG" of the second processing unit (Processing unit No.1).

UNITDATA 1 164 "ABC EFG"

UPDATEMODEL or UMD

Re-registers a model using the current image.

<Command format>

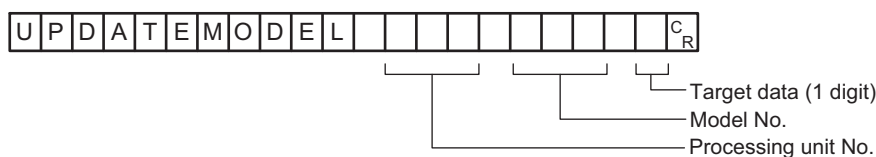

or

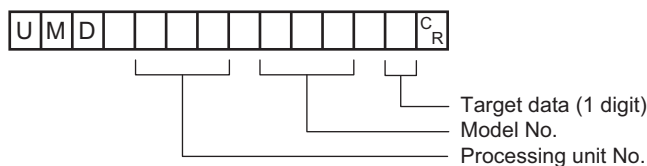

<Response format>

When processing is performed normally:

OK^{C_R}

When processing is not performed normally:

ER^{C_R}

<Parameters explanation>

Processing unit No.	Specifies the processing unit number of a model to re-register: 0 to the number of unit items - 1.
Model No.	Specifies the model number to register a model: 0 to the uppermost unit model number in the unit. Specifying a nonexistent model number causes an error.

Target data	<p>Specifies the target data.</p> <p>When the setting value is expressed in binary, if the 1st bit is 1, the model is re-registered.</p> <p>When the setting value is expressed in binary, if the 2nd bit is 1, the reference position is updated.</p> <p>When the setting value is expressed in binary, if the 3rd bit is 1, the detection position is updated.</p> <p>Example)</p> <ul style="list-style-type: none"> • When only re-registering the model: $1 \times 1 + 2 \times 0 + 4 \times 0 = 1$ (setting value) • When only updating the reference position: $1 \times 0 + 2 \times 1 + 4 \times 0 = 2$ (setting value) • When updating or re-registering everything: $1 \times 1 + 2 \times 1 + 4 \times 1 = 7$ (setting value)
-------------	---

(Example)

The following sample command re-registers a model with unit number 3, model number 0 and target data 1:

<Command>

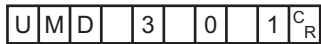

<Response>



USERACCOUNT or UAD

Adds user account to specified user group

Adds the user account to the specified affiliated group ID.

If the user account for the set image is already registered, that setting is overwritten.

<Command format>

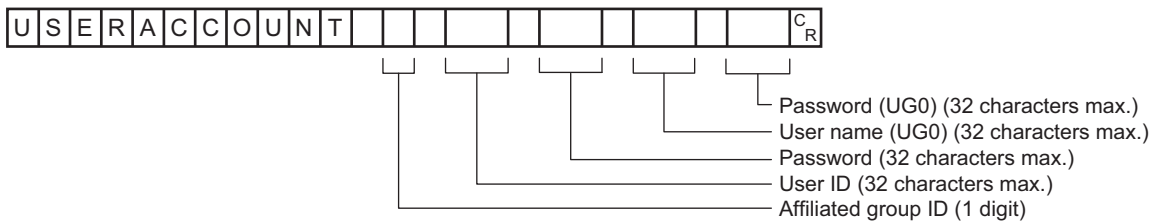

or

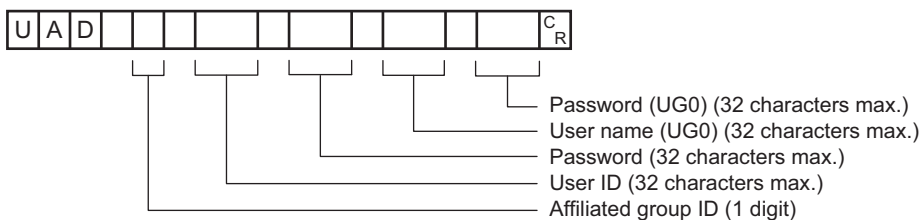

<Response format>

When processing is performed normally:

OK^{CR}

When processing is not performed normally:

ER^{CR}

<Parameters explanation>

User ID	Specifies the user ID of the user to be deleted with up to 32 characters.
User name (UG0)	Specifies the user name for a user belonging to the UG0 group (32 characters maximum).
Password (UG0)	Specifies the password for the above UG0 group user (32 characters maximum).

(Example)

Using the UG0 password *efg* for user *olduser* to delete an account with user name *newuser* with password *abc*:

<Command>

U A D 0 n e w u s e r o l d u s e r e f g ^{CR}

<Response>

OK^{CR}

VERGET

Gets the Sensor Controller version information.

<Command format>

VERGET^{C_R}

<Response format>

When processing is performed normally:

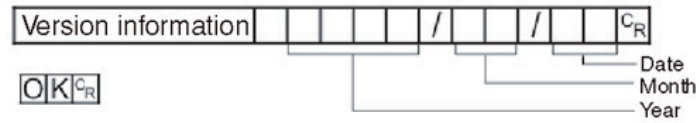

When processing is not performed normally:

ER^{C_R}

<Parameters explanation>

Version information	<ul style="list-style-type: none"> • Sensor Controller model name • Software version
---------------------	--

(Example)

When your software version is 5.00, and the date is *June 1, 2013*:

<Command>

VERGET^{C_R}

<Response>

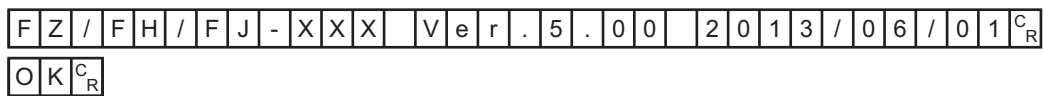

OMRON Corporation Industrial Automation Company

Kyoto, JAPAN

Contact : www.ia.omron.com

Regional Headquarters

OMRON EUROPE B.V.

Wegalaan 67-69, 2132 JD Hoofddorp
The Netherlands
Tel: (31) 2356-81-300 Fax: (31) 2356-81-388

OMRON ASIA PACIFIC PTE. LTD.

438B Alexandra Road, #08-01/02 Alexandra
Technopark, Singapore 119968
Tel: (65) 6835-3011 Fax: (65) 6835-3011

OMRON ELECTRONICS LLC

2895 Greenspoint Parkway, Suite 200
Hoffman Estates, IL 60169 U.S.A.
Tel: (1) 847-843-7900 Fax: (1) 847-843-7787

OMRON (CHINA) CO., LTD.

Room 2211, Bank of China Tower,
200 Yin Cheng Zhong Road,
PuDong New Area, Shanghai, 200120, China
Tel: (86) 21-6023-0333 Fax: (86) 21-5037-2388

Authorized Distributor:

©OMRON Corporation 2013-2024 All Rights Reserved.
In the interest of product improvement,
specifications are subject to change without notice.

Cat. No. Z342-E1-21 0324